



**SOLMANIA**  
International



**SURGICAL  
INSTRUMENT  
CATALOGUE**

[www.solmaniintl.com](http://www.solmaniintl.com)

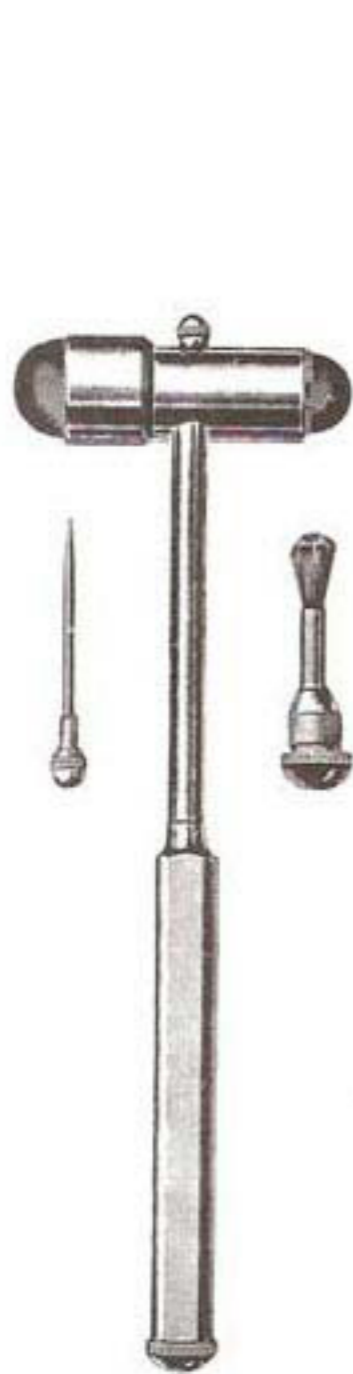

021-006



021-055



021-105  
021-121



021-204



021-206



021-210

021-212



021-208

## DIAGNOSTIC INSTRUMENTS

- 021-006 Buck Neurological Hammer, with Brush and Needle, 7"
- 021-055 Rabiner Neurological Hammer, with Brush and Needle, 8"
- 021-105 Taylor Percussion Hammer, Large, 7-1/2"
- 021-121 Taylor Percussion Hammer, Small, 6-1/4"
- 021-204 Wartenberg Pin Wheel, 7-1/4"
- 021-206 DeJerine Percussion Hammer, Plain
- 021-208 DeJerine Percussion Hammer, with Foot Pin
- 021-210 Flexible Stainless Ruler, Graduated in Inches & mm, 6"x1/2"
- 021-212 Flexible Stainless Ruler, Graduated in Inches & mm, 12"x1/2"



## DIAGNOSTIC INSTRUMENTS



- |          |         |  |
|----------|---------|--|
| <b>A</b> | 021-213 | Combo-5 Neuro Diagnostic Set (C-128 Tuning Fork, Buck Hammer, Pin Wheel, Brush and Needle)                   |
| <b>B</b> | 021-214 | Combo-5 Neuro Diagnostic Set (C-256 Tuning Fork, Buck Hammer, Pin Wheel, Brush and Needle)                   |
| <b>C</b> | 021-216 | Tromner Percussion Hammer 9 3/4", w/Large and Small Rubber Tips, Hollow Tapered Handle w/Sharp Point, Chrome |
| <b>D</b> | 021-755 | Ford Stethoscope w/Shallow Bell and Plastic Ear Tips, Chrome   |
| <b>E</b> | 767-004 | Set of 5 Tuning Forks, C-128, C-256, C-512, C-1024 AND C-2048 In Fitted Case                                 |

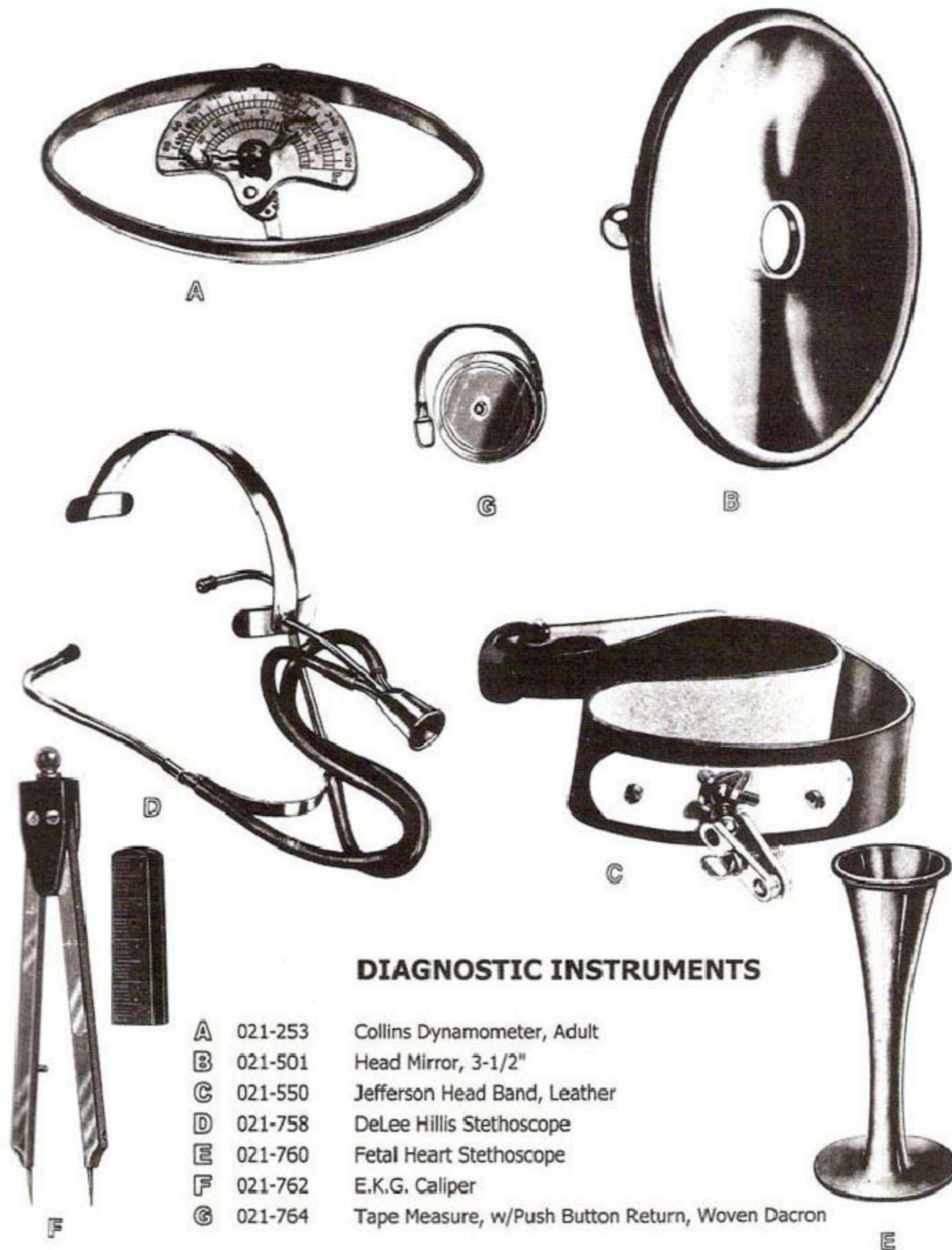

### DIAGNOSTIC INSTRUMENTS

- A 021-253 Collins Dynamometer, Adult
- B 021-501 Head Mirror, 3-1/2"
- C 021-550 Jefferson Head Band, Leather
- D 021-758 DeLee Hillis Stethoscope
- E 021-760 Fetal Heart Stethoscope
- F 021-762 E.K.G. Caliper
- G 021-764 Tape Measure, w/Push Button Return, Woven Dacron



### SCALPEL HANDLES



041-036



041-037



041-038



041-046



041-048



041-079

### SCALPEL HANDLES

- 041-036 Knife Handle No. 3, w/Scale, fitting surgical blades Nos. 10 thru 15
- 041-037 Knife Handle (Smooth) for blades Nos. 60 and 70
- 041-038 Knife Handle No. 3, fitting surgical blades Nos. 10 thru 15
- 041-044 Knife Handle No. 4, w/Scale, fitting surgical blades Nos. 22 thru 25 (no picture displayed)
- 041-046 Knife Handle No. 4, fitting surgical blades Nos. 20 thru 25
- 041-048 Knife Handle (Fluted) for blades Nos. 60 and 70
- 041-079 Knife Handle No. 7, fitting surgical blades Nos. 10 thru 15



## SCALPEL HANDLES



- |          |                |  |
|----------|----------------|--|
| <b>A</b> | <b>041-080</b> | <b>Knife Handle No.9 Fitting Blades 10 thru 15C<br/>Extra fine, Stainless</b>    |
| <b>B</b> | <b>041-081</b> | <b>Siegal Round Knife Handle, Fitting Blades 10 thru 15C<br/>Stainless</b>       |
| <b>C</b> | <b>J41-082</b> | <b>Knife Handle No.5, Fitting Blades 10 thru 15C, Plastic Grip<br/>Stainless</b> |
| <b>D</b> | <b>041-083</b> | <b>Knife Handle No.6, Fitting Blades 20 thru 25, Plastic Grip<br/>Stainless</b>  |
| <b>E</b> | <b>041-084</b> | <b>Self-Locking Chisel Blade Handle, Stainless Steel</b>                         |



# SCALPEL HANDLES



041-086      041-099      041-095      041-101

041-086 Knife Handle # 3L  
041-095 Knife Handle # 4L  
041-099 Knife Handle # 3LA  
041-101 Knife Handle # 4LA



## KNIVES LISTON C

042-655 LISTON Knife, 11-3/4"  
w/ 6-1/2" Blade  
042-754 LISTON Knife, 13-3/4"  
w/ 8" Blade



# Sterile Surgical Blades



Fig. 10



Fig. 11



Fig. 12



Fig. 15

(FITS HANDLES NOS. 3, 3L, 3LA, 7,9)



Fig. 20



Fig. 21



Fig. 23



Fig. 22



Fig. 24



Fig. 25



Fig. 60

(FITS HANDLES NOS. 4, 4L, 4LA)



Fig. 70

**FEATHER BRAND**  
BOX OF 100 BLADES  
STAINLESS STEEL - STERILE

	BLADE SIZE
052-496	10
052-497	11
052-498	12
052-499	15
052-500	20
052-501	21
052-502	22
052-503	23
052-504	24
052-505	25
052-506	60
052-507	70

**FINE BRAND**  
BOX OF 100 BLADES  
STAINLESS STEEL - STERILE

	BLADE SIZE
052-600	10
052-602	11
052-604	12
052-606	15
052-608	20
052-610	21
052-612	22
052-614	23
052-616	24
052-618	25
052-620	60
052-622	70



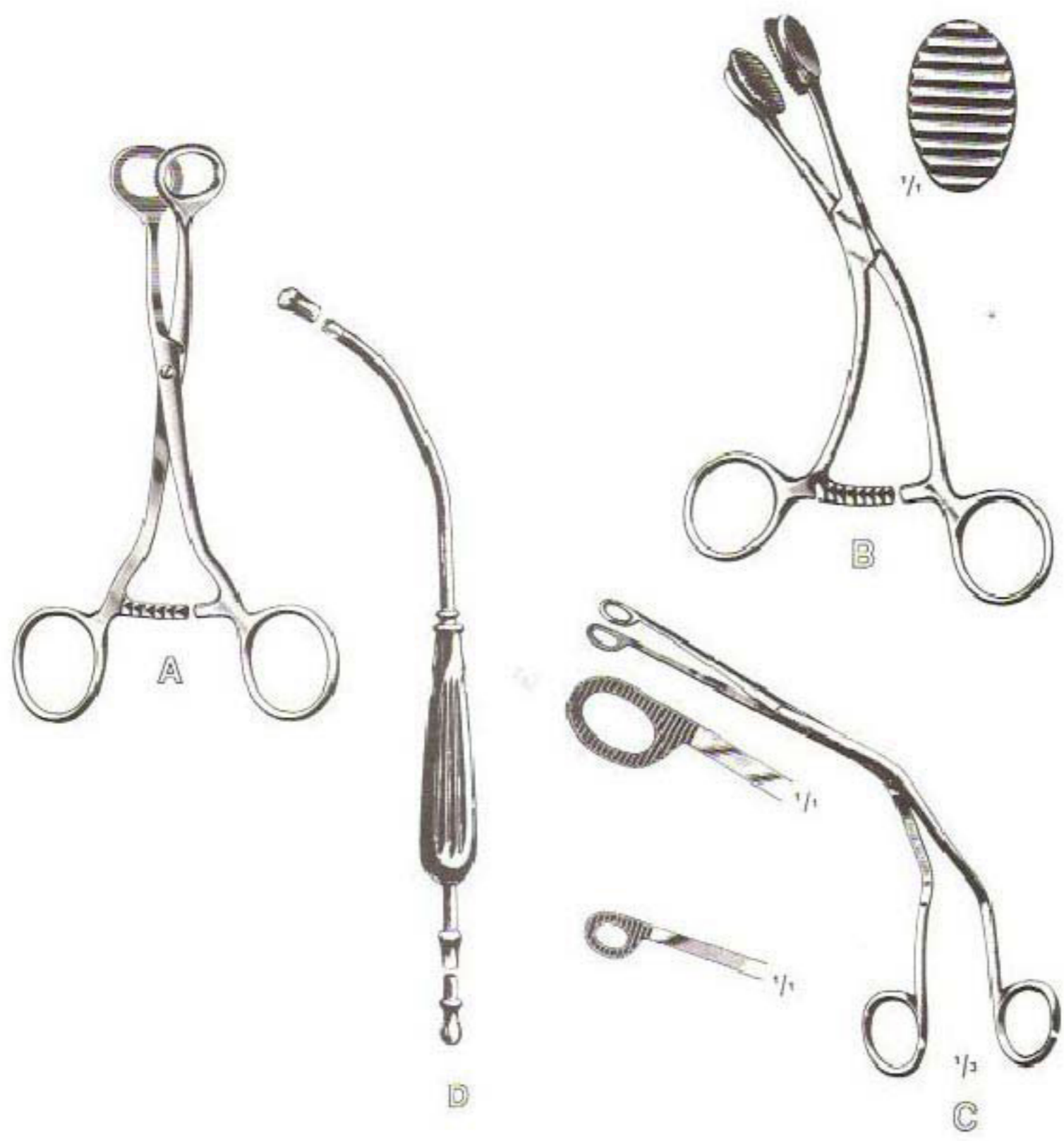

### ANESTHESIA INSTRUMENTS

- A 061-002 Collins Tongue Forceps, 6-1/4"
- B 061-051 Young Tongue Forceps, 6-1/4"  
061-077 Young Rubber Jaws Only, Set of 2
- C 061-770 Magill Catheter Introducing Forceps, Child, 7-1/2"  
061-796 Magill Catheter Introducing Forceps, Adult, 9-3/4"
- D 480-053 Yankauer Suction Tube, Regular, Chrome, 11-3/4"



**McINTOSH  
STANDARD  
LARYNGOSCOPE**

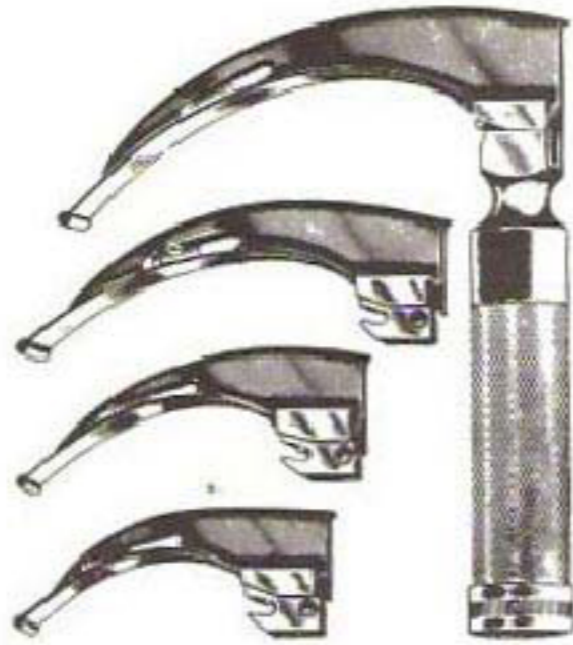
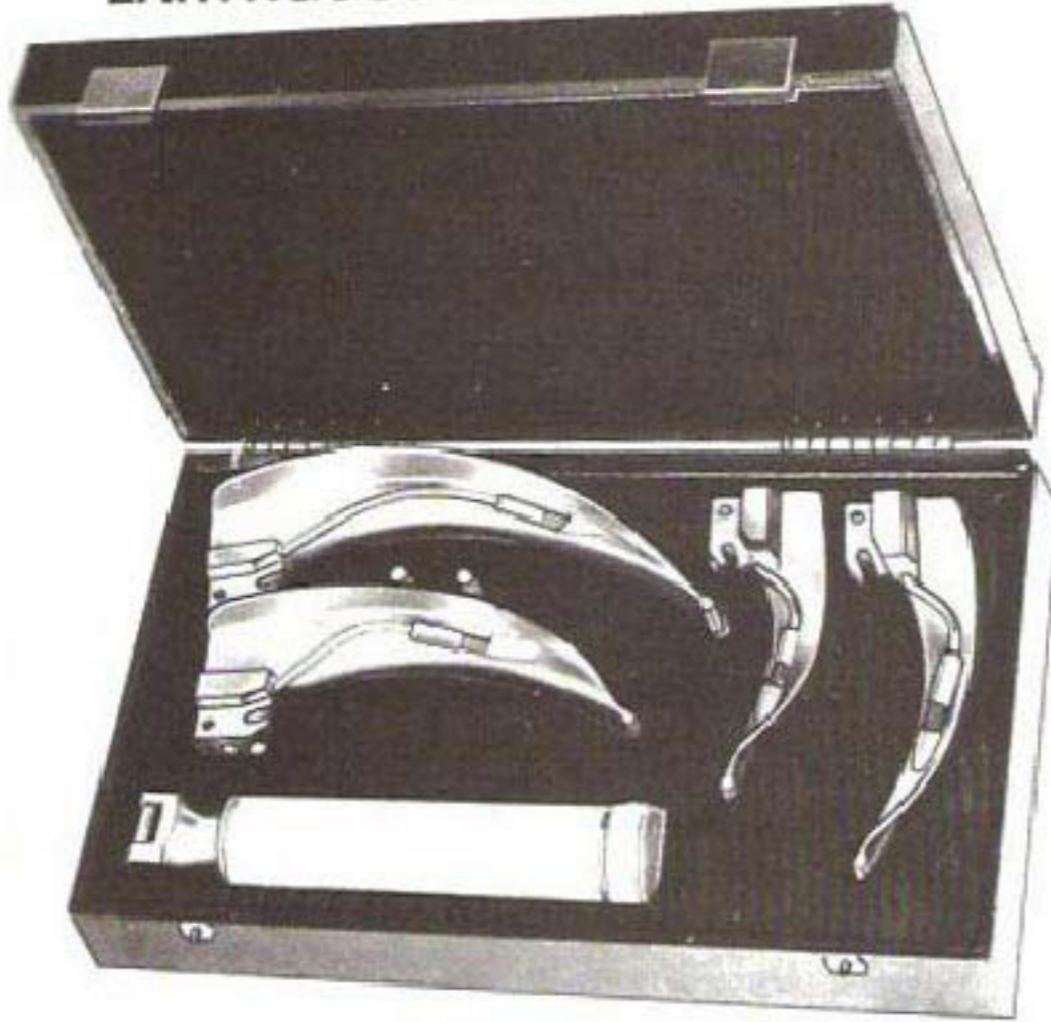

**STANDARD  
McINTOSH  
BLADES**



- 061-820 MCINTOSH Laryngoscope Blades, Stainless, Size 0, Premie
- 061-825 MCINTOSH Laryngoscope Blades, Stainless, Size 1, Infant
- 061-830 MCINTOSH Laryngoscope Blades, Stainless, Size 2, Child
- 061-835 MCINTOSH Laryngoscope Blades, Stainless, Size 3, Medium Adult
- 061-840 MCINTOSH Laryngoscope Blades, Stainless, Size 4, Large Adult
- 061-842 MCINTOSH Laryngoscope Blades, Stainless, Size 5, X-Large Adult



# MILLER

## STANDARD



Fig. 0, 55 mm  
061-845

1/2

## LARYNGOSCOPE

### BLADES

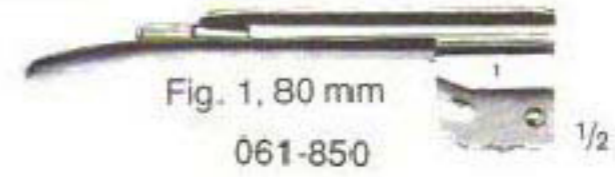

Fig. 1, 80 mm  
061-850

1/2

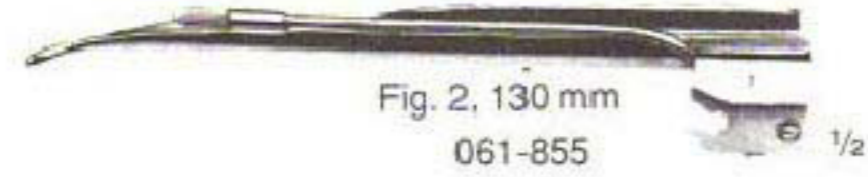

Fig. 2, 130 mm  
061-855

1/2



Fig. 3, 170 mm  
061-860

1/2



Fig. 4, 180 mm  
061-865

1/2

## STANDARD LARYNGOSCOPE HANDLES

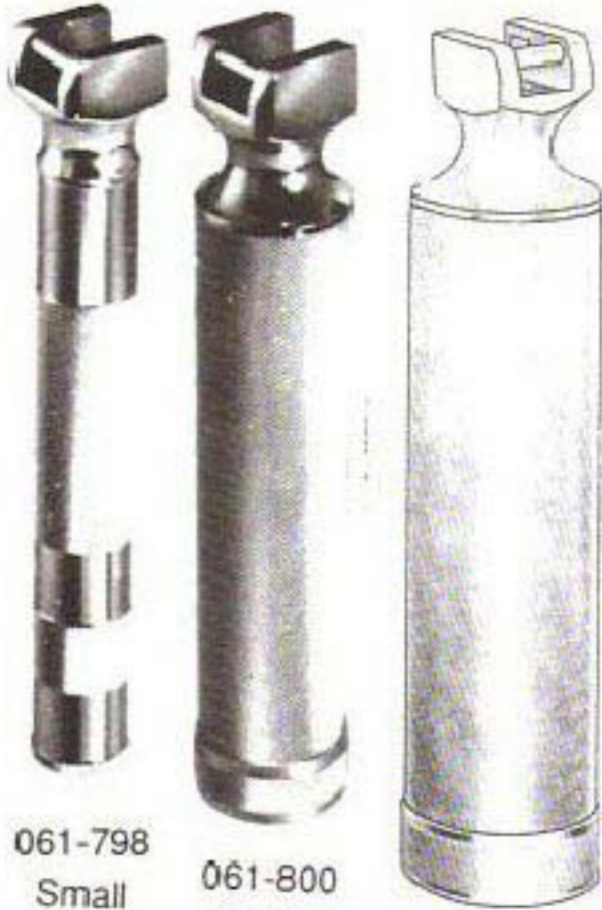

061-798  
Small

061-800  
Medium

061-805  
Large

1/2

## REPLACEMENT LAMPS



Fig. 0-1  
061-810

1/1



Fig. 2-4  
061-815

1/1

- 061-845 MILLER Laryngoscope Blades, Stainless, Size 0, Premie
- 061-850 MILLER Laryngoscope Blades, Stainless, Size 1, Infant
- 061-855 MILLER Laryngoscope Blades, Stainless, Size 2, Child
- 061-860 MILLER Laryngoscope Blades, Stainless, Size 3, Medium Adult
- 061-865 MILLER Laryngoscope Blades, Stainless, Size 4, Large Adult
  
- 061-798 Laryngoscope Handle, Small ("AA" Cell)
- 061-800 Laryngoscope Handle, Medium ("C" Cell)
- 061-805 Laryngoscope Handle, Large ("D Cell")
  
- 061-810 2.5 Volt Bulb, Small (for Sizes 1 & 2 Mac; 0 & 1 Miller)
- 061-815 2.5 Volt Bulb, Large (for Sizes 3 & 4 Mac; 2, 3 & 4 Miller)

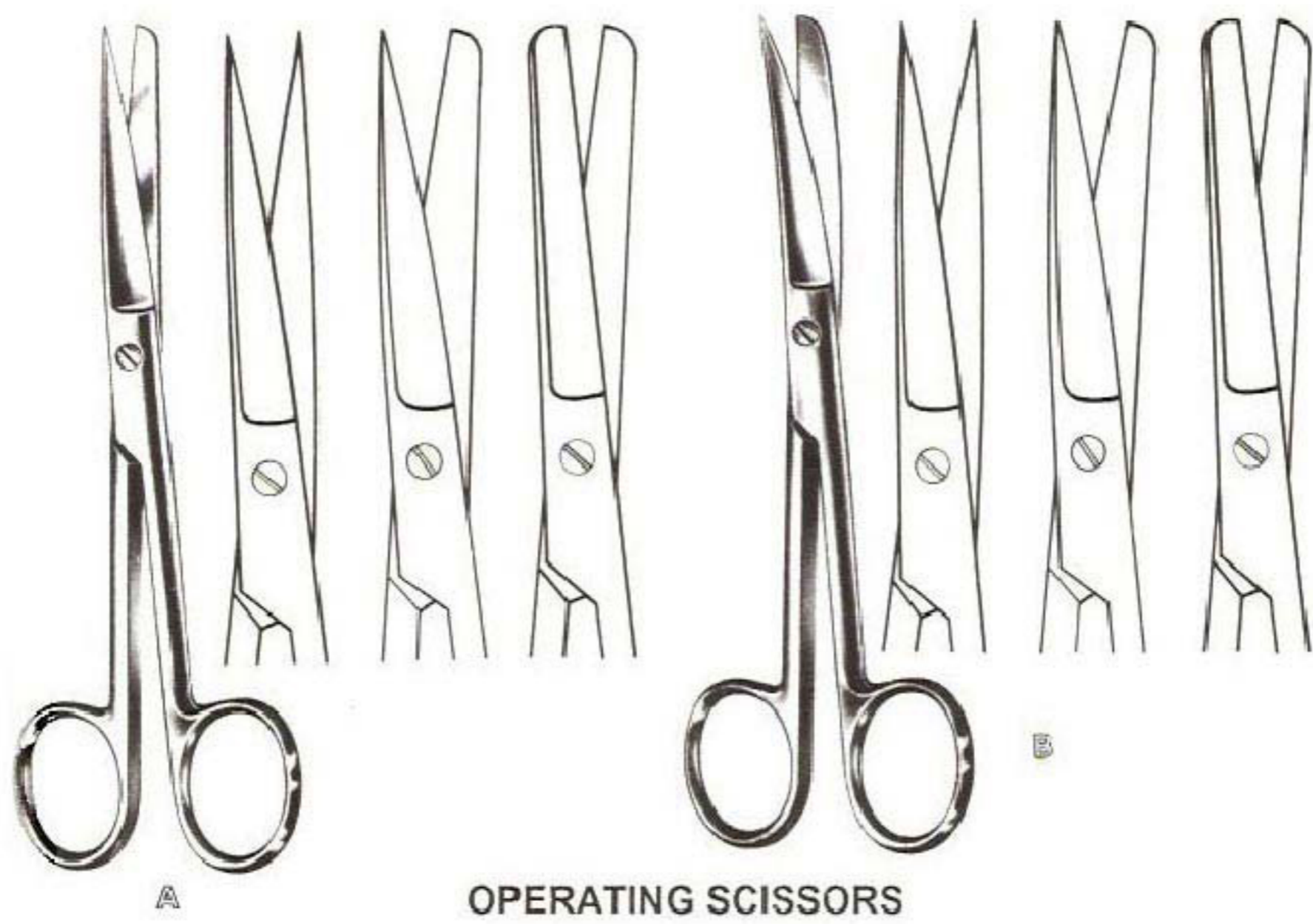

**OPERATING SCISSORS**

A		B	
100-453	Scissors, Straight, Sharp/Blunt, 4-1/2"	100-461	Scissors, Curved, Sharp/Blunt, 4-1/2"
101-451	Scissors, Straight, Sharp/Sharp, 4-1/2"	101-469	Scissors, Curved, Sharp/Sharp, 4-1/2"
102-459	Scissors, Straight, Blunt/Blunt, 4-1/2"	102-467	Scissors, Curved, Blunt/Blunt, 4-1/2"
100-503	Scissors, Straight, Sharp/Blunt, 5"	100-511	Scissors, Curved, Sharp/Blunt, 5"
101-501	Scissors, Straight, Sharp/Sharp, 5"	101-504	Scissors, Curved, Sharp/Sharp, 5"
102-509	Scissors, Straight, Blunt/Blunt, 5"	102-517	Scissors, Curved, Blunt/Blunt, 5"
100-552	Scissors, Straight, Sharp/Blunt, 5-1/2"	100-560	Scissors, Curved, Sharp/Blunt, 5-1/2"
101-550	Scissors, Straight, Sharp/Sharp, 5-1/2"	101-568	Scissors, Curved, Sharp/Sharp, 5-1/2"
102-558	Scissors, Straight, Blunt/Blunt, 5-1/2"	102-566	Scissors, Curved, Blunt/Blunt, 5-1/2"
100-602	Scissors, Straight, Sharp/Blunt, 6-1/2"	100-610	Scissors, Curved, Sharp/Blunt, 6-1/2"
101-600	Scissors, Straight, Sharp/Sharp, 6-1/2"	101-618	Scissors, Curved, Sharp/Sharp, 6-1/2"
102-608	Scissors, Straight, Blunt/Blunt, 6-1/2"	102-616	Scissors, Curved, Blunt/Blunt, 6-1/2"



### Heavy Duty Scissors with One Serrated, Non-Slip Blade

- |          |         |   |
|----------|---------|---|
| <b>A</b> | 100-580 | Moleskin and Felt Scissors, 7 ½" (19.1cm), Sharp/Blunt Points, Straight |
|          | 100-585 | Moleskin and Felt Scissors, 7 ½" (19.1cm), Sharp/Blunt Points, Curved   |
| <b>B</b> | 100-590 | Utility Scissors, 6 ½" (16.5cm), Sharp/Blunt Points, Straight           |
|          | 100-592 | Utility Scissors, 6 ½" (16.5cm), Blunt/Blunt Points, Straight           |
|          | 100-594 | Utility Scissors, 6 ½" (16.5cm), Sharp/Blunt Points, Curved             |
|          | 100-596 | Utility Scissors, 6 ½" (16.5cm), Blunt/Blunt Points, Curved             |



## OPERATING SCISSORS

- |          |         |   |
|----------|---------|---|
| <b>A</b> | 103-002 | Deaver Scissors, Straight, Sharp/Blunt, 5 1/2"                              |
|          | 103-010 | Deaver Scissors, Straight, Sharp/Sharp, 5 1/2"                              |
| <b>B</b> | 103-051 | Deaver Scissors, Curved, Sharp/Blunt, 5 1/2"                                |
|          | 103-069 | Deaver Scissors, Curved, Sharp/Sharp, 5 1/2"                                |
|          | 103-259 | Iris Scissors, Straight, Sharp/Sharp, 4 1/2"                                |
|          | 103-309 | Iris Scissors, Straight, Sharp/Blunt, 4 1/2"                                |
|          | 103-408 | Iris Scissors, Straight, Blunt/Blunt, 4 1/2"                                |
|          | 103-267 | Iris Scissors, Curved, Sharp/Sharp, 4 1/2"                                  |
|          | 103-317 | Iris Scissors, Curved, Sharp/Blunt, 4 1/2"                                  |
|          | 103-416 | Iris Scissors, Curved, Blunt/Blunt, 4 1/2"                                  |
| <b>E</b> | 103-420 | Knapp Iris Scissors, Straight, Sharp/Blunt Points, 4"                       |
|          | 103-422 | Knapp Iris Scissors, Straight, Blunt/Blunt Points, 4"                       |
|          | 103-424 | Knapp Iris Scissors, Curved, Sharp/Blunt Points, 4"                         |
|          | 103-426 | Knapp Iris Scissors, Curved, Blunt/Blunt Points, 4"                         |
| <b>F</b> | 103-428 | Barraquer Iris Scissors, 2 1/4" (5.7cm), Angled<br>7mm Blades, Blunt Points |
|          | 103-430 | Barraquer Iris Scissors, 2 1/4" (5.7cm), Angled<br>7mm Blades, Blunt Points |



103-500  
103-503

A

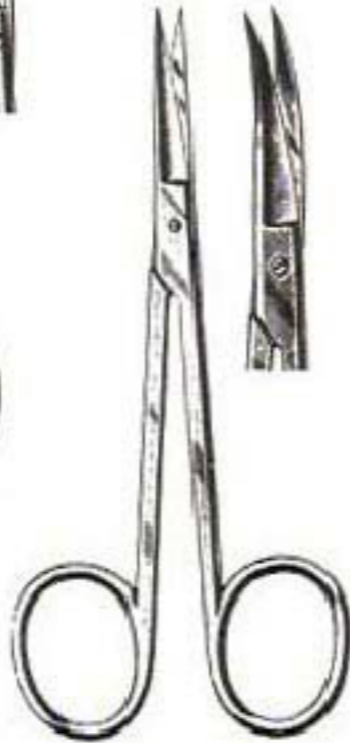

103-507  
103-515

B



103-518  
103-520

C



103-634

D

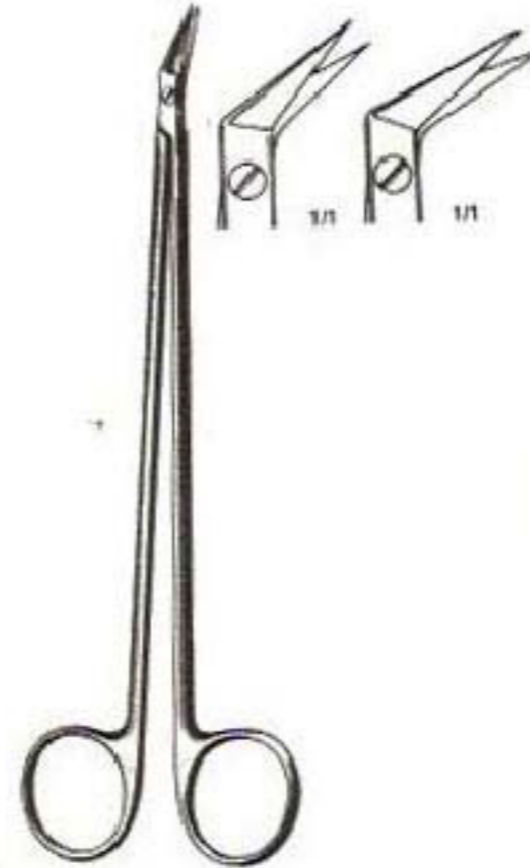

104-000  
104-059  
104-109

E



104-158  
104-166  
104-174

F

## OPERATING SCISSORS

- |   |         |  |
|---|---------|--|
| A | 103-500 | Micro Iris Scissors, 4" Straight, Sharp Points         |
|   | 103-503 | Micro Iris Scissors, 4" Curved, Sharp Points           |
| B | 103-507 | Iris Scissors, Delicate, Straight, Sharp/Sharp, 4-1/4" |
|   | 103-515 | Iris Scissors, Delicate, Curved, Sharp/Sharp, 4-1/4"   |
| C | 103-518 | Iris Scissors, Straight, Sharp, Delicate, 4-1/2"       |
|   | 103-520 | Iris Scissors, Curved, Sharp, Delicate, 4-1/2"         |
| D | 103-634 | Iris Scissors, Angular, Sharp/Sharp, 4-1/2"            |
| E | 104-000 | Potts-Smith Scissors, 25°, 7-1/2"                      |
|   | 104-059 | Potts-Smith Scissors, 45°, 7-1/2"                      |
|   | 104-109 | Potts-Smith Scissors, 60°, 7-1/2"                      |
| F | 104-158 | Kelly Scissors, Straight, Sharp/Points, 6-1/4"         |
|   | 104-166 | Kelly Scissors, Curved, Sharp/Points, 6-1/4"           |
|   | 104-174 | Kelly Scissors, Angled on Side, Sharp/Points, 6-1/4"   |



## OPERATING SCISSORS

- |          |         |   |
|----------|---------|---|
| <b>A</b> | 744-296 | Strabismus Scissors, 4", Straight   |
|          | 744-298 | Strabismus Scissors, 4", Curved   |
|          | 744-300 | Strabismus Scissors, 4 ½", Straight   |
|          | 744-318 | Strabismus Scissors, 4 ½", Curved   |
| <b>B</b> | 104-200 | Goldman-Fox Wound Debridement Scissors, 5", Curved, Fine Tips<br>One Serrated Blade     |
|          | 104-205 | Goldman-Fox Wound Debridement Scissors, 5", Curved<br>One Serrated Blade, Angled Shanks |
| <b>C</b> | 104-220 | LaGrange Scissors, 4 ¼", Curved, One Blade Serrated Angled Shanks                       |
|          | 822-106 | Foman Lower Lateral Scissors, 5", Strong Curve, Dissection Blade                        |
|          | 822-155 | Foman Dorsal Scissors, 5 ½", Light Pattern, Angular Shanks                              |
|          | 822-156 | Quimby Scissors, 5", Strongly Curved and Pointed  |
|          | 822-157 | Quimby Scissors, 5", Strongly Curved and Pointed, One Serrated Blade                    |





104-505  
A

825-260  
D

764-104  
G

104-554  
B

104-608  
C

104-610  
C

941-005  
941-008

### OPERATING SCISSORS



965-558  
E



965-583  
F

- I A 104-505
- 104-525
- 104-528
- B 104-554
- C 104-608
- 104-610
- G 764-104
- D 825-260
- I 941-005
- 941-008
- 942-102
- E 965-558
- F 965-583

- Douglas (Thorek) Scissors, 8 3/4"
- Thorek Scissors, Full Curved, 7 1/4"
- Thorek Scissors, Full Curved, 10"
- Ferguson Abdominal Scissors, 7"
- Willauer Thoracic Scissors, Straight, 11 1/2"
- Willauer Thoracic Scissors, Curved, 11 1/2"
- Bellucci Micro Ear Scissors, 2 3/4" Shaft  
4mm Blade, Ebony Finish
- Knight Nasal Scissors, 6 3/4", Angled on Flat
- Braun Episiotomy Scissors, 5 3/4"
- Braun Episiotomy Scissors, 8 1/2"
- Umbilical Scissors, 4 1/8", American Pattern
- Enterotomy Scissors, with Probe Tip, 8"
- Enterotomy Scissors, with Hook, 9"



## OPERATING SCISSORS

- |          |         |   |
|----------|---------|---|
| <b>A</b> | 104-612 | Plastic Surgery Scissors, 4 3/4" (12.1 cm), Straight, Sharp/Sharp Points                |
|          | 104-614 | Plastic Surgery Scissors 4 3/4" (12.1 cm), Straight, Sharp/Sharp Points Serrated Blades |
|          | 104-624 | Plastic Surgery Scissors 4 3/4" (12.1 cm), Straight, Sharp/Blunt Points                 |
|          | 104-626 | Plastic Surgery Scissors 4 3/4" (12.1 cm), Straight, Sharp/Blunt Points Serrated Blades |
|          | 104-628 | Plastic Surgery Scissors 4 3/4" (12.1 cm), Straight, Blunt/Blunt Points                 |
|          | 104-630 | Plastic Surgery Scissors 4 3/4" (12.1 cm), Straight, Blunt/Blunt Points Serrated Blades |
| <b>B</b> | 104-632 | Plastic Surgery Scissors, 4 3/4" (12.1 cm), Curved, Sharp/Sharp Points                  |
|          | 104-634 | Plastic Surgery Scissors 4 3/4" (12.1 cm), Curved, Sharp/Sharp Points Serrated Blades   |
|          | 104-636 | Plastic Surgery Scissors, 4 3/4" (12.1 cm), Curved, Sharp/Blunt Points                  |
|          | 104-638 | Plastic Surgery Scissors 4 3/4" (12.1 cm), Curved, Sharp/Blunt Points Serrated Blades   |
|          | 104-640 | Plastic Surgery Scissors, 4 3/4" (12.1 cm), Curved, Blunt/Blunt Points                  |
|          | 104-642 | Plastic Surgery Scissors 4 3/4" (12.1 cm), Curved, Blunt/Blunt Points Serrated Blades   |



## OPERATING SCISSORS

A	104-616	Reynolds Dissecting Scissors 6" (15.2 cm), Straight Tenotomy Type Dissecting Tips
	104-618	Reynolds Dissecting Scissors 6" (15.2cm), Curved Tenotomy Type Dissecting Tips
B	104-620	Reynolds Dissecting Scissors 7" (17.8cm), Straight Tenotomy Type Dissecting Tips
	104-622	Reynolds Dissecting Scissors 7" (17.8cm), Curved Tenotomy Type Dissecting Tips
C	105-302	Ragnell Dissecting Scissors 5" (12.7 cm), Flat Tip, Straight
	105-304	Ragnell Dissecting Scissors 5" (12.7 cm), Flat Tip, Curved
D	105-306	Ragnell Dissecting Scissors 7" (17.8 cm), Flat, Straight
	105-308	Ragnell Dissecting Scissors 7" (17.8 cm), Flat, Curved



### OPERATING SCISSORS

- |          |         |  |
|----------|---------|--|
| <b>A</b> | 104-644 | Sistrunk Scissors 5 ½" (14 cm), Straight                         |
| <b>B</b> | 104-646 | Sistrunk Scissors 5 ½" (14 cm), Slightly Curved                  |
| <b>C</b> | 822-304 | Wire Cutting Scissors 4 ¾" (12 cm), Straight, one Blade Serrated |
| <b>D</b> | 822-353 | Wire Cutting Scissors 4 ¾" (12 cm), Curved, one Blade Serrated   |



105-007  
105-056  
105-106



105-015  
105-064  
105-114

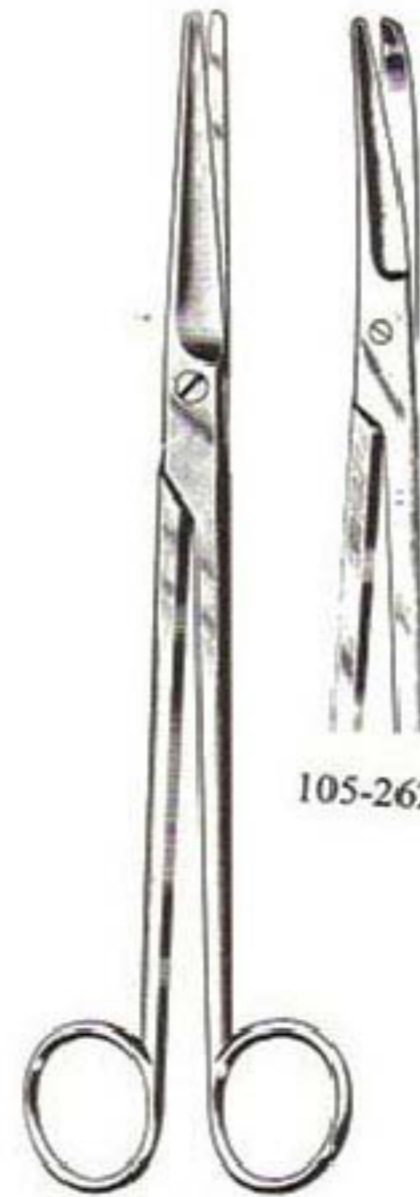

105-260

105-262

## OPERATING SCISSORS



D  
105-270

- |          |         |   |
|----------|---------|---|
| <b>A</b> | 105-007 | SIMS Scissors 8" (20.3 cm), straight, sharp-sharp points  |
|          | 105-056 | SIMS Scissors, 8" (20.3 cm), straight, sharp-blunt points |
|          | 105-106 | SIMS Scissors, 8" (20.3 cm), straight, blunt-blunt points |
| <b>B</b> | 105-015 | SIMS Scissors, 8" (20.3 cm), curved, sharp-sharp points   |
|          | 105-064 | SIMS Scissors, 8" (20.3 cm), curved, sharp-blunt points   |
|          | 105-114 | SIMS Scissors, 8" (20.3 cm), curved, blunt-blunt points   |
| <b>C</b> | 105-260 | Mayo Harrington Scissors, Straight, 11" (29.2 cm)         |
|          | 105-262 | Mayo Harrington Scissors, Curved, 11" (29.2 cm)           |
| <b>D</b> | 105-270 | SATINSKY Scissors, 10" (25.4 cm), S-curved                |

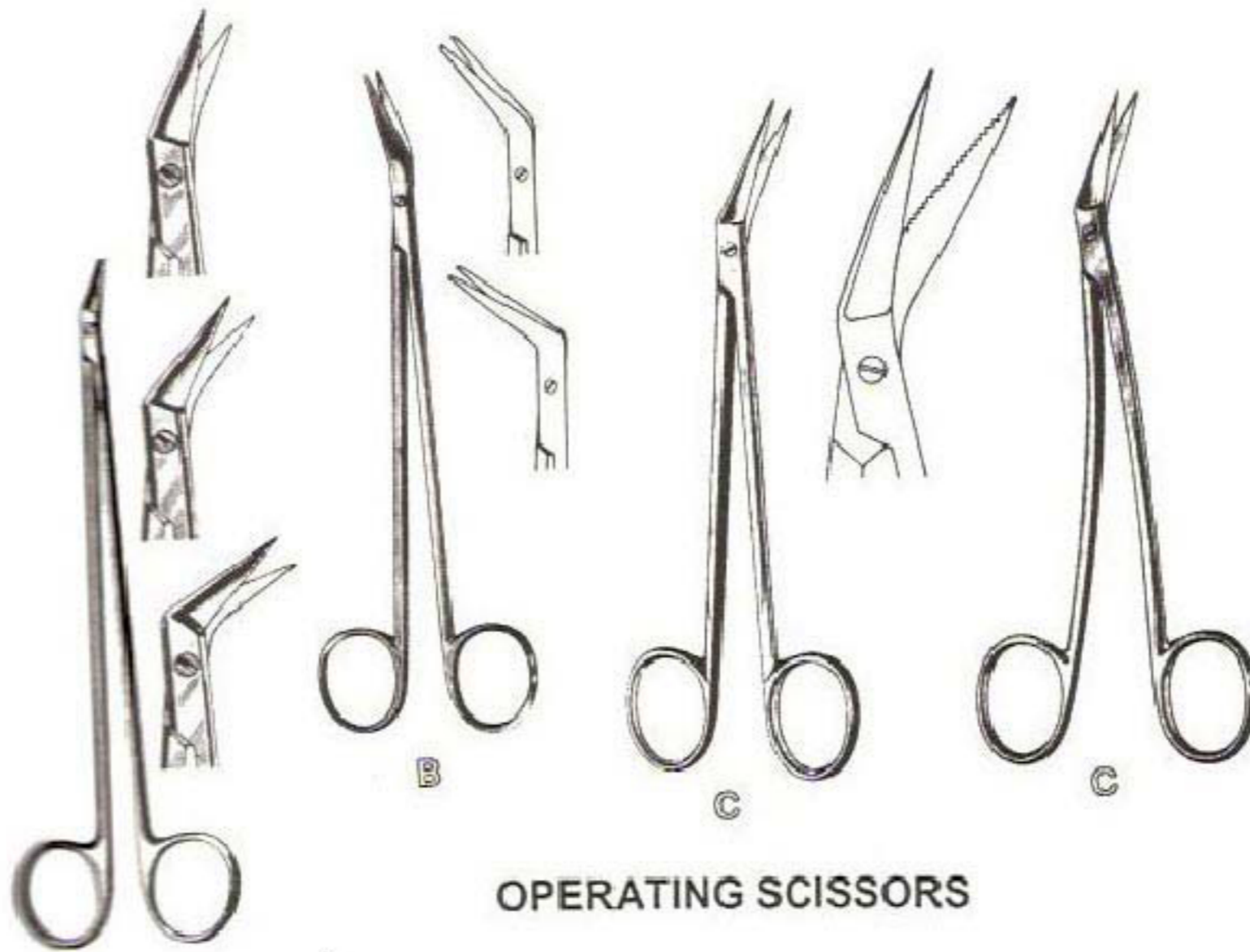

## OPERATING SCISSORS

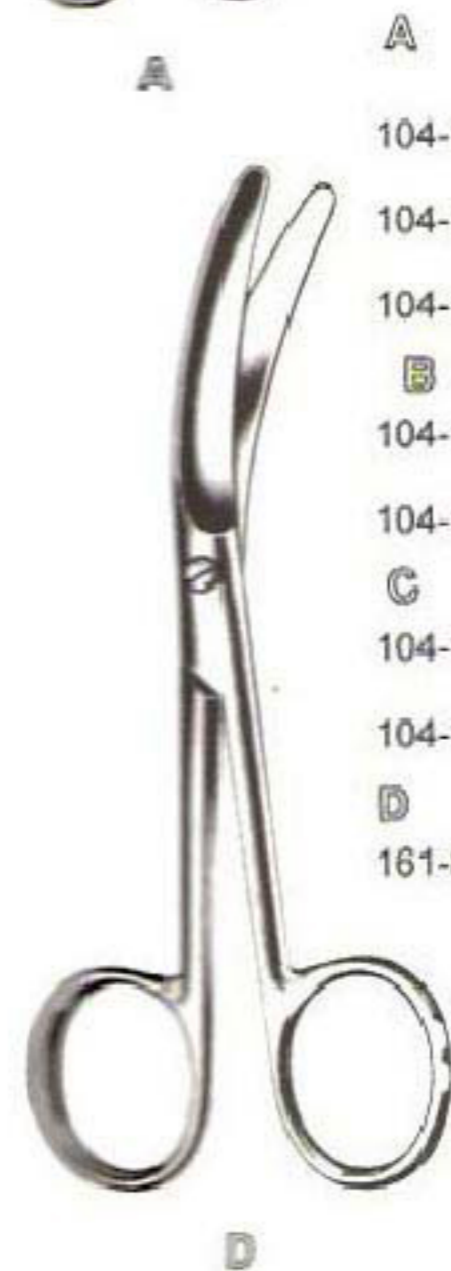

**A**

- 104-110 POTTS-SMITH Scissors, 7" (17.8 cm), delicate, angled on side 25 degrees, 13 mm blades
- 104-112 POTTS-SMITH Scissors, 7" (17.8 cm), delicate, angled on side 45 degrees, 13 mm blades
- 104-114 POTTS-SMITH Scissors, 7" (17.8 cm), delicate, angled on side 60 degrees, 13 mm blades

**B**

- 104-118 DEBAKEY-POTTS Scissors, 6-3/4" (17.1 cm), blunt tips, angled on side 45 degrees
- 104-120 DEBAKEY-POTTS Scissors, 6-3/4" (17.1 cm), blunt tips, angled on side 60 degrees

**C**

- 104-122 LOCKLIN Operating Scissors, 6-1/4" (15.9 cm), angled on side 25 degrees, one serrated blade
- 104-124 LOCKLIN Operating Scissors, 6-1/4" (15.9 cm), curved shank, angled on side 25 degrees, one serrated blade

**D**

- 161-815 BUSCH Umbilical Scissors, 6-1/2" (16.5 cm), curved on side

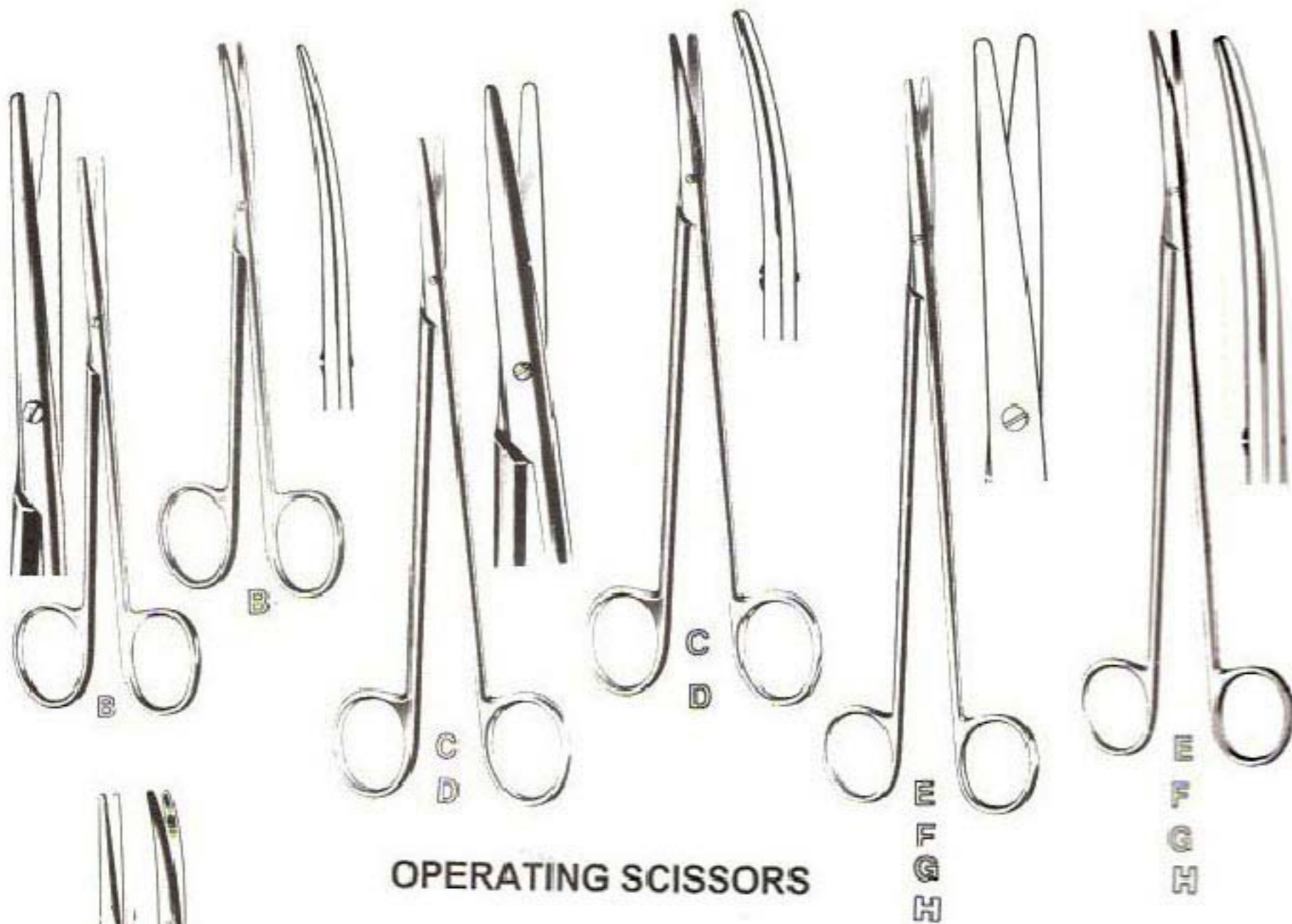

### OPERATING SCISSORS



- |          |         |   |
|----------|---------|---|
| <b>A</b> | 105-546 | METZENBAUM Scissors, Straight, 5" (12.7 cm)           |
|          | 105-548 | METZENBAUM Scissors, Curved, 5" (12.7 cm)             |
| <b>B</b> | 105-551 | METZENBAUM (Lahey) Scissors, 5-1/2" (14 cm), Straight |
|          | 105-569 | METZENBAUM (Lahey) Scissors, 5-1/2" (14 cm), Curved   |
| <b>C</b> | 105-700 | METZENBAUM Scissors, 7" (17.8 cm), Straight           |
|          | 105-718 | METZENBAUM Scissors, 7" (17.8 cm), Curved             |
| <b>D</b> | 105-809 | METZENBAUM (Nelson) Scissors, 8" (20.3 cm), Straight  |
|          | 105-817 | METZENBAUM (Nelson) Scissors, 8" (20.3 cm), Curved    |
| <b>E</b> | 105-908 | METZENBAUM (Nelson) Scissors, 9" (22.9 cm), Straight  |
|          | 105-916 | METZENBAUM (Nelson) Scissors, 9" (22.9 cm), Curved    |
| <b>F</b> | 105-918 | METZENBAUM (Nelson) Scissors, 10" (25 cm), Straight   |
|          | 105-920 | METZENBAUM (Nelson) Scissors, 10" (25 cm), Curved     |
| <b>G</b> | 106-012 | METZENBAUM (Nelson) Scissors, 11" (27.9 cm), Straight |
|          | 106-013 | METZENBAUM (Nelson) Scissors, 11" (27.9 cm), Curved   |
| <b>H</b> | 106-015 | METZENBAUM (Nelson) Scissors, 12" (30 cm), Straight   |
|          | 106-018 | METZENBAUM (Nelson) Scissors, 12" (30 cm), Curved     |



## OPERATING SCISSORS

- |          |         |  |
|----------|---------|--|
| <b>A</b> | 106-550 | Dissecting Scissors, 4" (10.2 cm), Straight, Dissecting Tips           |
|          | 106-555 | Dissecting Scissors, 4" (10.2 cm), Curved, Dissecting Tips             |
| <b>B</b> | 744-072 | WILMER Conjunctival and Utility Scissors, 4" (10.2 cm), angled on flat |
| <b>C</b> | 744-074 | BONN Miniature Iris Scissors, 3-1/2" (8.9 cm), straight                |
|          | 744-076 | BONN Miniature Iris Scissors, 3-1/2" (8.9 cm), curved                  |
| <b>D</b> | 744-250 | STEVENS Tenotomy Scissors, 4-1/2" (11.4 cm), straight, sharp points    |
|          | 744-255 | STEVENS Tenotomy Scissors, 4-1/2" (11.4 cm), straight, blunt points    |
| <b>E</b> | 744-268 | STEVENS Tenotomy Scissors, 4-1/2" (11.4 cm), curved, sharp points      |
|          | 744-270 | STEVENS Tenotomy Scissors, 4-1/2" (11.4 cm), curved, blunt point       |





## OPERATING SCISSORS

- |          |         |   |
|----------|---------|---|
| <b>A</b> | 106-644 | Long Oral Surgery Stitch Scissors 6" (15.2 cm)                                    |
| <b>B</b> | 106-646 | Crown Stitch Scissors 4 ½" (11.4 cm) Angled, Delicate                             |
|          | 106-648 | O'Brien Stitch Scissors 3 ¾" (9.5 cm) Angled, Sharp Points                        |
| <b>C</b> | 744-003 | Iris Scissors 4 ½" (11.4 cm), Curved Sideways                                     |
| <b>D</b> | 104-220 | La Grange Scissors 4 ¼" (10.8 cm), Curved, One Serrated Blade Angled Shanks       |
| <b>E</b> | 161-005 | Knowles Bandage Scissors 5 ½" (14 cm), Shanks Angled on Side, Serrated Blades     |
| <b>F</b> | 842-054 | Dean Dissecting Scissors 6 ¾" (17.1 cm), Blades Angled on Flat One Serrated Blade |



### OPERATING SCISSORS



- A** 106-559 Mayo Dissecting Scissors, Straight, 5 1/2"
- B** 106-567 Mayo Dissecting Scissors, Curved, 5 1/2"
- A** 106-757 Mayo Dissecting Scissors, Straight, 6 3/4"
- B** 106-765 Mayo Dissecting Scissors, Curved, 6 3/4"
- C** 106-807 Mayo-Stille Scissors, Straight, Rounded Blades, 5 1/2"
- D** 106-815 Mayo-Stille Scissors, Curved, Rounded Blades, 5 1/2"
- C** 106-856 Mayo-Stille Scissors, Straight, Rounded Blades, 6 3/4"
- D** 106-864 Mayo-Stille Scissors, Curved, Rounded Blades, 6 3/4"
- E** 160-765 Richter Dissecting Scissors, 5", Angular blades  
1 Sharp Blade, 1 Blunt Blade

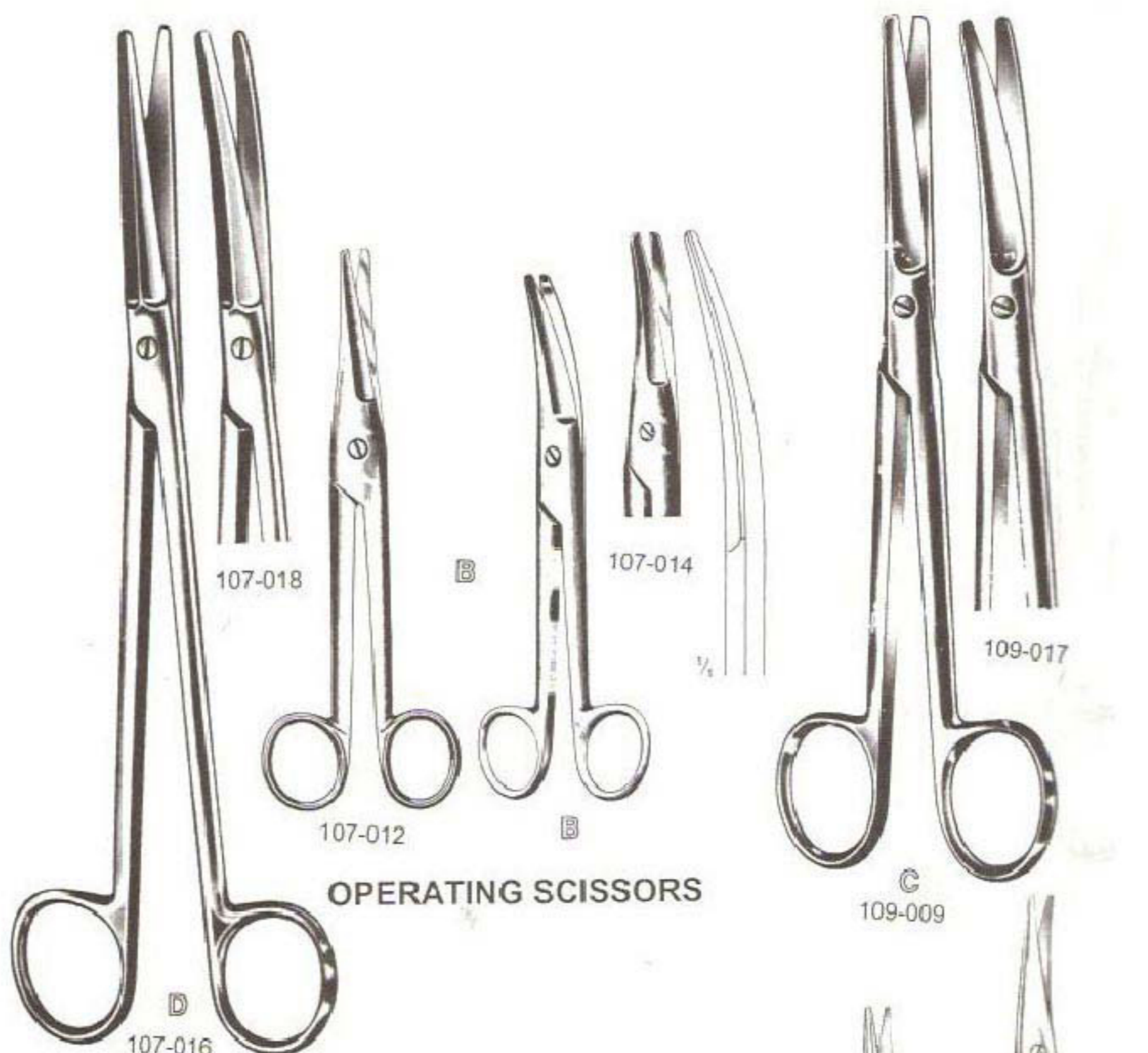

**OPERATING SCISSORS**

- A** 107-003 MAYO-NOBLE Dissecting Scissors, 6-1/2" (16.5 cm), straight, rounded blades
- 107-011 MAYO-NOBLE Dissecting Scissors, 6-1/2" (16.5 cm), curved, rounded blades
- B** 107-012 MAYO-NOBLE Dissecting Scissors, 6-1/2" (16.5 cm), straight, beveled blades
- 107-014 MAYO-NOBLE Dissecting Scissors, 6-1/2" (16.5 cm), curved, beveled blades
- D** 107-016 GORNEY Facelift Scissors, 7-3/4" (19.7 cm), straight, one serrated blade
- 107-018 GORNEY Facelift Scissors, 7-3/4" (19.7 cm), slightly curved blades, one serrated blade
- C** 109-009 MAYO Dissecting Scissors, 9" (22.9 cm), straight, standard beveled blades
- 109-017 MAYO Dissecting Scissors, 9" (22.9 cm), curved, standard beveled blades

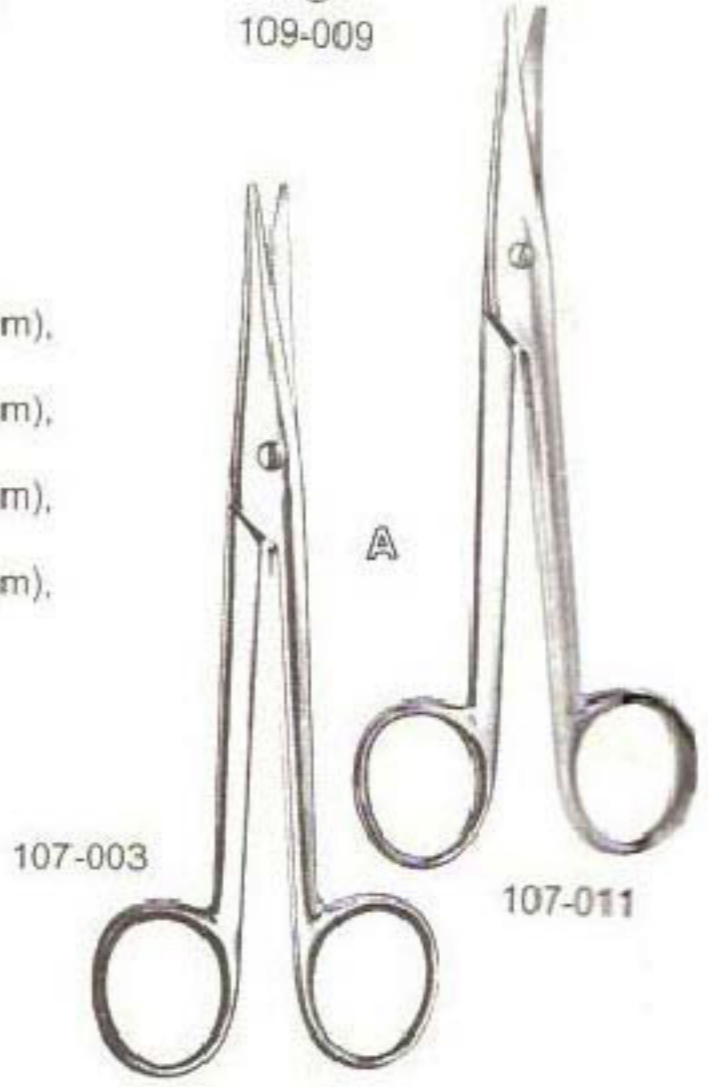



# ***SUPER-CUT-SCISSORS***





# SUPER-CUT-SCISSORS



- |   |         |  |
|---|---------|--|
| A | 170-100 | SuperCut Operating Scissors, 5" (14 cm), straight, sharp/blunt         |
|   | 170-102 | SuperCut Operating Scissors, 5" (14 cm), curved, sharp/blunt           |
|   | 170-104 | SuperCut Operating Scissors, 5-1/2" (14 cm), straight, sharp/blunt     |
|   | 170-106 | SuperCut Operating Scissors, 5-1/2" (14 cm), curved, sharp/blunt       |
| B | 170-108 | SuperCut Iris Scissors, 4-1/2" (11.4 cm), straight                     |
|   | 170-110 | SuperCut Iris Scissors, 4-1/2" (11.4 cm), curved                       |
|   | 180-100 | SuperCut Iris Scissors, 4-1/2" (11.4 cm), straight, Carb-N-Sert blades |
|   | 180-102 | SuperCut Iris Scissors, 4-1/2" (11.4 cm), curved, Carb-N-Sert blades   |



# SUPER-CUT-SCISSORS

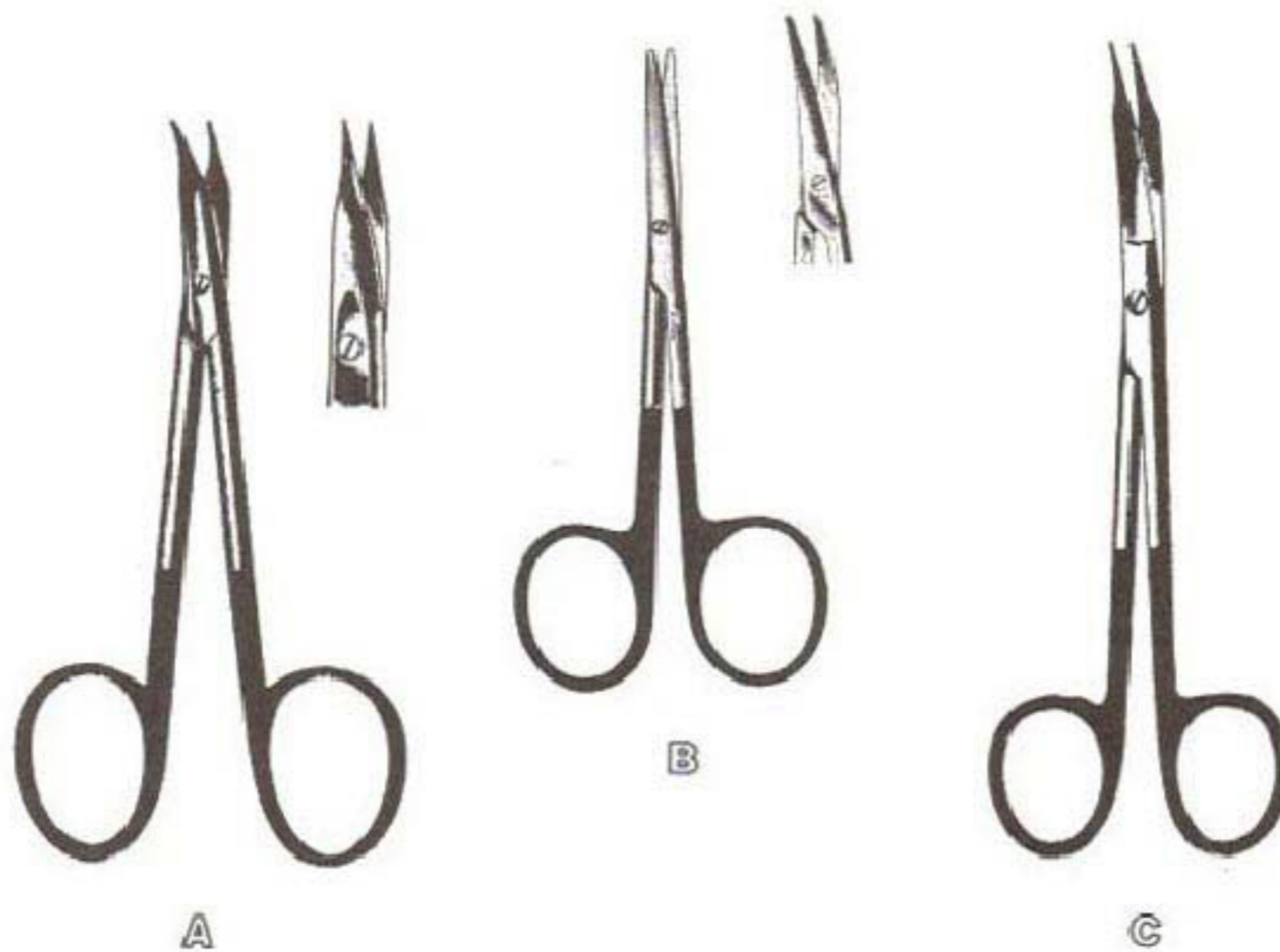

- |   |         |  |
|---|---------|--|
| A | 170-112 | SuperCut STEVENS Tenotomy Scissors, 4-1/2" (11.4 cm), straight |
|   | 170-114 | SuperCut STEVENS Tenotomy Scissors, 4-1/2" (11.4 cm), curved   |
| B | 170-116 | SuperCut Strabismus Scissors, straight, blunt, 4-1/2"          |
|   | 170-118 | SuperCut Strabismus Scissors, curved, blunt, 4-1/2"            |
| C | 170-120 | SuperCut GOLDMAN-FOX Gum Scissors, curved                      |



# SUPER-CUT-SCISSORS



- A**
- 170-122 SuperCut METZENBAUM Scissors, 5-1/2" (14 cm), Straight
  - 170-124 SuperCut METZENBAUM Scissors, 5-1/2" (14 cm), curved
  
  - 170-126 SuperCut METZENBAUM Scissors, 7" (17.8 cm), straight
  - 170-128 SuperCut METZENBAUM Scissors, 7" (17.8 cm), curved
  
  - 170-130 SuperCut METZENBAUM Scissors, 8" (17.8 cm), straight
  - 170-132 SuperCut METZENBAUM Scissors, 8" (17.8 cm), Curved
  
  - 170-134 SuperCut METZENBAUM Scissors, 9" (22.9 cm), Straight
  - 170-136 SuperCut METZENBAUM Scissors, 9" (22.9 cm), curved
  
  - 180-104 SuperCut METZENBAUM Scissors, 7" (17.8 cm), curved, Carb-N-Sert blades
- B**
- 170-138 SuperCut MAYO Scissors, 5-1/2" (14 cm), straight
  - 170-140 SuperCut MAYO Scissors, 5-1/2" (14 cm), curved
  
  - 170-142 SuperCut MAYO Scissors, 6-3/4" (17.1 cm), straight
  - 170-144 SuperCut MAYO Scissors, 6-3/4" (17.1 cm), curved
  - 170-146 SuperCut MAYO Scissors, 9" (22.9 cm), straight
  - 170-148 SuperCut MAYO Scissors, 9" (22.9 cm), curved
  
  - 180-120 SuperCut MAYO Scissors, 9" (22.9 cm), straight, Carb-N-Sert Blades
  - 180-122 SuperCut MAYO Scissors, 9" (22.9 cm), curved, Carb-N-Cert Blades



### OPERATING SCISSORS WITH TUNGSTEN CARBIDE BLADES

A	120-550	Operating Scissors, Straight, Sharp/Blunt, 5 1/2" (14 cm)
	120-558	Operating Scissors, Straight, Sharp/Sharp, 5 1/2" (14 cm)
	120-559	Operating Scissors, Straight, Blunt/Blunt, 5 1/2" (14 cm)
B	121-568	Operating Scissors, Curved, Sharp/Blunt, 5 1/2" (14 cm)
	121-569	Operating Scissors, Curved, Sharp/Sharp, 5 1/2" (14 cm)
	121-570	Operating Scissors, Curved, Blunt/Blunt, 5 1/2" (14 cm)
C	123-257	Iris Scissors, Straight, 4 1/2"
	123-265	Iris Scissors, Curved, 4 1/2"





### OPERATING SCISSORS WITH TUNGSTEN CARBIDE BLADES

- A** 124-412 Strabismus Scissors, 4-1/2" (11.4 cm), straight, TC-blades
- 124-985 Strabismus Scissors, 4-1/2" (11.4 cm), curved, TC-blades
  
- B** 125-559 METZENBAUM (Lahey) Scissors, 5-1/2" (14 cm), straight, TC-blades
- C** 125-567 METZENBAUM (Lahey) Scissors, 5-1/2" (14 cm), curved, TC-blades

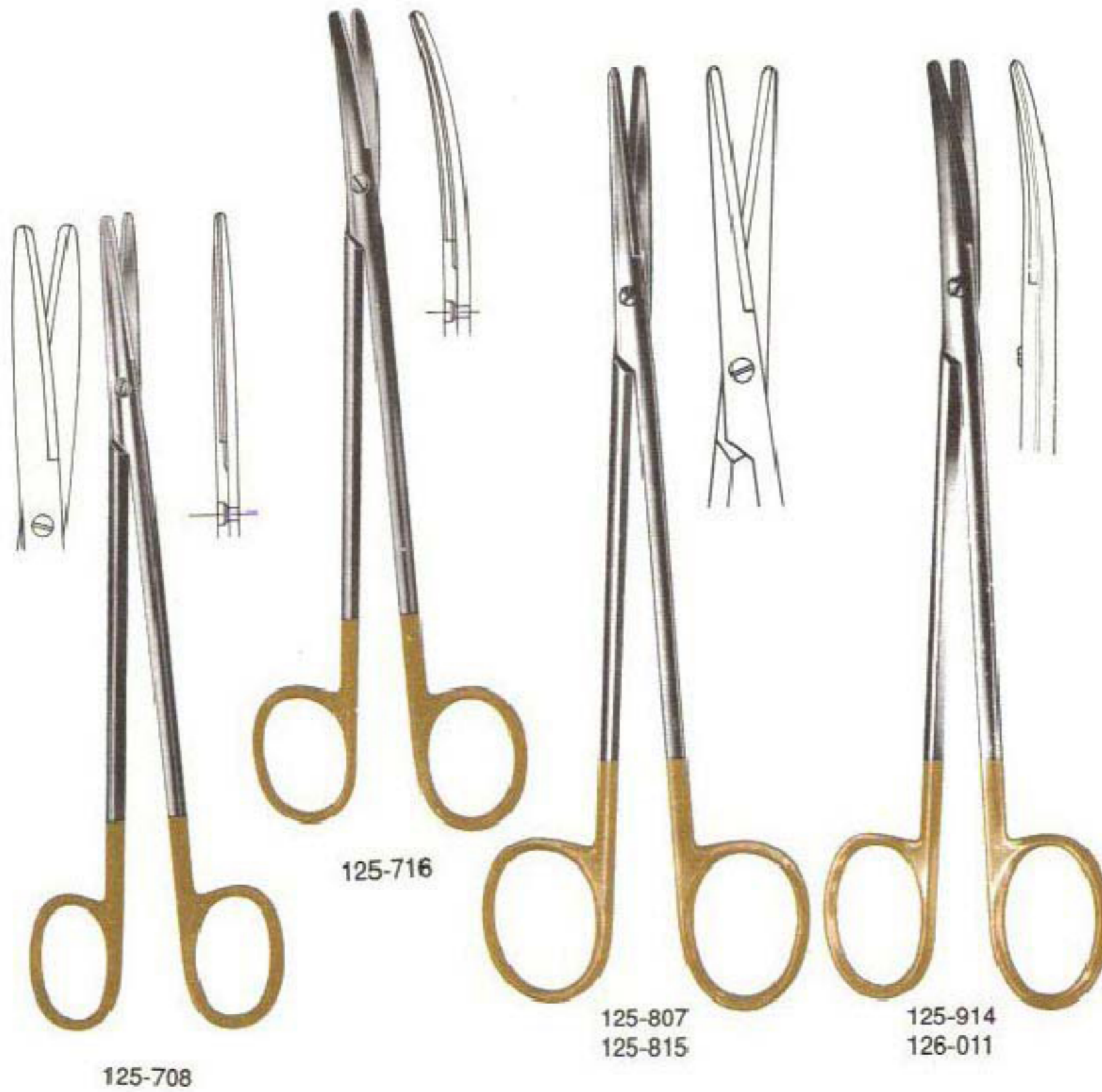

## OPERATING SCISSORS WITH TUNGSTEN CARBIDE BLADES

125-708	METZENBAUM Scissors, 7" (17.8 cm), Straight, TC-blades
125-716	METZENBAUM Scissors, 7" (17.8 cm), Curved, TC-blades
125-807	METZENBAUM Scissors, 8" (20.3 cm), Straight, TC-blades
125-815	METZENBAUM Scissors, 8" (20.3 cm), Curved, TC-blades
125-912	METZENBAUM Scissors, 9" (22.9 cm), Straight, TC-blades
125-914	METZENBAUM Scissors, 9" (22.9 cm), Curved, TC-blades
125-916	METZENBAUM Scissors, 10" (25.4 cm), Curved, TC-blades
126-011	METZENBAUM Scissors, 11" (27.9 cm), Curved, TC-blades
126-014	METZENBAUM Scissors, 12" (30.5 cm), Curved, TC-blades



## OPERATING SCISSORS WITH TUNGSTEN CARBIDE BLADES

- |         |   |
|---------|---|
| 126-557 | MAYO Dissecting Scissors, 5-1/2" (14 cm), straight,<br>Standard Beveled Blades, TC-blades   |
| 126-565 | MAYO Dissecting Scissors, 5-1/2" (14 cm), curved,<br>Standard Beveled Blades, TC-blades     |
| 126-673 | MAYO Dissecting Scissors, 6-3/4" (17.1 cm), curved,<br>Standard Beveled Blades, TC-blades   |
| 126-755 | MAYO Dissecting Scissors, 6-3/4" (17.1 cm), straight,<br>Standard Beveled Blades, TC-blades |



# TUNGSTEN CARBIDE



- 126-855 MAYO Dissecting Scissors, 5-1/2" (14 cm), straight, rounded blades, TC-blades
- 126-860 MAYO Dissecting Scissors, 5-1/2" (14 cm), curved, rounded blades, TC-blades
- 126-865 MAYO Dissecting Scissors, 6-3/4" (17.1 cm), straight, rounded blades, TC-blades
- 126-870 MAYO Dissecting Scissors, 6-3/4" (17.1 cm), curved, rounded blades, TC-blades
- 129-009 MAYO Dissecting Scissors, 9" (22.9 cm), straight, standard beveled blades, TC-blades
- 129-017 MAYO Dissecting Scissors, 9" (22.9 cm), curved, standard beveled blades, TC-blades
- 129-020 GOLDMAN-FOX Scissors, curved fine tips, one serrated blade, TC-blades
- 129-030 FOMON Dorsal Scissors, 5-1/2" (14 cm), angular, one blade serrated, TC blades
- 381-715 RÔGER Wire Cutting Scissors, 4-3/4" (12.1 cm), angled to side, one serrated blade, TC-blades



### BANDAGE SCISSORS

A	11-158	Lister Bandage Scissors, 5 1/2", Utility Grade
B	11-159	Lister Bandage Scissors, 7 1/2", Utility Grade
C	160-259	Lister Bandage Scissors, 3 1/2"
D	160-457	Lister Bandage Scissors, 4 1/2"
E	160-556	Lister Bandage Scissors, 5 1/2"
F	160-754	Lister Bandage Scissors, 7 1/4"
G	160-760	Lister Bandage Scissors, 8"
H	160-765	Richter Dissecting Scissors, 5" Angular Blades One Sharp and One Blunt Point



161-000



161-109



161-752  
161-802



161-804  
161-807

### BANDAGE SCISSORS



161-809  
161-811

- 161-000 Knowles Bandage Scissors, 5-1/2"
- 161-109 Bandage and Plaster Shears, Eccentric Joint, Heavy, 7-1/4"
- 161-752 Lister Bandage Scissors, One Large Ring, 7-1/2"
- 161-802 Lister Bandage Scissors, One Large Ring, 8"
- 161-804 Doyen Scissors, Straight, 7"
- 161-807 Doyen Scissors, Curved, 7"
- 161-809 Doyen Scissors, Straight, Serrated Blade, 7"
- 161-811 Doyen Scissors, Curved, Serrated Blade, 7"



D

## PLASTER CAST INSTRUMENTS

- A 182-004 Utility Shears, Coated Handles, 5-1/2"
- 182-006 Utility Shears, Coated Handles, 7-1/2" (Assorted Colors)
- B 182-055 U.S.A. Pattern Gauze Shears, 8"
- 182-105 Plaster Shears, Scalloped Blade, 9-1/4"
- C 182-154 First Aid Shears, Heavy Duty Serrated Blades, 8-1/4"
- D 182-204 Esmarch Plaster Shears, 8"



## PLASTER CAST INSTRUMENTS

- A** 182-253    Bruns Plaster Shears, Serrated, 9 ½"
- B** 182-303    Stille Plaster Shears, For One Hand, 9"
- C** 182-452    Stille Plaster Shears, Serrated, For Two Hands, 15"





### PLASTER CAST INSTRUMENTS

- A** 182-352 Hennig Plaster Spreader, 11", Blades 2" Wide
- B** 182-354 Beeson Cast Spreader, 12", Blades 2" Wide
- C** 182-402 Wolfe-Boehler Cast Breaker, 10"
- D** 182-405 3-Prong Cast Spreader, 9" with Spring Action for One-Handed Operation

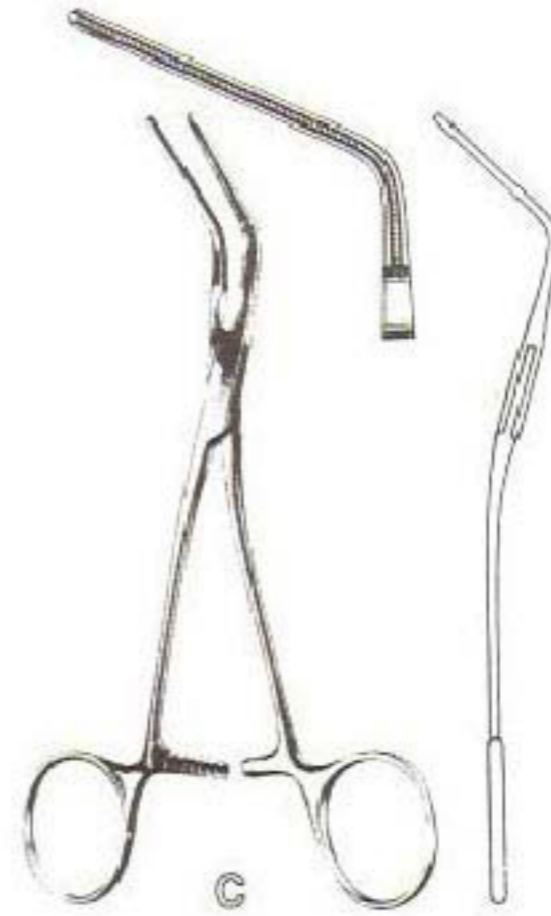
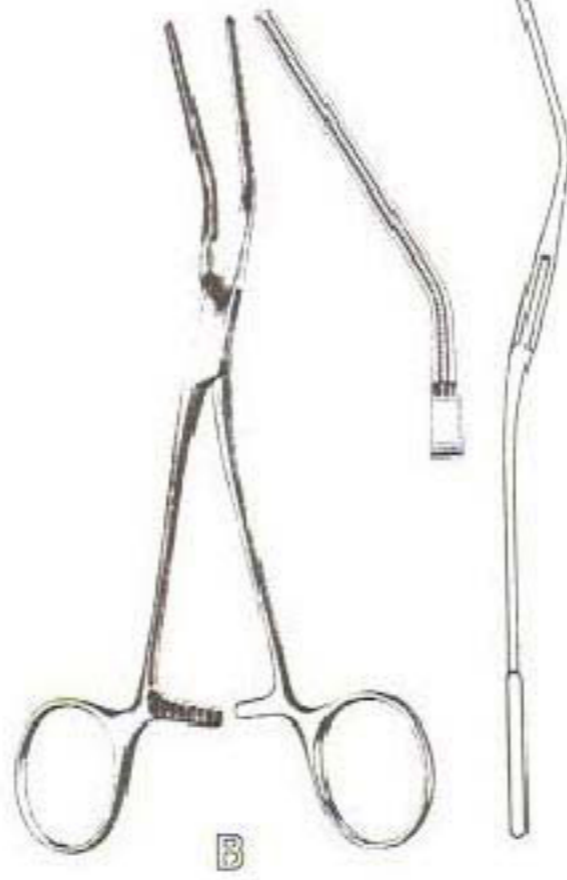

### ATRAUMATIC FORCEPS

- A 640-135 DeBakey Pediatric Multi-Purpose Clamp, 6-1/4", Straight
- B 640-140 DeBakey Pediatric Multi-Purpose Clamp, 6", 30° Angled
- C 640-145 DeBakey Pediatric Multi-Purpose Clamp, 6", 60° Angled
- D 640-150 DeBakey Pediatric Multi-Purpose Clamp, 5-1/2", 90° Angled



200-600  
200-618



200-709  
200-717



200-766

### HEMOSTATIC FORCEPS

200-600 Rankin-Kelly Hemostats, Straight, 6-1/4"

200-618 Rankin-Kelly Hemostats, Curved, 6-1/4"

200-709 Halstead-Mosquito Forceps, 1 x 2 Teeth, Straight, 5"

200-717 Halstead-Mosquito Forceps, 1 x 2 Teeth, Curved, 5"

200-766 Halstead-Mosquito Forceps, Angled Jaw, 5"

200-770 Jacobson Micro Mosquito Forceps, Straight, Extremely Delicate, 5"

200-773 Jacobson Micro Mosquito Forceps, Curved, Extremely Delicate, 5"

200-775 Jacobson Micro Mosquito Forceps, Curved, Extremely Delicate, 7"

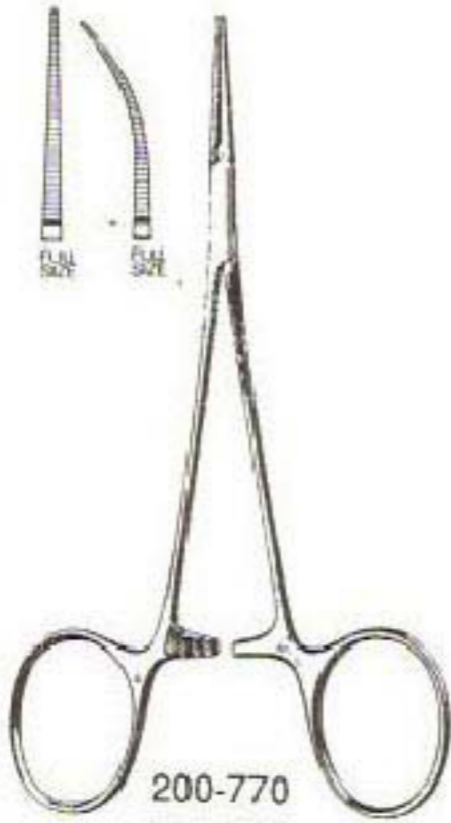

200-770  
200-773



200-775



200-808  
200-816



200-907  
200-915



200-956  
200-964

## HEMOSTATIC FORCEPS

- |         |   |
|---------|---|
| 200-808 | Providence Hospital Forceps, Straight, 5-1/2" |
| 200-816 | Providence Hospital Forceps, Curved, 5-1/2"   |
| 200-907 | Crile Hemostats, Straight, 5-1/2"             |
| 200-915 | Crile Hemostats, Curved, 5-1/2"               |
| 200-956 | Rankin-Crile Hemostats, Straight, 6-1/4"      |
| 200-964 | Rankin-Crile Hemostats, Curved, 6-1/4"        |

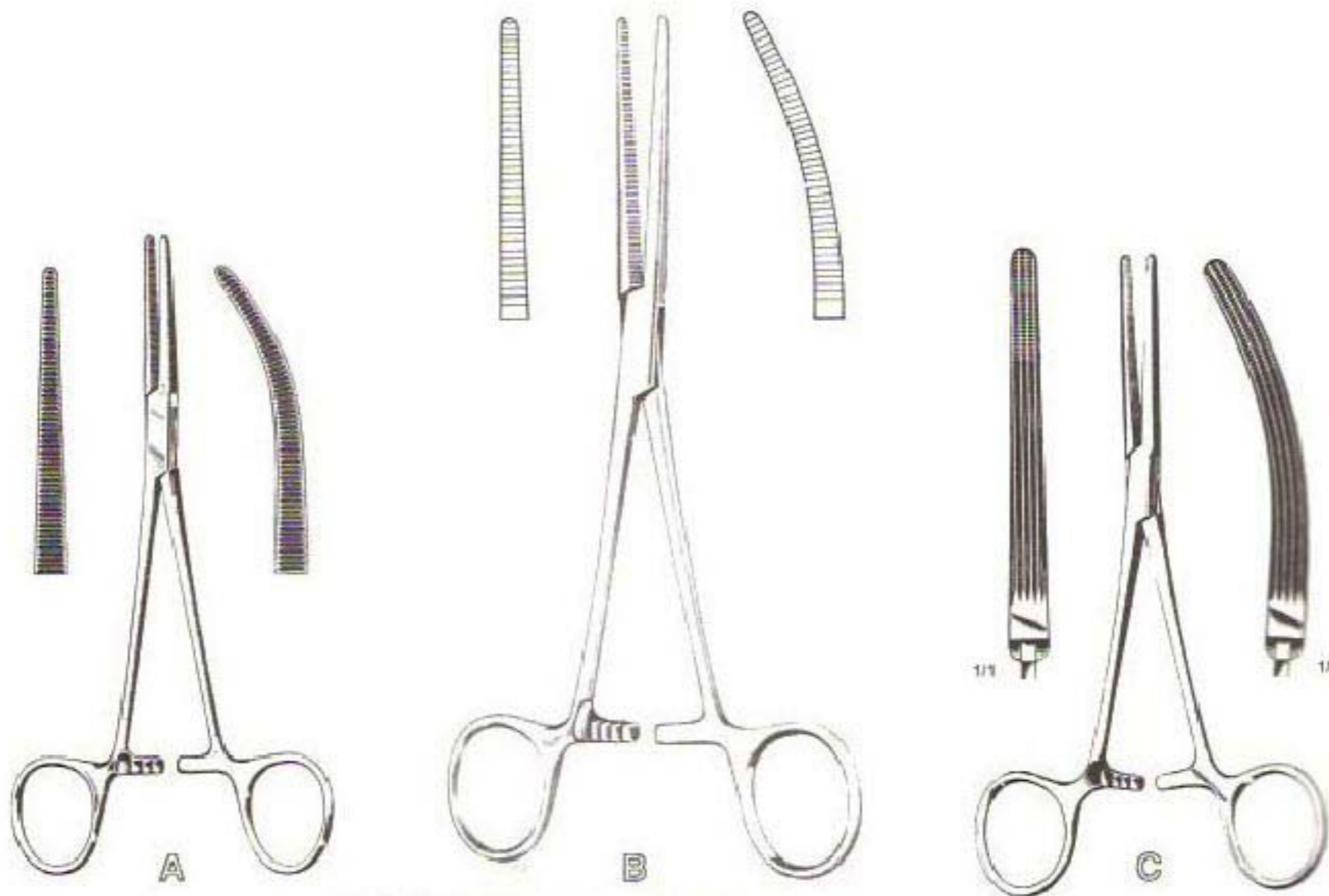

## HEMOSTATIC FORCEPS

A	201-558	Rochester-Pean Hemostats, Straight, 5-1/2"
	201-566	Rochester-Pean Hemostats, Curved, 5-1/2"
B	201-657	Rochester-Pean Hemostats, Straight, 6-1/4"
	201-665	Rochester-Pean Hemostats, Curved, 6-1/4"
	201-756	Rochester-Pean Hemostats, Straight, 7-1/4"
	201-764	Rochester-Pean Hemostats, Curved, 7-1/4"
	201-806	Rochester-Pean Hemostats, Straight, 8"
	201-814	Rochester-Pean Hemostats, Curved, 8"
201-905	201-913	Rochester-Pean Hemostats, Straight, 9"
	201-913	Rochester-Pean Hemostats, Curved, 9"
202-002	202-010	Rochester-Pean Hemostats, Straight, 10-1/4"
	202-010	Rochester-Pean Hemostats, Curved, 10-1/4"
202-012	202-014	Rochester-Pean Hemostats, Straight, 12"
	202-014	Rochester-Pean Hemostats, Curved, 12"
C	202-200	Rochester-Carmalt Hemostats, Straight, 6-1/4"
	202-218	Rochester-Carmalt Hemostats, Curved, 6-1/4"
202-259	202-267	Rochester-Carmalt Hemostats, Straight, 8"
	202-267	Rochester-Carmalt Hemostats, Curved, 8"



## HEMOSTATIC FORCEPS

- A** 202-556 Kocher Hemostats, 1 x 2 Teeth, Straight, 5-1/2"  
202-564 Kocher Hemostats, 1 x 2 Teeth, Curved, 5-1/2"
- B** 202-655 Rochester-Ochsner Hemostats, 1x2 Teeth, Straight, 6 1/4"  
202-705 Rochester-Ochsner Hemostats, 1x2 Teeth, Straight, 7 1/4"  
202-804 Rochester-Ochsner Hemostats, 1x2 Teeth, Straight, 8"  
202-815 Rochester-Ochsner Hemostats, 1x2 Teeth, Straight, 9"  
203-000 Rochester-Ochsner Hemostats, 1x2 Teeth, Straight, 10"
- 202-663 Rochester-Ochsner Hemostats, 1x2 Teeth, Curved, 6 1/4"  
202-713 Rochester-Ochsner Hemostats, 1x2 Teeth, Curved, 7 1/4"  
202-812 Rochester-Ochsner Hemostats, 1x2 Teeth, Curved, 8"  
202-819 Rochester-Ochsner Hemostats, 1x2 Teeth, Curved, 9"  
203-018 Rochester-Ochsner Hemostats, 1x2 Teeth, Curved, 10"



### HEMOSTATIC FORCEPS



D

- A 203-158 Pennington Forceps, 6"
- B 203-208 Pratt-Smith "T" Forceps, 6"
- C 203-307 Bainbridge Forceps, Straight, 7-1/4"  
203-315 Bainbridge Forceps, Curved, 7-1/4"
- D 203-406 Dieffenbach Serrefines, Straight, 1-1/2"  
E 203-414 Dieffenbach Serrefines, Curved, 1-1/2"
- D 203-455 Dieffenbach Serrefines, Straight, 2-1/4"  
E 203-463 Dieffenbach Serrefines, Curved, 2-1/4"



E



### HEMOSTATIC FORCEPS

- 221-960 MOYNIHAN Gall Duct Forceps, 8-1/2" (21.6 cm)
- 221-962 JOHN HOPKINS Gall Bladder Forceps, 8" (20.3 cm)
- 221-964 GREEN Cystic Duct Forceps, 8-1/2" (21.6 cm), delicate
- 221-966 GRAY Cystic Duct Forceps, 9" (22.9 cm), Serrated, set of 2
- 221-967 GRAY Cystic Duct Forceps, 9" (22.9 cm), Serrated 1x2 teeth set of 2
- 221-968 BRIDGE Deep Surgery Forceps, 11" (27.9 cm), Straight, very delicate
- 221-970 BRIDGE Deep Surgery Forceps, 11" (27.9 cm), Curved, very delicate







## HEMOSTATIC FORCEPS

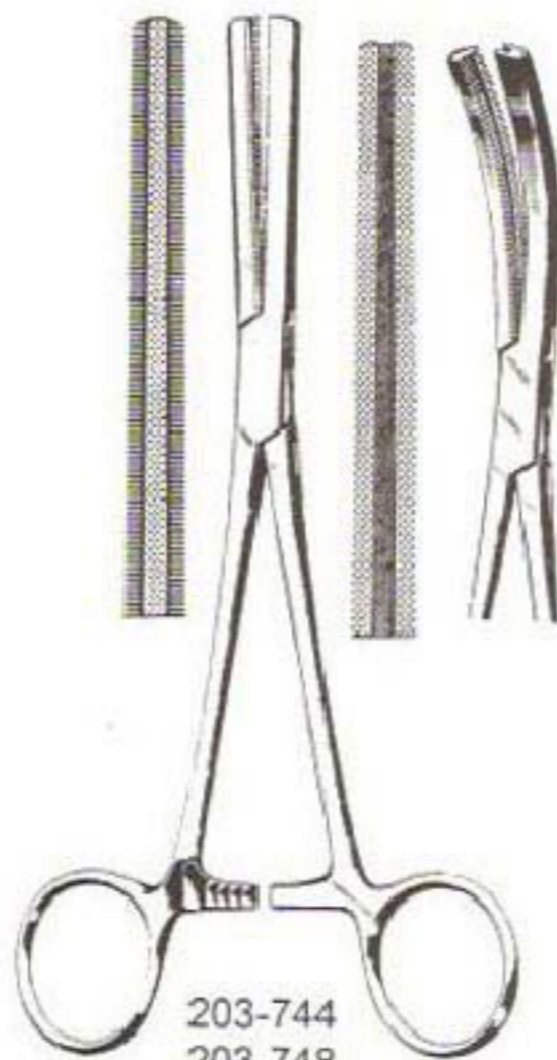

203-744  
203-748  
203-752  
203-760



923-805  
923-813

- |         |   |
|---------|---|
| 203-744 | Ferguson Angiotribe Forceps, Straight, 6 1/2"                                 |
| 203-748 | Ferguson Angiotribe Forceps, Curved, 6 1/2"                                   |
| 203-752 | Ferguson Angiotribe Forceps, Straight, 7 1/2"                                 |
| 203-760 | Ferguson Angiotribe Forceps, Curved, 7 1/2"                                   |
| 923-805 | Jacobs Vulsellum Forceps, Straight, Serrated Jaws<br>2x2 Teeth, 8 1/2"        |
| 923-813 | Jacobs Vulsellum Forceps, Curved Sideways, Serrated Jaws<br>2x2 Teeth, 8 1/2" |



## HEMOSTATIC FORCEPS

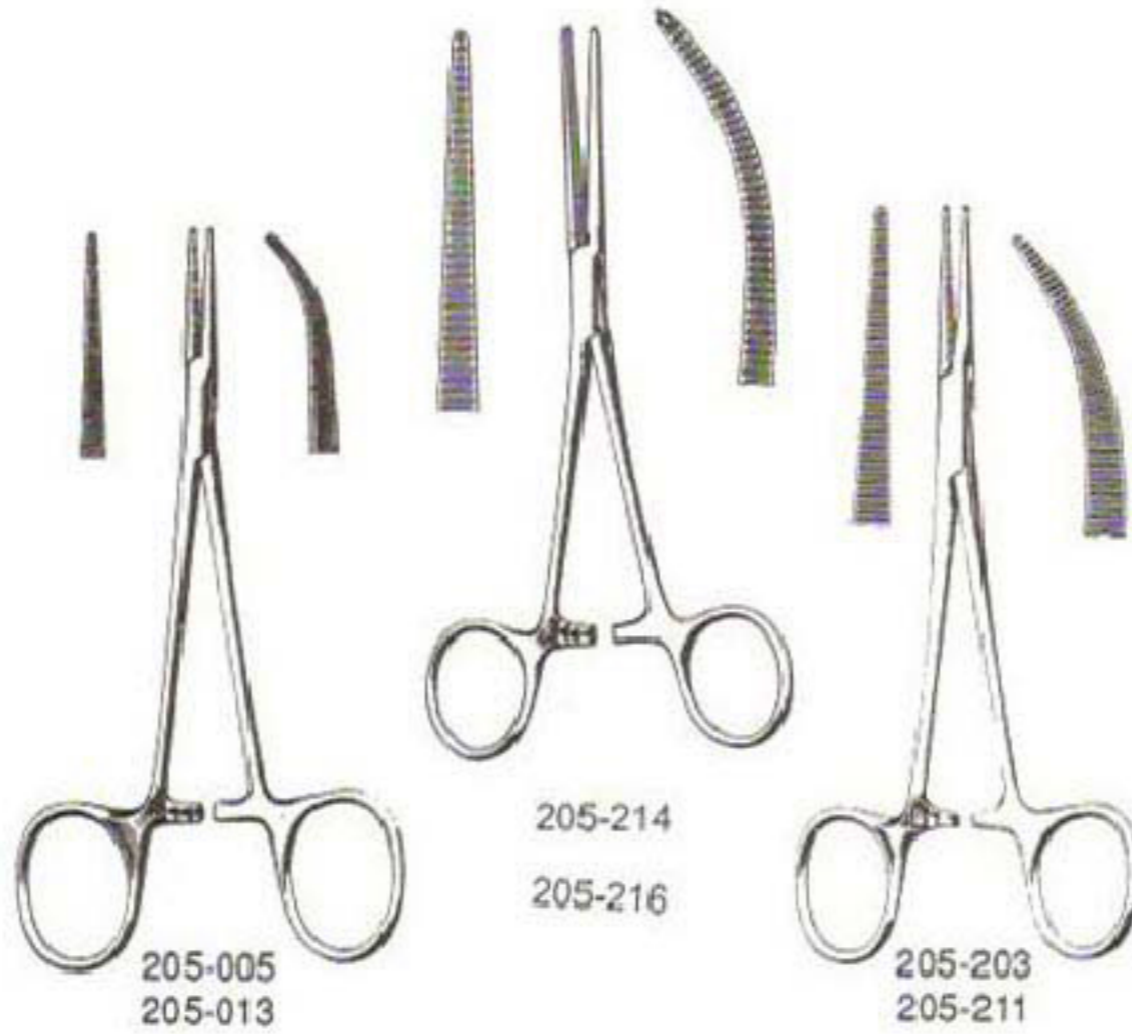

205-005 HALSTEAD Mosquito Forceps, Extra fine, straight, pediatric, 4-3/4" (12 cm)  
205-013 HALSTEAD Mosquito Forceps, Extra fine, curved, pediatric, 4-3/4" (12 cm)

205-203 Baby CRILE Forceps, 5-1/2" (14 cm), extra delicate, straight  
205-211 Baby CRILE Forceps, 5-1/2" (14 cm), extra delicate, curved

205-214 Baby OCHSNER Forceps 1 X 2 teeth, 5-1/2" (14 cm), extra delicate, straight  
205-216 Baby OCHSNER Forceps 1 X 2 teeth, 5-1/2" (14 cm), extra delicate, curved

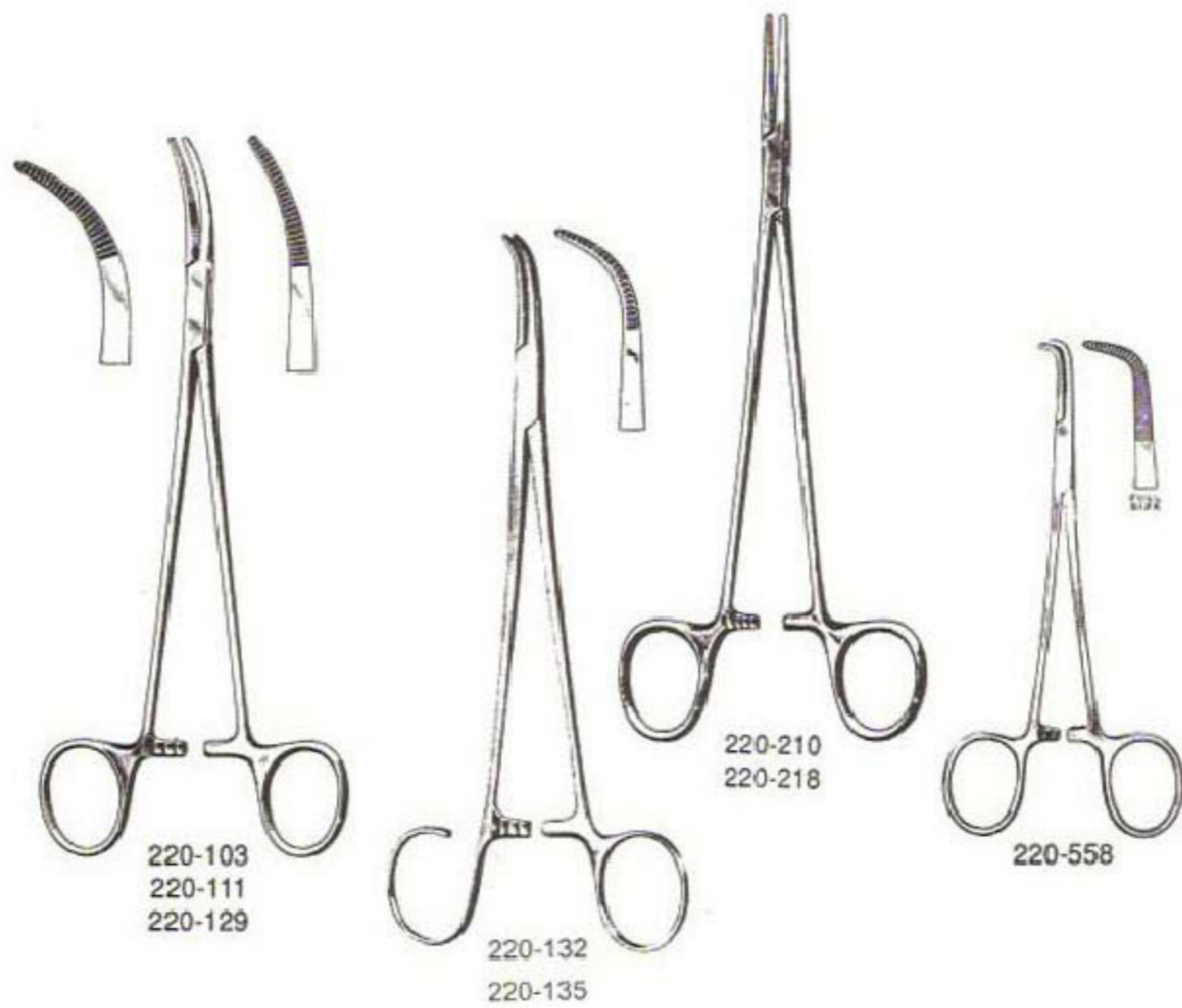

### HEMOSTATIC FORCEPS

- 220-103 SCHNIDT Hemostatic Forcep, Straight, 7-1/2" (19.1 cm)
- 220-111 SCHNIDT Hemostatic Forcep, slight curve, 7-1/2" (19.1 cm)
- 220-129 SCHNIDT Hemostatic Forcep, full curve, 7-1/2" (19.1 cm)
- 220-132 SAWTELL Tonsil Hemostat Forceps, 7-1/2" (19.1 cm), full curve, one open ring
- 220-135 SAWTELL Tonsil Hemostat Forceps, 7-1/2" (19.1 cm), full curve, closed rings
- 220-210 Mosquito Forceps, extra delicate, straight, 7-1/2" (19.1 cm)
- 220-218 Mosquito Forceps, extra delicate, curved, 7-1/2" (19.1 cm)
- 220-558 Baby MIXTER Forceps, 5-1/4" (13.3 cm), fully curved, extra delicate



220-655  
220-705

220-756  
220-760  
220-780

221-259  
221-267

### HEMOSTATIC FORCEPS

- 220-655 Mixer Forceps, Original Model, Right Angled, 6-1/4"
- 220-705 Mixer Forceps, Original Model, Right Angled, 7-1/4"
- 220-756 Mixer Forceps, Fine Dissecting Points, Fully Curved, 7-1/2"
- 220-760 Mixer Forceps, Fine Dissecting Points, Fully Curved, 9-1/4"
- 220-780 Mixer Forceps, Fine Dissecting Points, Fully Curved, 11"
  
- 221-259 Adson Hemostats, Straight, 7"
- 221-267 Adson Hemostats, Curved, 7"



221-309  
221-317  
221-325

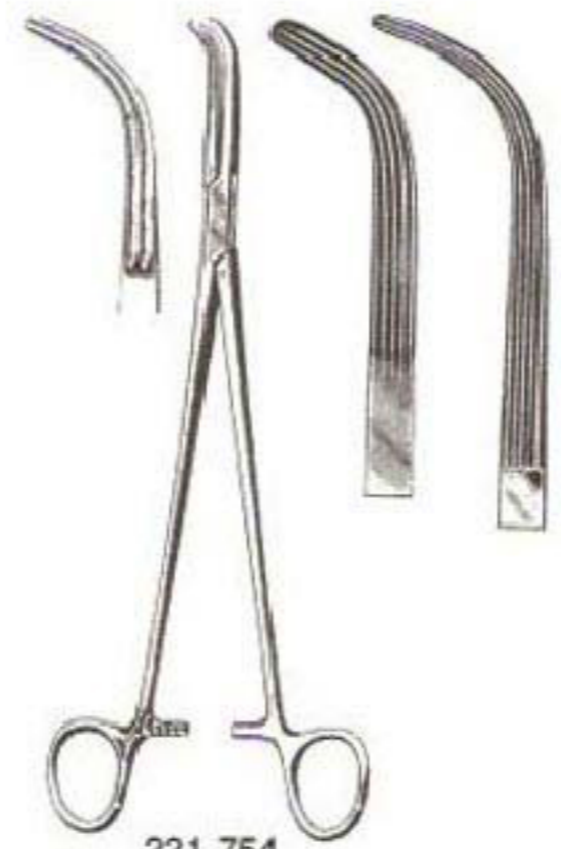

221-754  
221-952  
222-000

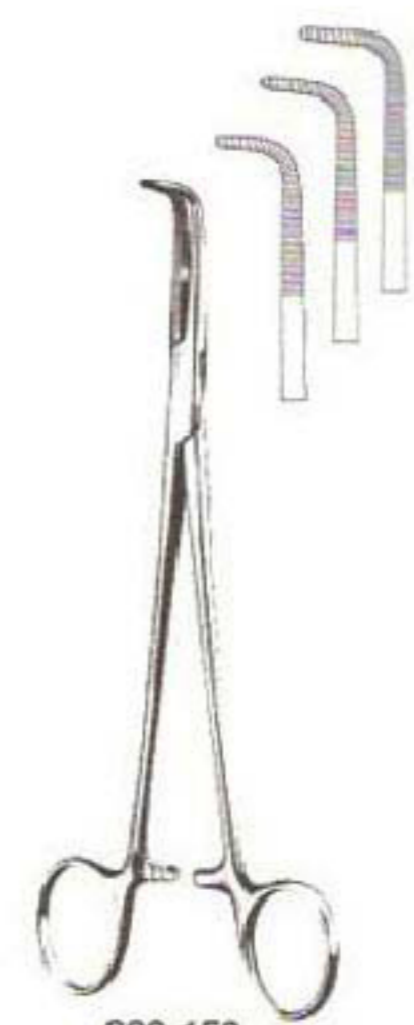

222-158  
222-208  
222-210

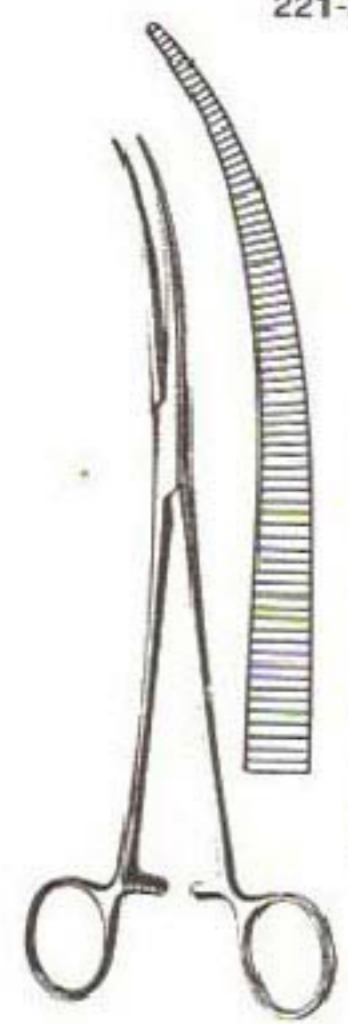

222-215

### HEMOSTATIC FORCEPS

- 221-309 Heiss Thoracic Forceps, Straight, 8"
- 221-317 Heiss Thoracic Forceps, Slightly Curved, 8"
- 221-325 Heiss Thoracic Forceps, Full Curved, 8"
- 221-754 Lahey Hemostatic Forceps, 7 1/2"
- 221-952 Lahey Hemostatic Forceps, 9"
- 222-000 Lahey Hemostatic Forceps, 11"
- 222-158 Kantrowitz Forceps, 7 1/2", Delicate Right Angle Jaws
- 222-208 Kantrowitz Forceps, 9 1/2", Delicate Right Angle Jaws
- 222-210 Kantrowitz Forceps, 11", Delicate Right Angle Jaws
- 222-215 Sarot Artery Forceps, 9 1/2", with 2 1/2" Long Jaws



## HEMOSTATIC FORCEPS



A

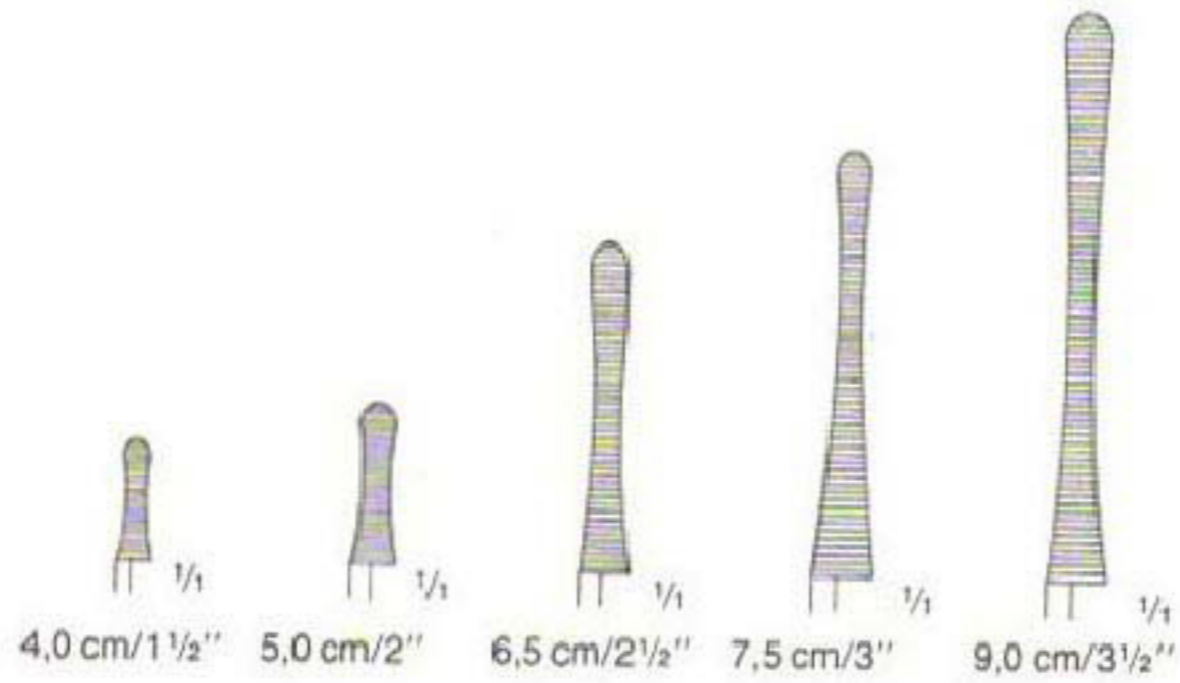

A	645-475	Johns-Hopkins Bulldog Clamp, Straight, 1 1/2"
	645-480	Johns-Hopkins Bulldog Clamp, Straight, 2"
	645-485	Johns-Hopkins Bulldog Clamp, Straight, 2 1/2"
	645-490	Johns-Hopkins Bulldog Clamp, Straight, 3"
	645-495	Johns-Hopkins Bulldog Clamp, Straight, 3 1/2"



B

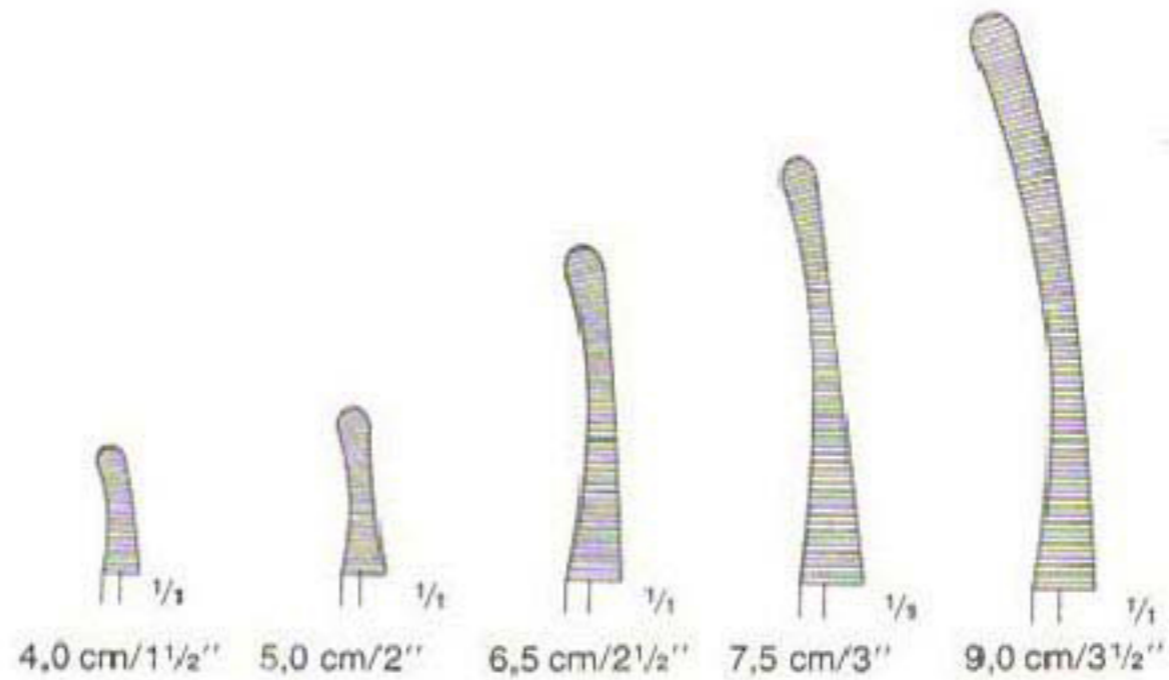

B	645-507	Johns-Hopkins Bulldog Clamp, Curved, 1 1/2"
	645-515	Johns-Hopkins Bulldog Clamp, Curved, 2"
	645-531	Johns-Hopkins Bulldog Clamp, Curved, 2 1/2"
	645-556	Johns-Hopkins Bulldog Clamp, Curved, 3"
	645-564	Johns-Hopkins Bulldog Clamp, Curved, 3 1/2"



## HEMOSTATIC FORCEPS

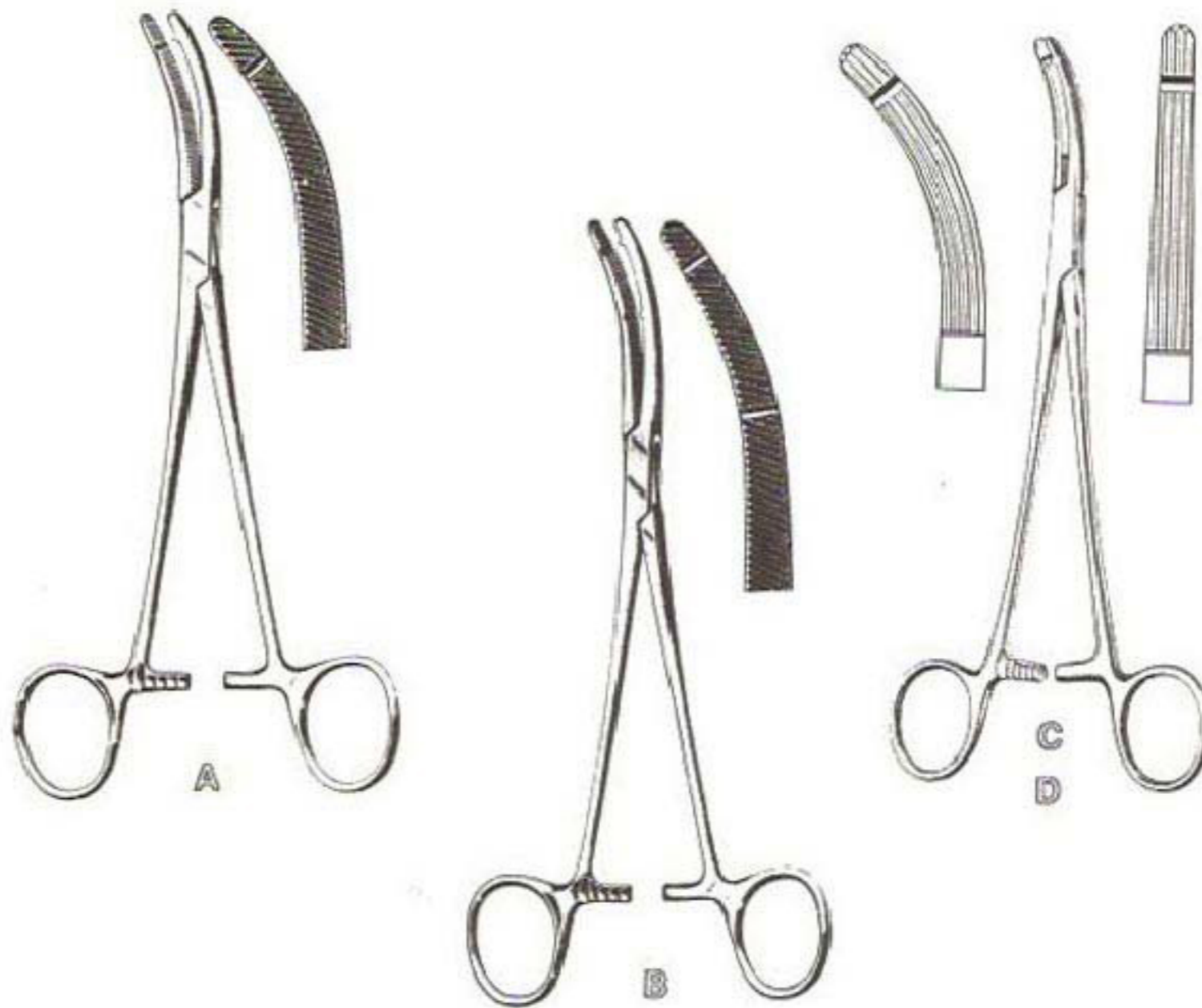

- A** 925-602 Heaney Hysterectomy Forceps, 8-1/4", Heavy Pattern, Single Tooth, Curved
- B** 925-651 Heaney Hysterectomy Forceps, 8-1/4", Heavy Pattern, Double Tooth, Curved
- 925-652 Heaney Hysterectomy Forceps, 9-3/4" Extra Heavy Pattern, Double Tooth, Curved
- C** 925-676 Heaney-Ballentine Hysterectomy Forceps, 8-1/2", longitudinal serrations, single tooth, straight
- D** 925-701 Heaney-Ballentine Hysterectomy Forceps, 8-1/4", longitudinal serrations, single tooth, curved



## HEMOSTATIC FORCEPS



- |   |         |  |
|---|---------|--|
| A | 925-552 | Long Hysterectomy Forceps, 7 1/2"<br>Longitudinal Serrations, 1x2 Teeth, Curved    |
| B | 925-800 | Phaneuf Uterine Forceps, 8" Horizontal Serrated Jaws<br>1x2 Teeth, Straight        |
|   | 925-818 | Phaneuf Uterine Forceps, 8", Horizontal Serrated Jaws<br>1x2 Teeth, Angled on Flat |
| C | 925-822 | Wertheim Pedicle Clamp, 9 1/4", Curved Jaws 2" Long                                |
| D | 925-825 | Wertheim-Cullen Pedicle Clamp, 8 1/2"<br>Right Angle Jaws, 2" Long                 |





### SPONGE FORCEPS

- |          |         |   |
|----------|---------|---|
| <b>A</b> | 240-754 | Ballenger Sponge Forceps, Straight, Serrated, 7"    |
| <b>B</b> | 240-762 | Ballenger Sponge Forceps, Curved, Serrated, 7"      |
| <b>A</b> | 240-770 | Ballenger Sponge Forceps, Straight, Smooth, 7"      |
| <b>B</b> | 240-788 | Ballenger Sponge Forceps, Curved, Smooth, 7"        |
| <b>A</b> | 240-952 | Foerster Sponge Forceps, Straight, Serrated, 9-1/2" |
| <b>B</b> | 240-960 | Foerster Sponge Forceps, Curved, Serrated, 9-1/2"   |
| <b>A</b> | 240-978 | Foerster Sponge Forceps, Straight, Smooth, 9-1/2"   |
| <b>B</b> | 240-986 | Foerster Sponge Forceps, Curved, Smooth, 9-1/2"     |
| <b>C</b> | 241-109 | Bauer Sponge Forceps, 9-1/2"                        |



241-356



241-554



241-604

### TOWEL CLAMPS

- 241-356 Backhaus Towel Clamps, 3 1/4"
- 241-554 Backhaus Towel Clamps, 5 1/4"
- 241-604 Backhaus-Roeder Towel Clamps, 5 1/4"
- 241-606 Ball and Socket Towel Clamps, 5 1/4"

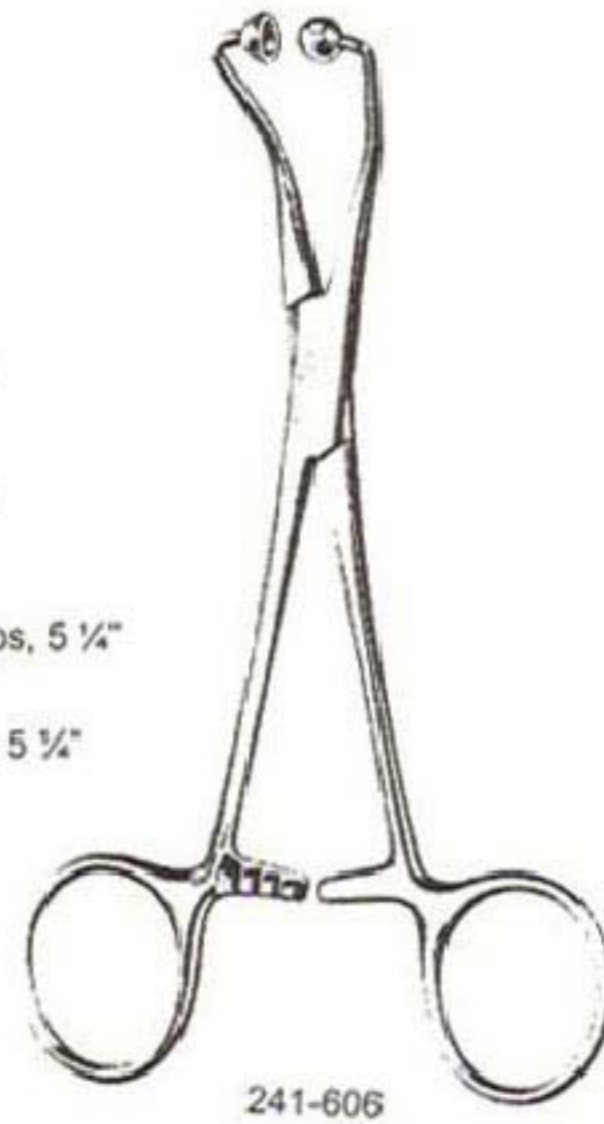

241-606

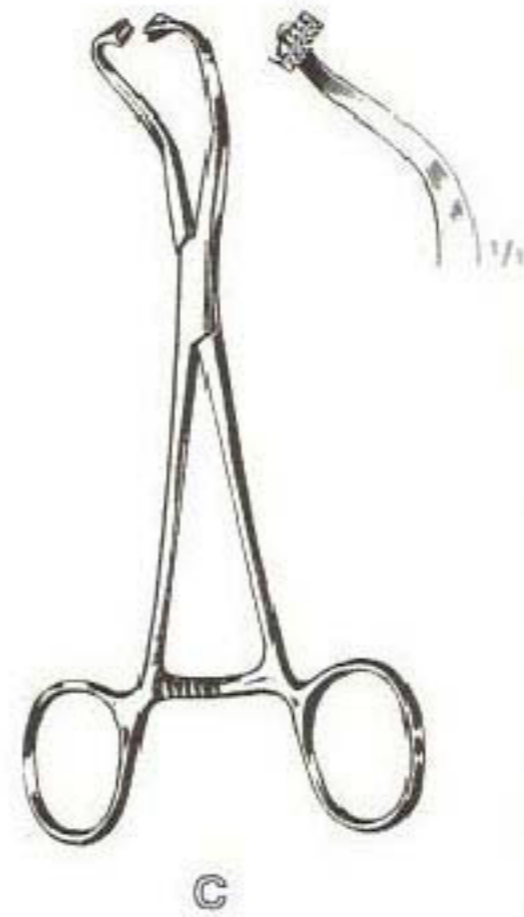

### TOWEL CLAMPS

- A** 241-620 Jones Towel Clamps, "Baby", 2-1/2"  
241-638 Jones Towel Clamps, 3"
- B** 241-654 Lorna Towel Clamps, 4"  
241-656 Lorna Towel Clamps, 5-1/4"
- C** 241-657 Peers Towel Clamps, 5-3/4"



260-059



260-166  
260-208

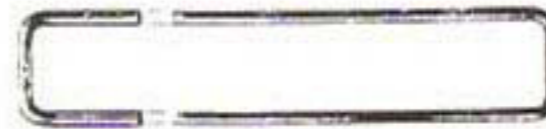

260-210  
260-212



260-213



260-236

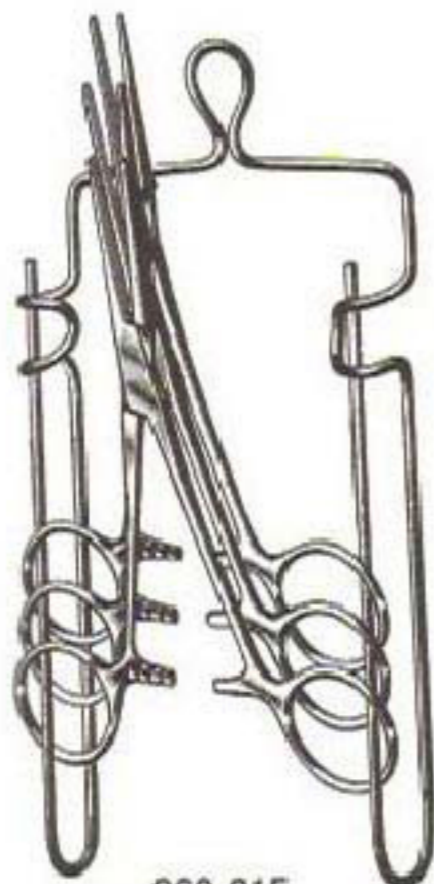

260-215

## INSTRUMENT RACKS

- 260-059 BUNT Forceps Holder 4-3/4"
- 260-166 Instrument Holders (stringers), 6", "T" Bar (15.2 cm)
- 260-208 Instrument Holders (stringers), 12", "T" Bar (30.5 cm)
- 260-210 WEINSTEIN Instrument Sterilizing Rack, Small, 5-1/2" X 3"
- 260-212 WEINSTEIN Instrument Sterilizing Rack, Large, 11-1/4" X 3"
- 260-213 CROWN Instrument Sterilizing Rack
- 260-215 Saunders Instrument Sterilizing Rack
- 260-236 Mesh Holder 6-3/4", 2-1/8" Inside Diameter of Basket  
securely holds small items such as micro clips, screws,  
Burs, etc. during cleaning, rinsing or sterilization

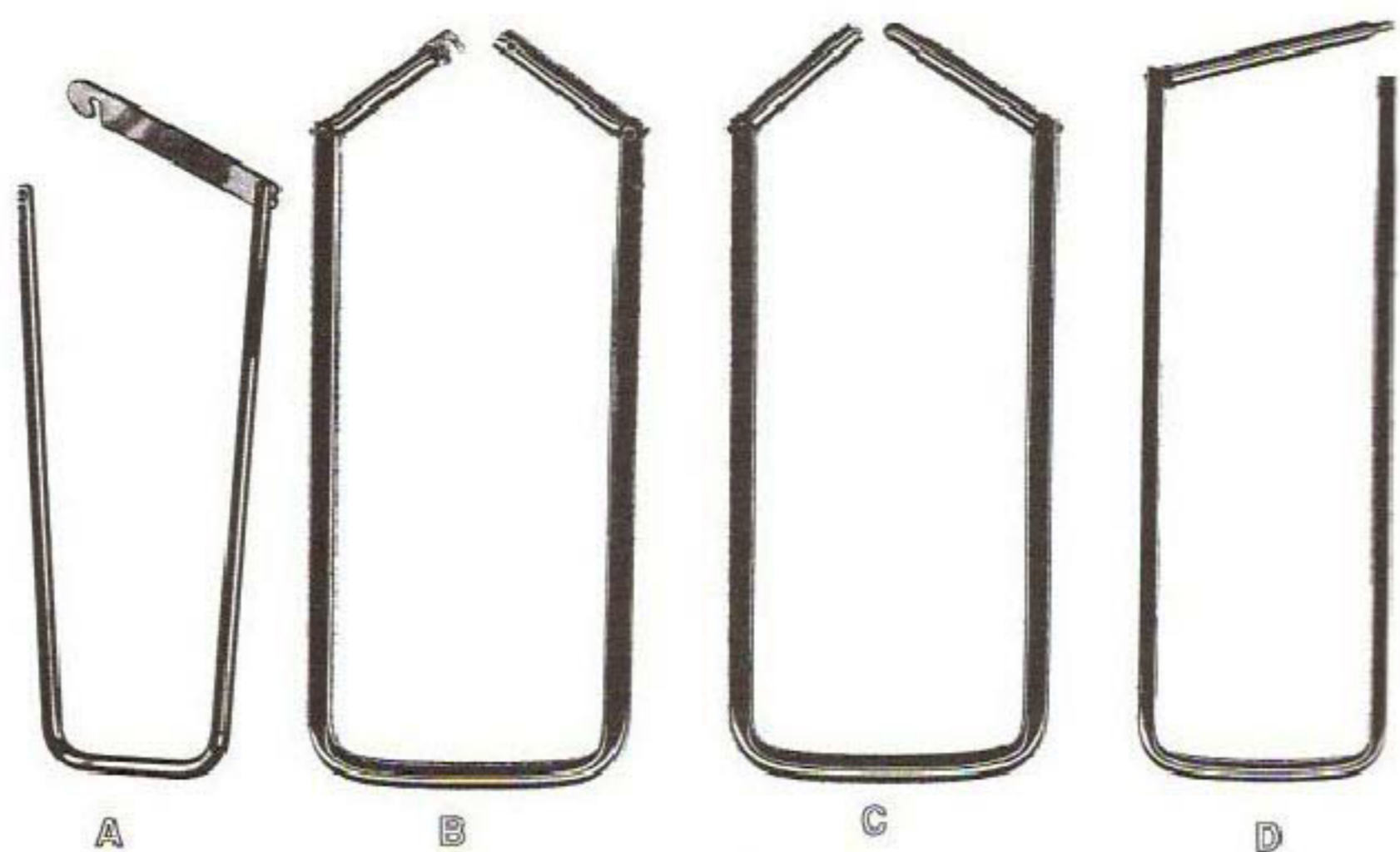

### INSTRUMENT STRINGERS

A	260-222	HOOK-LOK Instrument Stringer 2-1/2" wide, Length 6"
	260-224	HOOK-LOK Instrument Stringer 2-1/2" wide, Length 8"
	260-226	HOOK-LOK Instrument Stringer 2-1/2" wide, Length 10"
	260-228	HOOK-LOK Instrument Stringer 2-1/2" wide, Length 12"
	260-230	HOOK-LOK Instrument Stringer 2-1/2" wide, Length 14"
	260-232	HOOK-LOK Instrument Stringer 2-1/2" wide, Length 16"
	260-234	HOOK-LOK Instrument Stringer 2-1/2" wide, Length 18"
B	260-238	CENTER-LOK Instrument Stringer 2-1/2" wide, Length 6"
	260-240	CENTER-LOK Instrument Stringer 2-1/2" wide, Length 8"
	260-242	CENTER-LOK Instrument Stringer 2-1/2" wide, Length 10"
	260-244	CENTER-LOK Instrument Stringer 2-1/2" wide, Length 12"
	260-246	CENTER-LOK Instrument Stringer 2-1/2" wide, Length 14"
	260-248	CENTER-LOK Instrument Stringer 2-1/2" wide, Length 16"
	260-250	CENTER-LOK Instrument Stringer 2-1/2" wide, Length 18"
C	260-252	NTRA-LOK Instrument Stringer 2-1/2" wide, Length 6"
	260-254	NTRA-LOK Instrument Stringer 2-1/2" wide, Length 8"
	260-256	NTRA-LOK Instrument Stringer 2-1/2" wide, Length 10"
	260-258	NTRA-LOK Instrument Stringer 2-1/2" wide, Length 12"
	260-260	NTRA-LOK Instrument Stringer 2-1/2" wide, Length 14"
	260-262	NTRA-LOK Instrument Stringer 2-1/2" wide, Length 16"
	260-264	NTRA-LOK Instrument Stringer 2-1/2" wide, Length 18"
D	260-266	PIN-LOK Instrument Stringer 2-1/2" wide, Length 6"
	260-268	PIN-LOK Instrument Stringer 2-1/2" wide, Length 8"
	260-270	PIN-LOK Instrument Stringer 2-1/2" wide, Length 10"
	260-272	PIN-LOK Instrument Stringer 2-1/2" wide, Length 12"
	260-274	PIN-LOK Instrument Stringer 2-1/2" wide, Length 14"
	260-276	PIN-LOK Instrument Stringer 2-1/2" wide, Length 16"
	260-278	PIN-LOK Instrument Stringer 2-1/2" wide, Length 18"



## STERILIZING AIDS

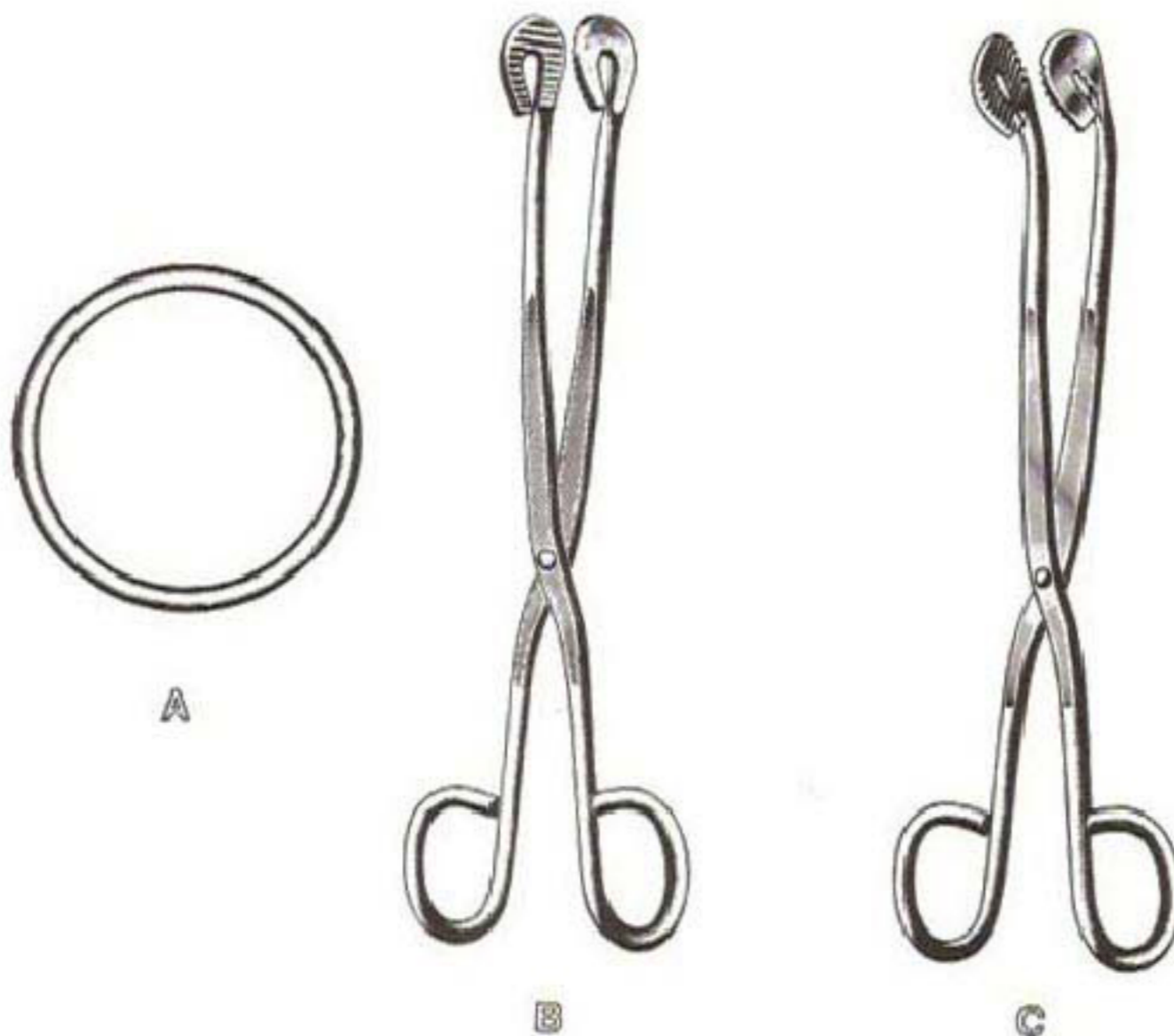

### STERILIZER FORCEPS

- |          |         |  |
|----------|---------|--|
| <b>A</b> | 260-307 | Laparotomy Rings, 1" (2.5 cm)                            |
|          | 260-315 | Laparotomy Rings, 1-1/4" (3.1 cm)                        |
|          | 260-323 | Laparotomy Rings, 1-1/2" (3.8 cm)                        |
|          | 260-331 | Laparotomy Rings, 1-3/4" (4.4 cm)                        |
|          | 260-349 | Laparotomy Rings, 2" (5.1 cm)                            |
|          | 260-356 | Laparotomy Rings, 2-1/4" (5.72 cm)                       |
|          | 260-364 | Laparotomy Rings, 2-1/2" (6.4 cm)                        |
| <b>B</b> | 260-802 | Utility and Sterilizer Forceps, Straight, 8" ( 20.3 cm)  |
|          | 261-107 | Utility and Sterilizer Forceps, Straight, 11" ( 27.9 cm) |
| <b>C</b> | 260-810 | Utility and Sterilizer Forceps, Curved, 8" ( 20.3 cm)    |
|          | 261-115 | Utility and Sterilizer Forceps, Curved, 11" ( 27.9 cm)   |
|          | 260-220 | CHEATLE Sterilizer Forceps, 11" ( 27.9 cm)               |



Cheatle

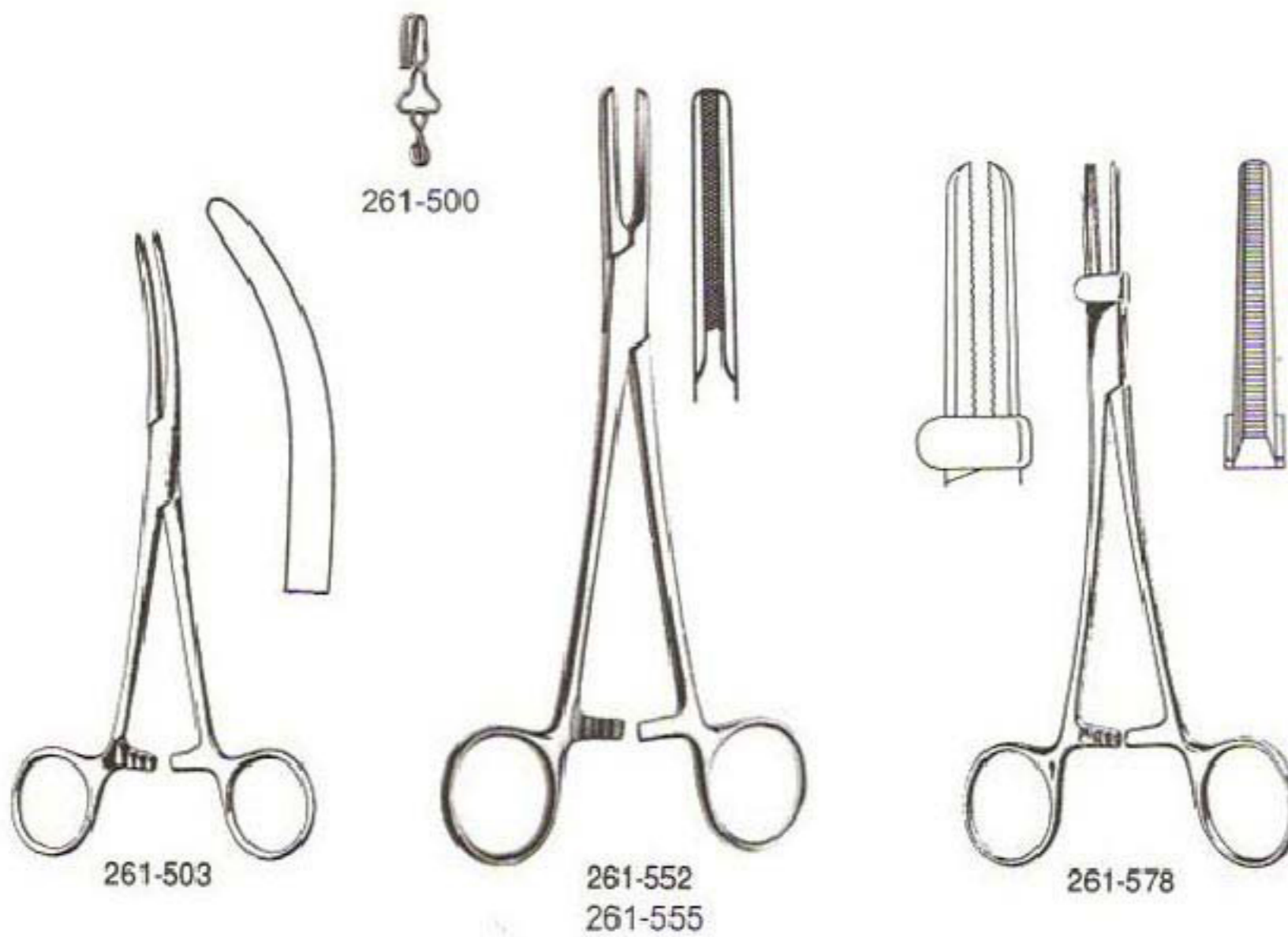

### TUBING CLAMPS

- 261-500 Occlusion Clamp For Arteriovenous Cannula, 1 3/4" Cross Action
- 261-503 St. Vincent's Occluding Forceps, Curved, 6 1/2"
- 261-552 Vorse Occluding Forceps, 6 1/4", Serrated
- 261-555 Vorse Occluding Forceps, 7 1/4", Serrated
- 261-578 Vorse Occluding Forceps, with Guard, 7 1/2"
- 262-253 Presbyterian Occluding Forceps, Smooth Jaws, 6 1/2"
- 262-303 Presbyterian Occluding Forceps, Smooth Jaws, 7 1/4"



### NEEDLE HOLDERS - STANDARD JAW



- A 320-051 Derf Needle Holders, 4-1/2"
- B 320-101 Webster (Halsey) Needle Holders, Smooth Jaws, 4-3/4"
- C 320-103 Halsey Needle Holders, Smooth Jaws, 5"
- D 320-105 Halsey Needle Holders, Serrated Jaws, 5"
- E 320-150 Collier Needle Holders, 5"
- F 320-200 Baumgartner Needle Holders, 5-1/2"
- G 320-259 Abbey Needle Holders, 5"





### NEEDLE HOLDERS – STANDARD JAWS

- A** 320-366 Crile-Wood Needle Holder 6" (15.2 cm)
- 320-368 Crile-Wood Needle Holder 7" (17.8 cm)
- 320-370 Crile-Wood Needle Holder 8" (20.3 cm)
- 320-375 Crile-Wood Needle Holder 9" (22.9 cm)
  
- B** 320-406 Castroviejo Needle Holder, w/out Lock, Straight Smooth Jaws, 5 1/2" 14 cm)
- 320-408 Castroviejo Needle, w/Lock, Straight Straight, Smooth Jaws, 5 1/2"
  
- C** 320-432 Castroviejo Needle Holder, Pen Type, 5 1/4"
  
- D** 320-448 Mayo Hegar Needle Holder, 5 1/2"
- 320-465 Mayo Hegar Needle Holder, 6" (15.2 cm)
- 320-473 Mayo Hegar Needle Holder, 7" (17.8 cm)
- 320-481 Mayo Hegar Needle Holder, 8" (20.3 cm)
  
- E** 320-485 Finochietto Needle Holders, 10 1/2" (26.7 cm) Angled Jaws



### NEEDLE HOLDERS – STANDARD JAWS

- 320-507 Masson Needle Holders, 10 ¼"
- 320-510 Stratte Needle Holders, 9", Double Curved Jaws and Bent Shank
- 320-540 Olsen-Hegar Needle Holder, Combined with Suture Scissors, 4 ¾" (12.1 cm), Extra Delicate Pattern, Serrated Jaws
- 320-545 Olsen-Hegar Needle Holders, combined with Suture Scissors, 4 ¾" (12.1 cm), Extra Delicate Pattern, Smooth Jaws
- 320-556 Olsen-Hegar Needle Holders, 5 ½"
- 320-655 Olsen-Hegar Needle Holders, 6 ½"
- 320-754 Olsen-Hegar Holder Holders, 7 ¼"
- 320-804 Brown Needle Holders, 6 ¾"
- 320-853 M.G.H. Needle Holders, 6 ½"



320-903



320-960  
320-978



321-000



321-105

## NEEDLE HOLDERS - STANDARD JAWS

- 320-903 NEW ORLEANS Needle Holder, 7" (17.8 cm)
- 320-960 MATHIEU Needle Holder, 6-1/4" (15.9 cm), spring handles
- 320-978 MATHIEU Needle Holder, 7-1/2" (19.1 cm), spring handles
- 321-000 HEANEY Needle Holder, 8-1/2" (21.6 cm), curved jaws
- 321-105 SAROT Needle Holder, 7-1/8" (18.1 cm), light model



# TUNGSTEN CARBIDE

## NEEDLE HOLDERS



Needle Holders with TC-Inserts



## TUNGSTEN CARBIDE



### NEEDLE HOLDERS TUNGSTEN CARBIDE INSERTS



- 340-059 Derf Needle Holders, 4-1/2"
- 340-109 Webster Needle Holders, Smooth Jaws, 4-1/2"
- 340-208 Baumgartner Needle Holders, 5-1/2"
- 340-230 Halsey Needle Holders, Serrated Jaws, 5"
- 340-297 Halsey Needle Holders, Smooth Jaws, 5"



# TUNGSTEN CARBIDE



340-364



340-460  
340-463  
340-471  
340-489



340-400  
340-406  
340-407



340-505

## NEEDLE HOLDERS TUNGSTEN CARBIDE INSERTS

- 340-364 Crile-Wood Needle Holders, 6"
- 340-460 Mayo-Hegar Needle Holders, 5-1/2"
- 340-463 Mayo-Hegar Needle Holders, 6"
- 340-471 Mayo-Hegar Needle Holders, 7"
- 340-489 Mayo-Hegar Needle Holders, 8"
- 340-400 Castroviejo Needle Holders, without Lock, Serrated Jaws, 5-1/4"
- 340-406 Castroviejo Needle Holders, with Lock, Smooth Jaws, 5-1/4"
- 340-407 Castroviejo Needle Holders, with Lock, Serrated Jaws, 5-1/4"
- 340-505 Masson Needle Holders, 10-1/2"



## TUNGSTEN CARBIDE

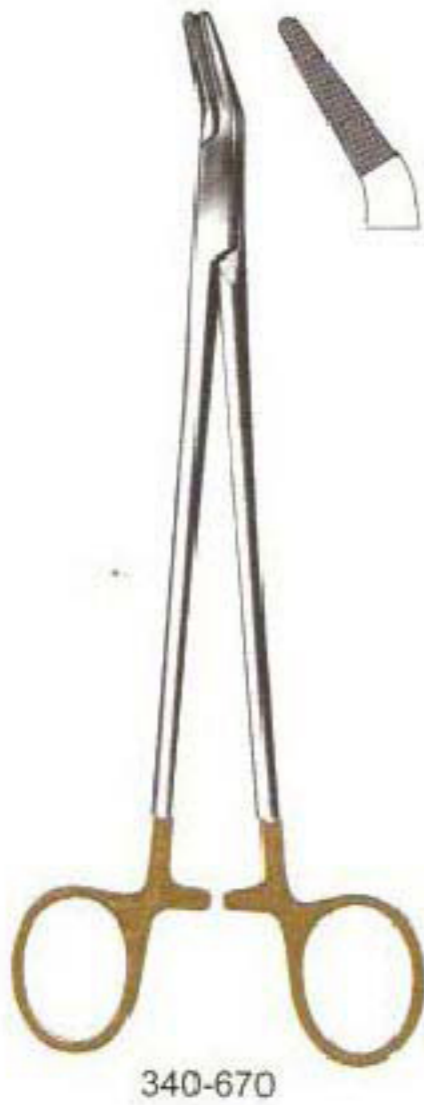

### NEEDLE HOLDERS TUNGSTEN CARBIDE INSERTS

- 340-529 Olsen-Hegar Needle Holders Combined with Suture Scissors 4 3/4" (12.1 cm), Extra Delicate, Smooth Jaws
- 340-535 Olsen-Hegar Needle Holders Combined with Suture Scissors 4 3/4" (12.1 cm), Extra Delicate, Serrated Jaws
- 340-554 Olsen-Hegar Needle Holders Combined with Suture Scissors 5 1/2" (14 cm), Serrated Jaws
- 340-653 Olsen-Hegar Needle Holders Combined with Suture Scissors 6 1/2" (16.5 cm), Serrated Jaws
- 340-655 Olsen-Hegar Needle Holders Combined with Suture Scissors 7 1/2" (18.4 cm), Serrated Jaws
- 340-670 Finochietto Needle Holders, 10 1/2" (26.7 cm) Angled Jaws



## TUNGSTEN CARBIDE



## NEEDLE HOLDERS TUNGSTEN CARBIDE INSERTS



342-105  
342-110  
342-125

- 341-008 Heaney Needle Holders, 8"
- 341-776 DeBakey Type Needle Holders, 7"
- 341-729 DeBakey Type Needle Holders, 9"
- 341-800 DeBakey Type Needle Holders, 10-1/4"
- 342-006 Stratte Needle Holders, 9"
- 342-055 Kalman (Ryder) Needle Holders, 5"
- 342-071 Kalman (Ryder) Needle Holders, 7"
- 342-097 Kalman (Ryder) Needle Holders, 9"
- 342-105 Mathieu Needle Holders, 5.5"
- 342-110 Mathieu Needle Holders, 6.5"
- 342-125 Mathieu Needle Holder, 8"





## TUNGSTEN CARBIDE

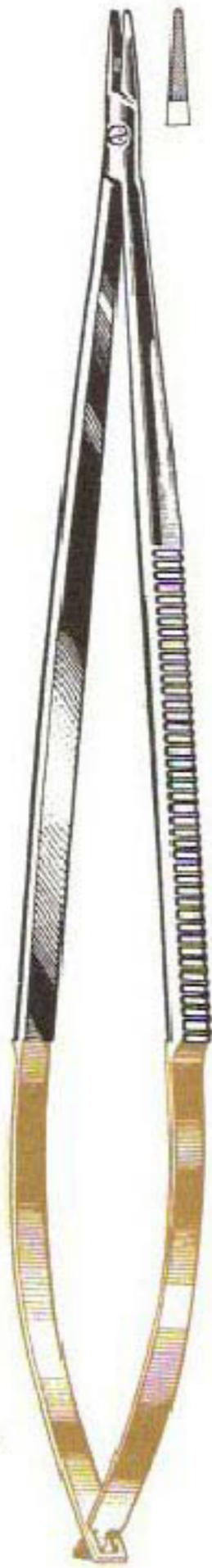

342-130



342-135

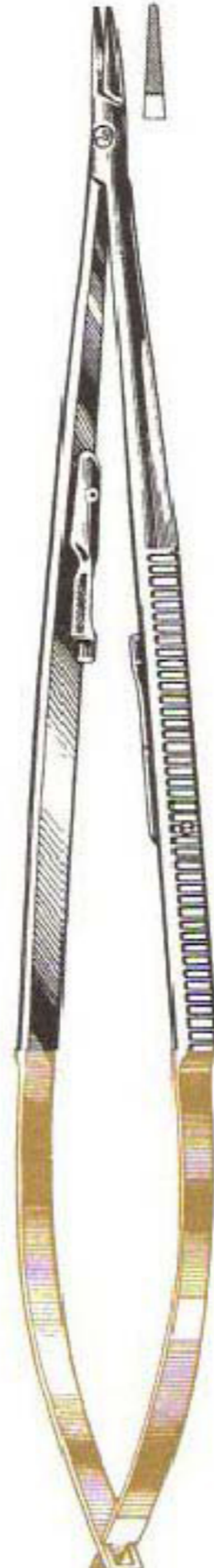

342-140



342-145

### TUNGSTEN CARBIDE

- 342-130 Jacobson Microvascular Needle Holder, 7", (17.8 cm), straight, w/o lock, serrated jaws, TC
- 342-135 Jacobson Microvascular Needle Holder, 7", (17.8 cm), curved, w/o lock, serrated jaws, TC
- 342-140 Jacobson Microvascular Needle Holder, 7", (17.8 cm), straight, with lock, serrated jaws, TC
- 342-145 Jacobson Microvascular Needle Holder, 7", (17.8 cm), curved, with lock, serrated jaws, TC

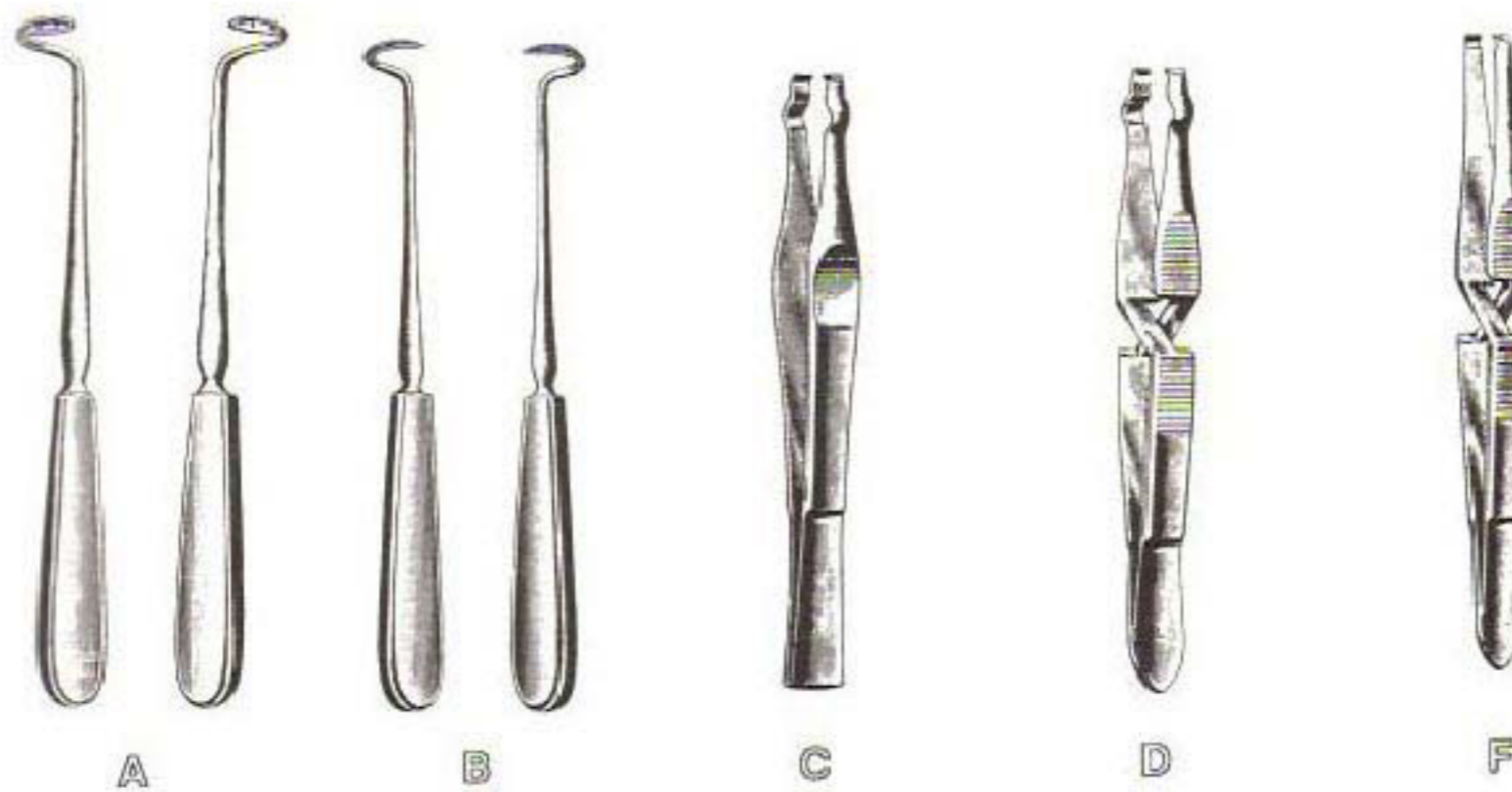

## SUTURE SUNDRIES



- |          |         |   |
|----------|---------|---|
| <b>A</b> | 380-055 | Deschamps Ligature Carriers, Blunt, Right, 8" |
|          | 380-063 | Deschamps Ligature Carriers, Blunt, Left, 8"  |
| <b>B</b> | 380-105 | Deschamps Ligature Carriers, Sharp, Right, 8" |
|          | 380-113 | Deschamps Ligature Carriers, Sharp, Left, 8"  |
| <b>C</b> | 380-154 | Wachtenfeld Clip Forceps, 5"                  |
| <b>D</b> | 380-204 | Wachtenfeld Clip Forceps, Cross Action, 5"    |
| <b>E</b> | 380-253 | Michel Applying and Removing Forceps, 5"      |
| <b>F</b> | 380-303 | Hegenbarth Clip Forceps, 5"                   |



## SUTURE SUNDRIES

- A 380-352 Michel Clip Applying Forceps, 5"
- B 380-402 Heath (Richter) Clip Remover, 5-1/4"
- C 380-519 Michel Wound Clips, 11mm, Per 1,000  
380-543 Michel Wound Clips, 14mm, Per 1,000  
380-568 Michel Wound Clips, 16mm, Per 1,000  
380-584 Michel Wound Clips, 18mm, Per 1,000  
380-626 Michel Wound Clips, 22mm, Per 1,000
- D 380-907 Approximation Forceps, 5 x 6 Teeth, Cross Action, 4"

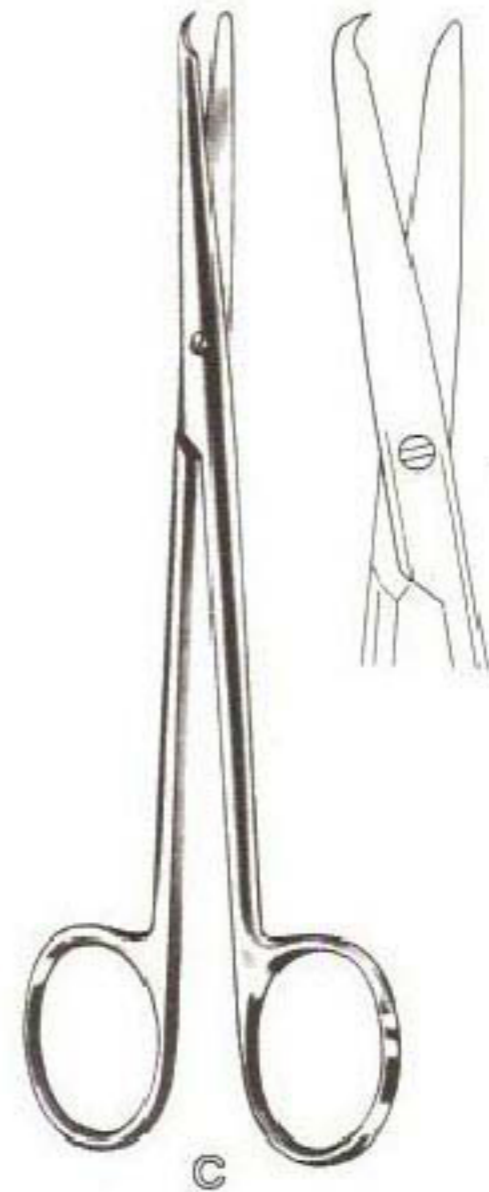

### STITCH SCISSORS

- A 381-053 Heath Suture Scissors, Serrated Blade, 6-1/4"
- B 381-103 Brook Stitch Scissors, 6"
- C 381-152 Long Oral Surgery (Buck) Scissors, 6" (15.2 cm)

### STAINLESS STEEL WIRE

- D 381-201 Stainless Steel Wire, 1 Oz. Spools, 18 Gauge
- 381-202 Stainless Steel Wire, 1 Oz. Spools, 20 Gauge
- 381-228 Stainless Steel Wire, 1 Oz. Spools, 22 Gauge
- 381-244 Stainless Steel Wire, 1 Oz. Spools, 24 Gauge
- 381-251 Stainless Steel Wire, 1 Oz. Spools, 25 Gauge
- 381-269 Stainless Steel Wire, 1 Oz. Spools, 26 Gauge
- 381-285 Stainless Steel Wire, 1 Oz. Spools, 28 Gauge
- 381-301 Stainless Steel Wire, 1 Oz. Spools, 30 Gauge
- 381-327 Stainless Steel Wire, 1 Oz. Spools, 32 Gauge
- 381-343 Stainless Steel Wire, 1 Oz. Spools, 34 Gauge
- 381-350 Stainless Steel Wire, 1 Oz. Spools, 35 Gauge
- 381-368 Stainless Steel Wire, 1 Oz. Spools, 36 Gauge



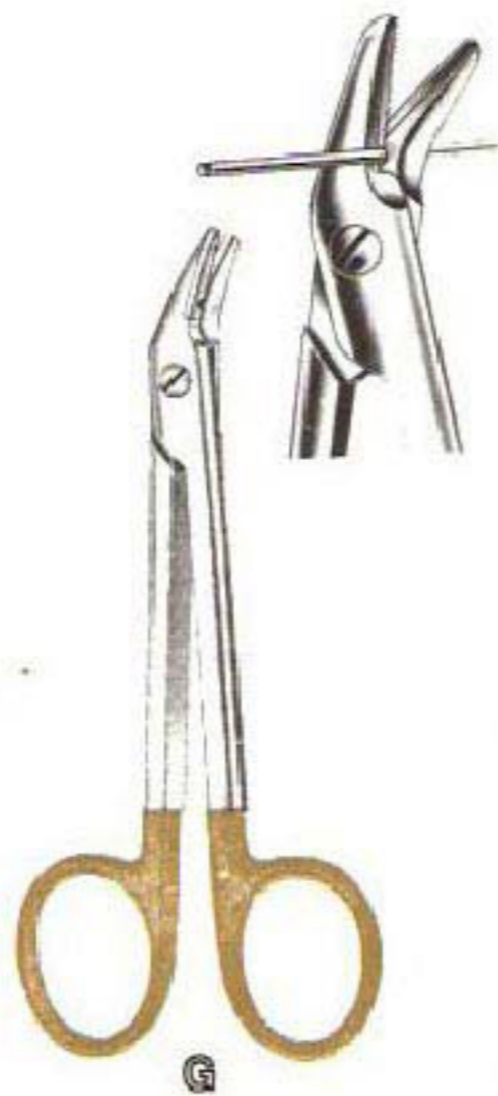

## STITCH SCISSORS

- 381-459 LITTAUER Jr. Stitch Scissors, 4-1/2" (11.4 cm), Light pattern
- 381-558 LITTAUER Stitch Scissors, 5-1/2" (14 cm), Standard Pattern
- B** 381-574 NORTHBENT Stitch Scissors, 4-3/4" (12.1 cm), Curved, Light Pattern
- C** 381-608 SHORTBENT Stitch Scissors, 3-1/2" (8.9 cm), Curved, Delicate
- D** 106-646 CROWN Stitch Scissors, 4-1/2" (11.4 cm), Angled, Delicate
- E** 381-657 SPENCER Stitch Scissors, 3-1/2" (8.9 cm), Delicate
- F** 381-707 ROGER Wire Scissors, 4-3/4" (12.1 cm), Angled to Side
- G** 381-715 ROGER Wire Scissors, 4-3/4" (12.1 cm), Angled to Side, Tungsten Carbide Inserts

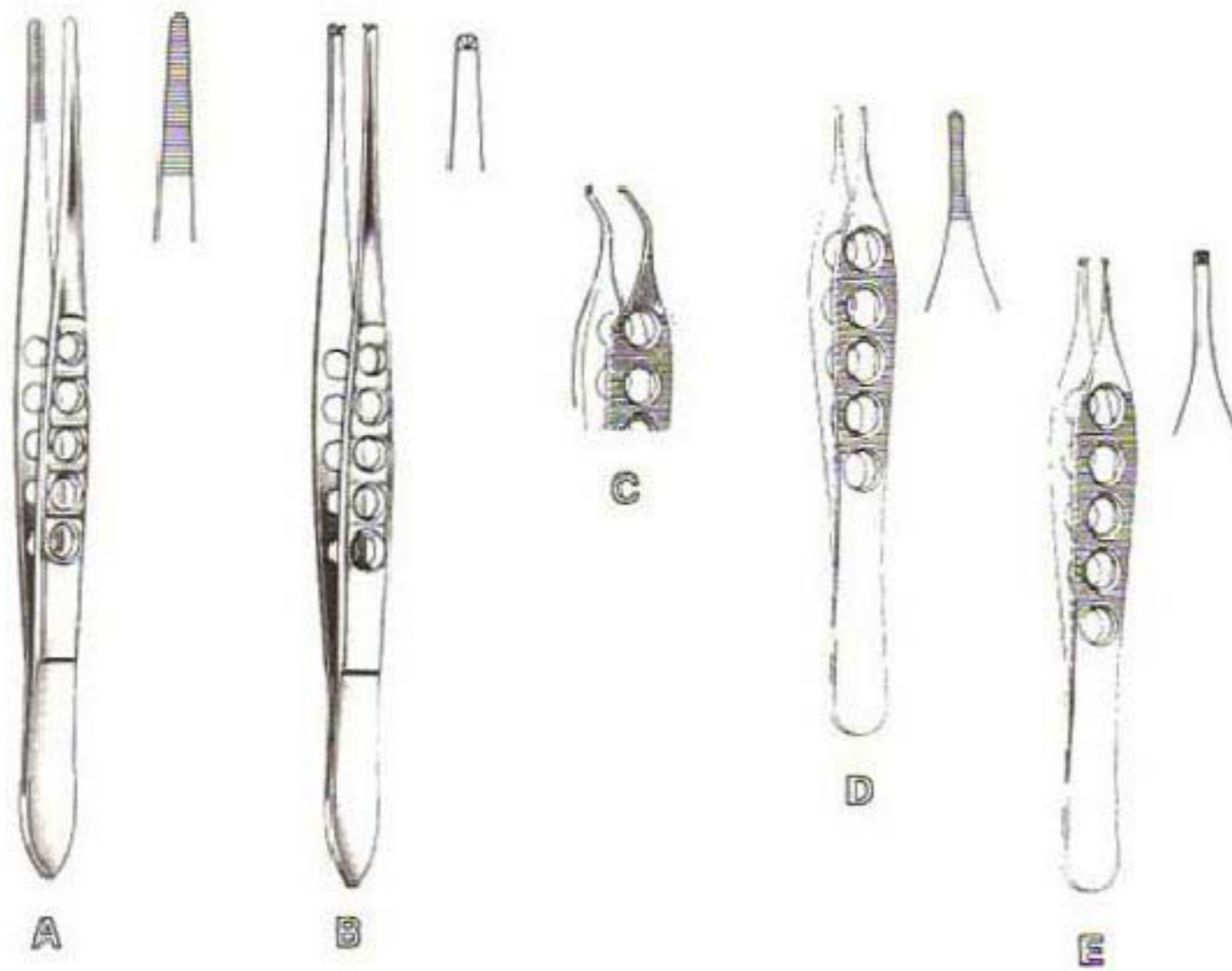

### DRESSING and TISSUE FORCEPS FENESTRATED HANDLES

- |          |         |   |
|----------|---------|---|
| <b>A</b> | 420-410 | Dressing Forceps 5 ½" (14.5 cm), Serrated Tips, Lightweight, Fenestrated Handles            |
| <b>B</b> | 420-415 | Tissue Forceps 5 ½" (14.5 cm), 1x2 Teeth, Lightweight, Fenestrated Handles                  |
| <b>C</b> | 420-420 | Adson Tissue Forceps 4 ¾" (12.1 cm), 1x2 Teeth, Lightweight Fenestrated Handles, Angled Tip |
| <b>D</b> | 420-425 | Adson Tissue Forceps, 4 ¾" (12.1 cm), Serrated, Lightweight Fenestrated Handles             |
| <b>E</b> | 420-430 | Adson Tissue Forceps, 4 ¾" (12.1 cm), 1x2 Teeth, Lightweight Fenestrated Handles            |



### DRESSING and TISSUE FORCEPS FENESTRATED HANDLES

- A** 420-435 Adson Tissue and Suture Forceps 4 3/4" (12.1 cm), 1x2 Teeth with Tying Platform, Lightweight Fenestrated Handles
- B** 420-440 Brown-Adson Tissue Forceps, 4 1/4" (12.1 cm), 7x7 Side Grasping Teeth Lightweight Fenestrated Handles
- C** 420-445 Adson Dressing Forceps, 4 3/4" (12.1 cm), Cross Serrated Tips, Tungsten Carbide insert, Lightweight Fenestrated Handles
- D** 420-450 McIndoe Dressing Forceps, 6" (15.2 cm), Serrated, Lightweight Fenestrated Handles
- E** 640-052 DeBakey Tissue Forceps, 6" (15.2 cm), Atraumatic Teeth 1.5 mm Wide Tips



420-455  
through  
420-620



420-802



420-810



420-828



420-057

## DRESSING FORCEPS

- |         |  |
|---------|--|
| 420-455 | Dressing Forceps, Serrated Tips, 4-1/2"                      |
| 420-505 | Dressing Forceps, Serrated Tips, 5"                          |
| 420-554 | Dressing Forceps, Serrated Tips, 5-1/2"                      |
| 420-562 | Dressing Forceps, Serrated Tips, 6"                          |
| 420-588 | Dressing Forceps, Serrated Tips, 8"                          |
| 420-604 | Dressing Forceps, Serrated Tips, 10"                         |
| 420-620 | Dressing Forceps, Serrated Tips, 12"                         |
| 420-802 | Eye Dressing Forceps, Straight, Extra Fine, Serrated, 4"     |
| 420-810 | Eye Dressing Forceps, Half Curved, Extra Fine, Serrated, 4"  |
| 420-828 | Eye Dressing Forceps, Fully Curved, Extra Fine, Serrated, 4" |
| 421-057 | Dressing Forceps, Extra Fine, Serrated Tips, 5-1/2"          |





421-156



421-453  
through  
421-628



421-800



421-818



421-826

## TISSUE FORCEPS

421-156	Tissue Forceps, Extra Fine, 1 x 2 Teeth, 5-1/2"
421-453	Tissue Forceps, 1 x 2 Teeth, 4-1/2"
421-503	Tissue Forceps, 1 x 2 Teeth, 5"
421-552	Tissue Forceps, 1 x 2 Teeth, 5-1/2"
421-560	Tissue Forceps, 1 x 2 Teeth, 6"
421-586	Tissue Forceps, 1 x 2 Teeth, 8"
421-602	Tissue Forceps, 1 x 2 Teeth, 10"
421-628	Tissue Forceps, 1 x 2 Teeth, 12"
421-800	Iris Tissue Forceps, Straight, Extra Fine, 1 x 2 Teeth, 4"
421-818	Iris Tissue Forceps, Half Curved, Extra Fine 1 x 2 Teeth, 4"
421-826	Iris Tissue Forceps, Fully Curved, Extra Fine, 1 x 2 Teeth, 4"

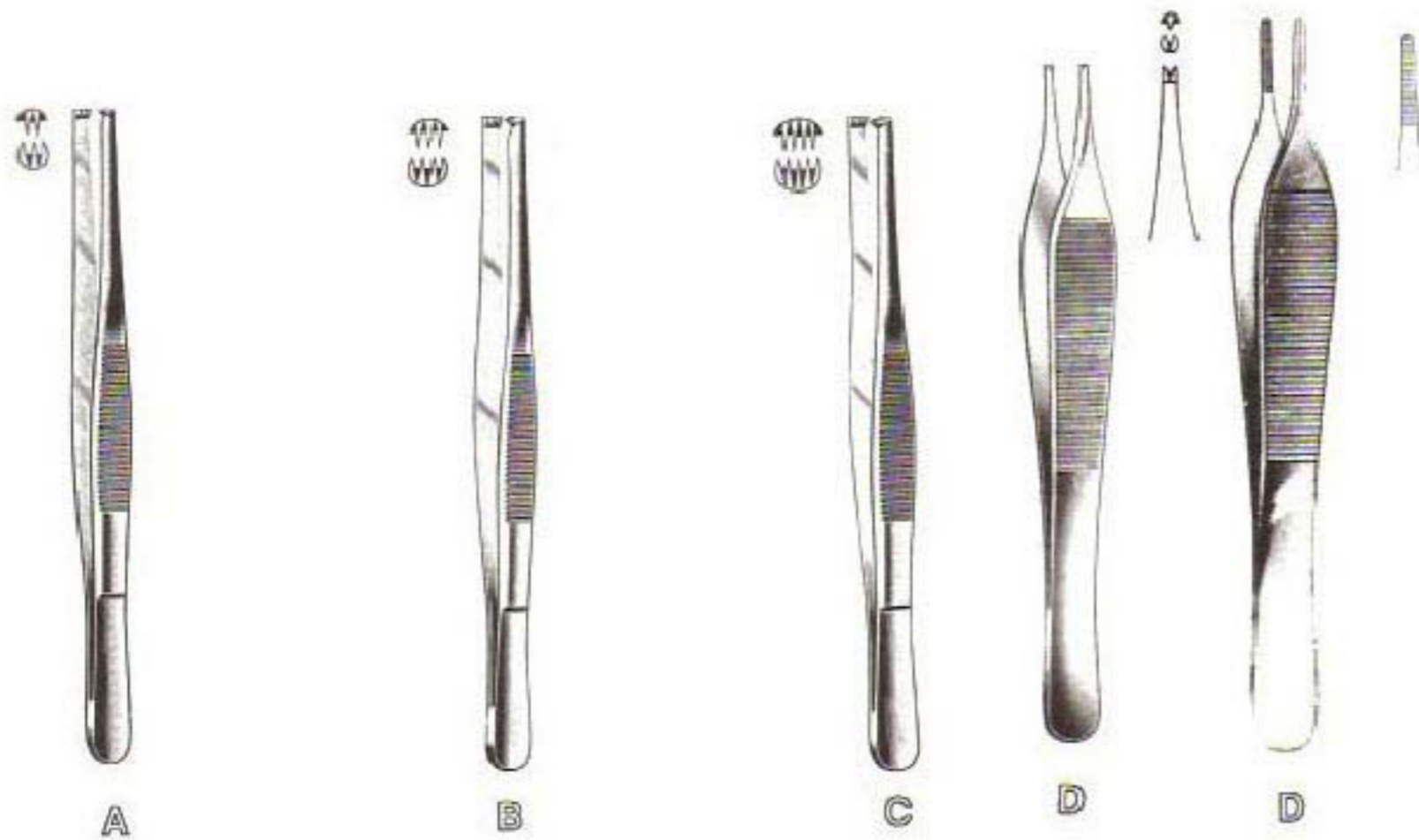

## TISSUE FORCEPS



- A** 422-188 Tissue Forceps, 2 x 3 Teeth, 5"  
 422-550 Tissue Forceps, 2 x 3 Teeth, 5-1/2"  
 422-568 Tissue Forceps, 2 x 3 Teeth, 6"
- B** 423-558 Tissue Forceps, 3 x 4 Teeth, 5-1/2"  
 423-566 Tissue Forceps, 3 x 4 Teeth, 6"
- C** 423-569 Tissue Forceps, 4 x 5 Teeth, 6"
- D** 423-608 Ewald Forceps, Serrated Tips, 4-3/4"  
 423-616 Ewald Forceps, 1 x 2 Teeth, 4-3/4"
- E** 423-707 Semkin Dressing Forceps, Serrated Tips, 4-3/4"
- F** 423-715 Semkin Tissue Forceps, 1 x 2 Teeth, 4-3/4"  
 423-723 Semkin Tissue Forceps, 2 x 3 Teeth, 4-3/4"





423-806



423-814  
423-822



423-855



423-905



423-954



423-056



1,5 mm

### DRESSING and TISSUE FORCEPS

- 423-806 Adson Dressing Forceps, Serrated, 4 3/4"
- 423-814 Adson Tissue Forceps, 1x2 Teeth, 4 3/4"
- 423-822 Adson Tissue Forceps, 2x3 Teeth, 4 3/4"
- 423-855 Brown-Adson Tissue Forceps, Tungsten Carbide Inlays, 4 3/4"
- 423-905 Brown-Adson Tissue Forceps, 4 3/4", 7x7 Side Grasping Teeth
- 423-954 Brown Tissue Forceps, 6", 8x8 Side Grasping Teeth
- 423-056 DeBakey Adson Tissue Forceps, (12.1cm) 1.5mm wide Tips, 4 3/4"

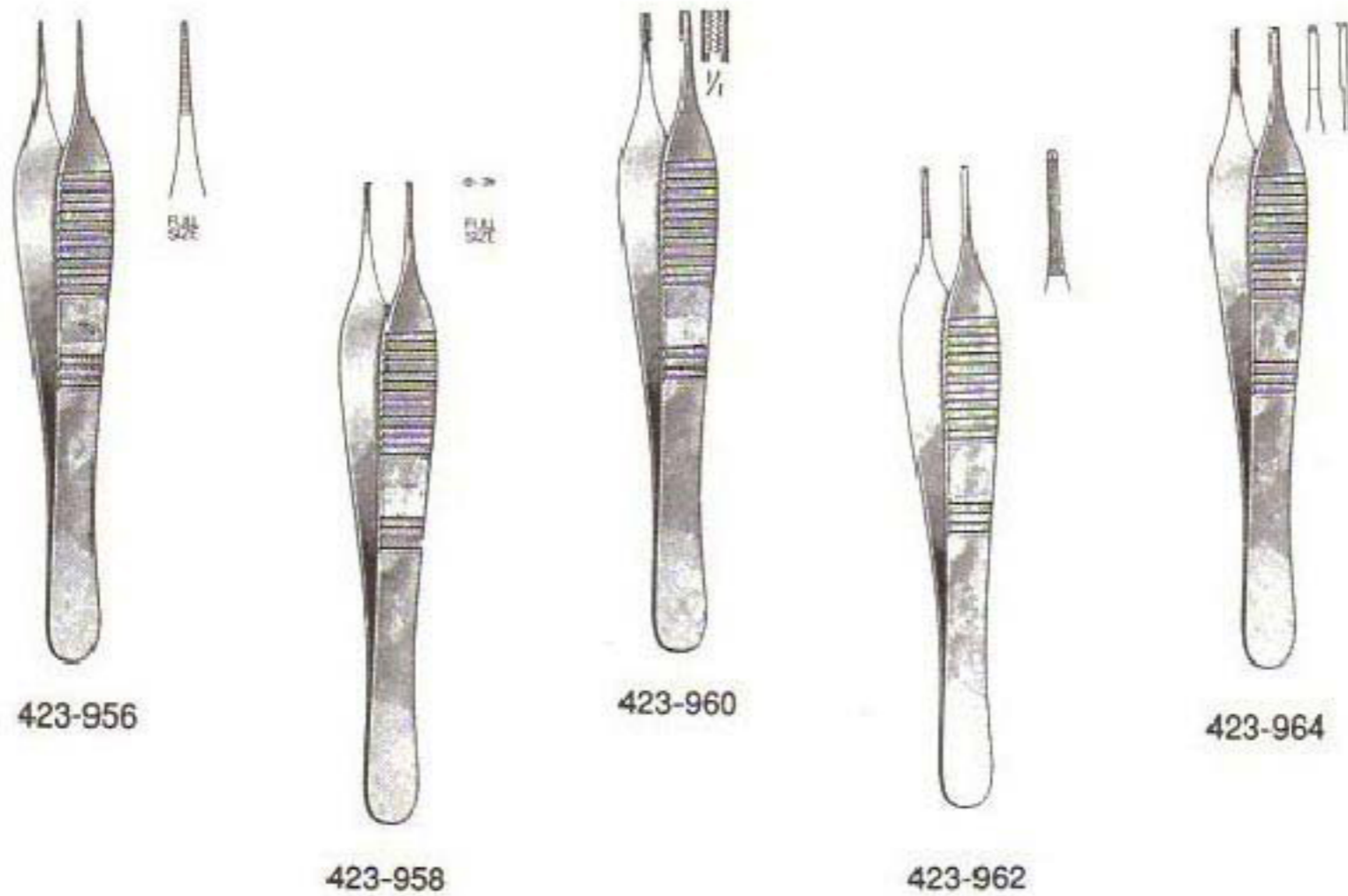

### DRESSING and TISSUE FORCEPS

- 423-956 Micro Adson Dressing Forceps, 4-3/4", Serrated Jaws 0.5 mm Wide
- 423-958 Micro Adson Tissue Forceps, 4-3/4", 1 x 2 Teeth Jaws 0.5mm Wide
- 423-960 Brown-Adson Tissue Forceps, 8 x 8 Fine Teeth, Side Grasping
- 423-962 Adson Tissue Forceps, 4-3/4", 1 x 2 Teeth, and Serrated Delicate
- 423-964 Adson Tissue and Suture Forceps, 4-3/4", 1 x 2 Teeth with Tying Platform



A



B



C



D



E

### DRESSING and TISSUE FORCEPS

- A 424-705 Potts-Smith Forceps, Serrated Tips, 7"
- 424-804 Potts-Smith Forceps, Serrated Tips, 8-1/4"
- 424-903 Potts-Smith Forceps, Serrated Tips, 9-1/2"
- B 424-713 Potts-Smith Forceps, 1 x 2 Teeth, 7"
- 424-812 Potts-Smith Forceps, 1 x 2 Teeth, 8-1/4"
- 424-911 Potts-Smith Forceps, 1 x 2 Teeth, 9-1/2"
- C 425-058 Bonney Tissue Forceps, 1 x 2 Teeth, 6-3/4"
- D 425-165 Russian Tissue Forceps, 6"
- 425-181 Russian Tissue Forceps, 8"
- 425-207 Russian Tissue Forceps, 10"
- E 425-256 Mayo-Russian Tissue Forceps, 9"
- F 425-306 Kelly Tissue Forceps, 1 x 2 Teeth, 9"
- 425-355 Kelly Tissue Forceps, 3 x 4 Teeth, 9"
- G 425-405 Singley (Tuttle) Tissue Forceps, 9"



F



D



A



B



C



D



E

### DRESSING and TISSUE FORCEPS

- A 424-705 Potts-Smith Forceps, Serrated Tips, 7"
- 424-804 Potts-Smith Forceps, Serrated Tips, 8-1/4"
- 424-903 Potts-Smith Forceps, Serrated Tips, 9-1/2"
  
- B 424-713 Potts-Smith Forceps, 1 x 2 Teeth, 7"
- 424-812 Potts-Smith Forceps, 1 x 2 Teeth, 8-1/4"
- 424-911 Potts-Smith Forceps, 1 x 2 Teeth, 9-1/2"
  
- C 425-058 Bonney Tissue Forceps, 1 x 2 Teeth, 6-3/4"
  
- D 425-165 Russian Tissue Forceps, 6"
- 425-181 Russian Tissue Forceps, 8"
- 425-207 Russian Tissue Forceps, 10"
  
- E 425-256 Mayo-Russian Tissue Forceps, 9"
- F 425-306 Kelly Tissue Forceps, 1 x 2 Teeth, 9"
- 425-355 Kelly Tissue Forceps, 3 x 4 Teeth, 9"
  
- G 425-405 Singley (Tuttle) Tissue Forceps, 9"



F



D

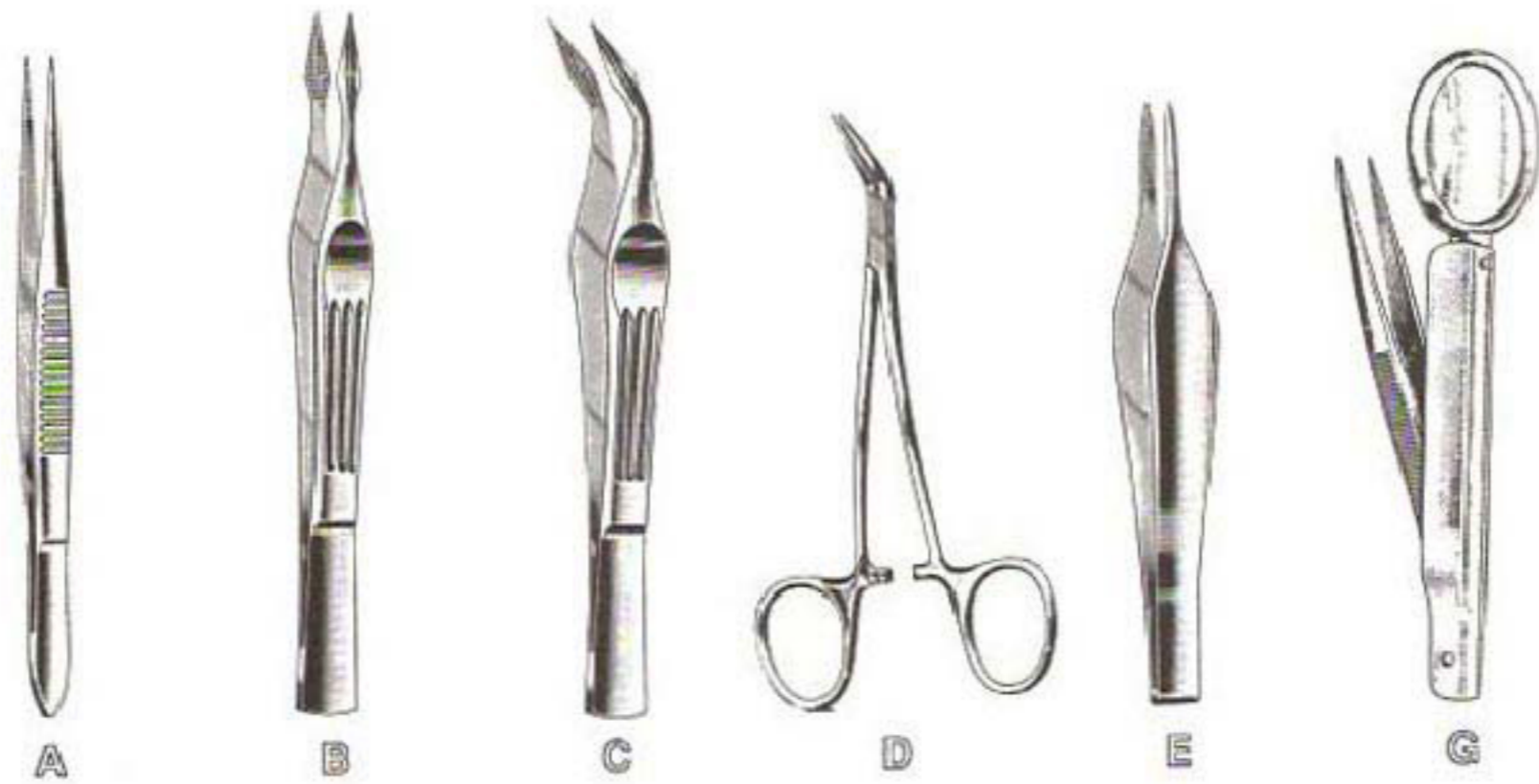

### SPLINTER FORCEPS



- A** 440-354 Splinter Forceps, Plain, 3 1/2"  
440-453 Splinter Forceps, 4 1/2"
- B** 440-503 Carmalt (Walter) Splinter Forceps, Straight, 4 3/4"
- C** 440-511 Carmalt (Walter) Splinter Forceps, Angled, 4 3/4"
- D** 440-552 Peet Splinter Forceps, 4 3/4"
- 440-636 Feilchenfeld Splinter Forceps, 3"
- 440-644 Feilchenfeld Splinter Forceps, 4 1/2"
- F** 440-701 Virtus Splinter Forceps, 6"
- G** 440-819 Splinter Forceps with Magnifier, 3"
- H** 440-825 Stieglitz (Williams) Splinter Forceps  
5 1/2" (14cm), Straight
- 440-830 Stieglitz (Williams) Splinter Forceps  
5 1/2" (14cm), 45° Angle
- 440-835 Stieglitz (Williams) Splinter Forceps  
5 1/2" (14cm), Right Angle





440-958



441-006  
441-014



441-055



441-105

## CILIA FORCEPS

- 440-958 Douglas Cilia Forceps, 3"
- 441-006 Cilia Forceps, Plain, Narrow, 3-1/2"
- 441-014 Cilia Forceps, Plain, Broad, 3-1/2"
- 441-055 Bergh Cilia Forceps, 3-1/2"
- 441-105 Littauer Cilia Forceps, 3-1/2"





A

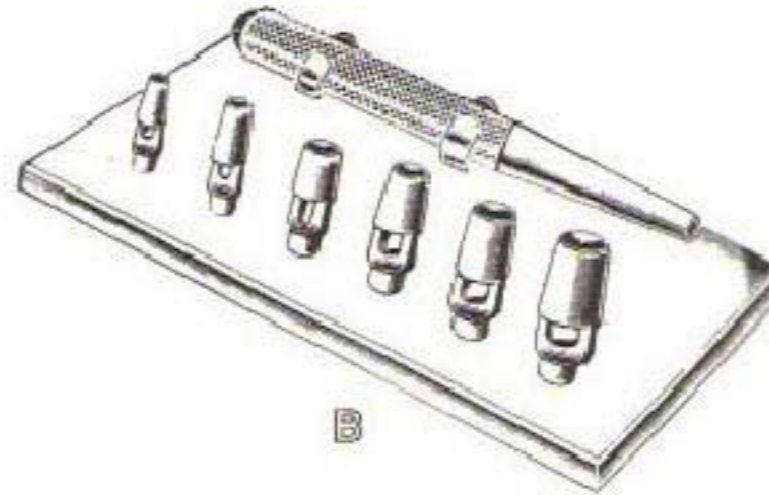

B

## DERMAL INSTRUMENTS

- |   |         |                                  |
|---|---------|----------------------------------|
| A | 460-021 | Keyes Dermal Punch, 1mm, 3-3/4"  |
|   | 460-022 | Keyes Dermal Punch, 2mm, 3-3/4"  |
|   | 460-030 | Keyes Dermal Punch, 3mm, 3-3/4"  |
|   | 460-048 | Keyes Dermal Punch, 4mm, 3-3/4"  |
|   | 460-055 | Keyes Dermal Punch, 5mm, 3-3/4"  |
|   | 460-063 | Keyes Dermal Punch, 6mm, 3-3/4"  |
|   | 460-071 | Keyes Dermal Punch, 7mm, 3-3/4"  |
|   | 460-089 | Keyes Dermal Punch, 8mm, 3-3/4"  |
|   | 460-090 | Keyes Dermal Punch, 10mm, 3-3/4" |
| B | 461-004 | Keyes Dermal Punch, Set          |
|   | 461-020 | Keyes Replacement Tips Only, 2mm |
|   | 461-038 | Keyes Replacement Tips Only, 3mm |
|   | 461-045 | Keyes Replacement Tips Only, 4mm |
|   | 461-053 | Keyes Replacement Tips Only, 5mm |
|   | 461-061 | Keyes Replacement Tips Only, 6mm |
|   | 461-079 | Keyes Replacement Tips Only, 7mm |



A

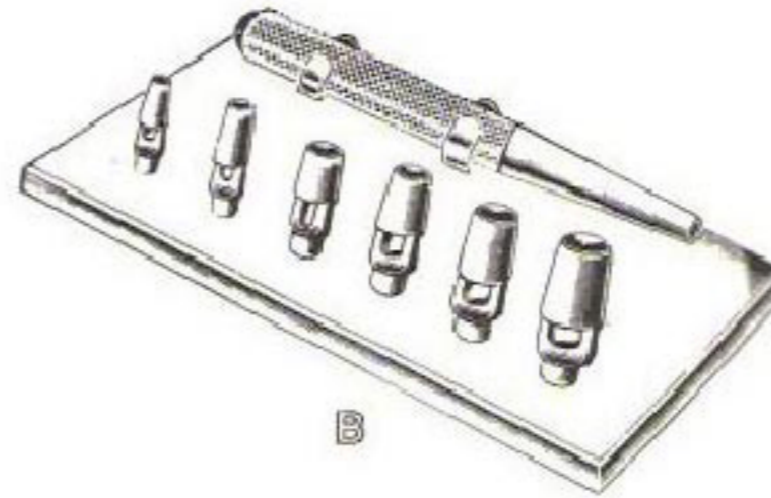

B

## DERMAL INSTRUMENTS

A	460-021	Keyes Dermal Punch, 1mm, 3-3/4"
	460-022	Keyes Dermal Punch, 2mm, 3-3/4"
	460-030	Keyes Dermal Punch, 3mm, 3-3/4"
	460-048	Keyes Dermal Punch, 4mm, 3-3/4"
	460-055	Keyes Dermal Punch, 5mm, 3-3/4"
	460-063	Keyes Dermal Punch, 6mm, 3-3/4"
	460-071	Keyes Dermal Punch, 7mm, 3-3/4"
	460-089	Keyes Dermal Punch, 8mm, 3-3/4"
	460-090	Keyes Dermal Punch, 10mm, 3-3/4"
B	461-004	Keyes Dermal Punch, Set
	461-020	Keyes Replacement Tips Only, 2mm
	461-038	Keyes Replacement Tips Only, 3mm
	461-045	Keyes Replacement Tips Only, 4mm
	461-053	Keyes Replacement Tips Only, 5mm
	461-061	Keyes Replacement Tips Only, 6mm
	461-079	Keyes Replacement Tips Only, 7mm



461-509



461-541  
461-558



461-608



461-657



461-658

### DERMAL INSTRUMENTS

- 461-509 Schamberg Comedone Extractor, 4"
- 461-541 Saalfield Comedone Extractor, 4-1/2"
- 461-558 Saalfield Comedone Extractor, 5-3/4"
- 461-608 Unna Comedone Extractor, 5-3/4"
- 461-657 Comedone Extractor, Double Ended, Lancet and Cap, 6"
- 461-658 Ingrown Toe Nail Forceps, English (Anvil) Pattern, 5"
- 461-660 Mycotic Nail Nipper, Concave, Barrel Spring, Double Action, 6"

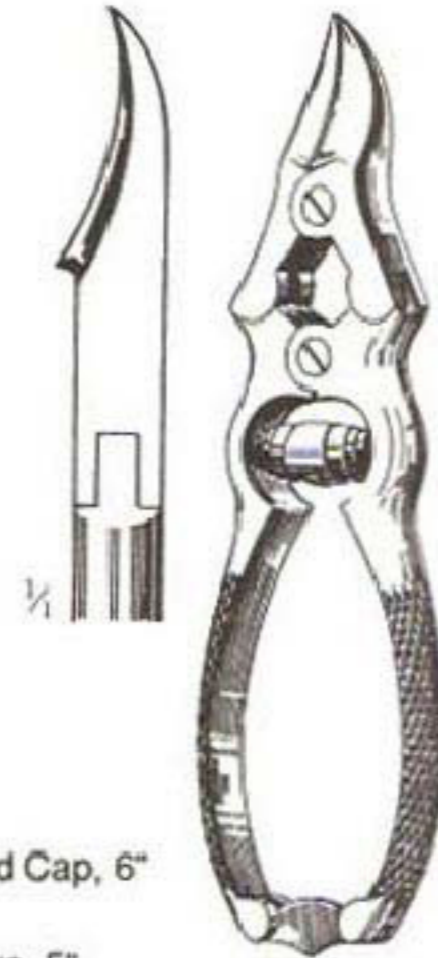

461-660



A



B



C



D



E

A

461-707 Nail Nippers, Barrel Spring, Chrome, 4-1/2"

461-756 Nail Nippers, Barrel Spring, Chrome, 5-1/2"

B

461-772 Nail Nippers, Concave Jaws, Single-Spring, Chrome, 4-1/2"

C

461-780 Cuticle Nippers, Convex, Stainless, 4-1/2"

461-806 Cuticle Nippers, Convex, Chrome, 4-1/2"

D

461-814 Tissue Nippers, Convex, Double Spring, Stainless, 4-1/2"

E

461-855 Nail Nippers, Concave, Double Spring, Chrome, 5-1/2"

461-905 Nail Nippers, Concave, Double Spring, Stainless, 5-1/2"

F

461-954 Nail Nippers, Concave, Double Spring, Angular, Chrome, 5-1/2"

461-962 Nail Nippers, Concave, Double Spring, Angular, Stainless, 5-1/2"

## DERMAL INSTRUMENTS



F



## DERMAL INSTRUMENTS

- |         |   |
|---------|---|
| 462-002 | LITTAUER Nail Nipper, Straight Jaw, Double Spring, 6"                       |
| 462-004 | WHITE Toe Nail Clipper, 4-1/2" (11.5 cm)                                    |
| 462-051 | Finger Ring Cutter with circular saw, 6-1/2" (16.5 cm)                      |
| 462-055 | Finger Ring Cutter with circular saw blade, 6-1/2" (16.5 cm), heavy pattern |
| 462-069 | Replacement Blade for Finger Ring Cutter                                    |
| 462-101 | Finger Nail Drill, 4" (10.2 cm), with 3 drill points                        |
| 462-119 | Set of 3 Drill Points, small, medium and large size, for finger nail drills |

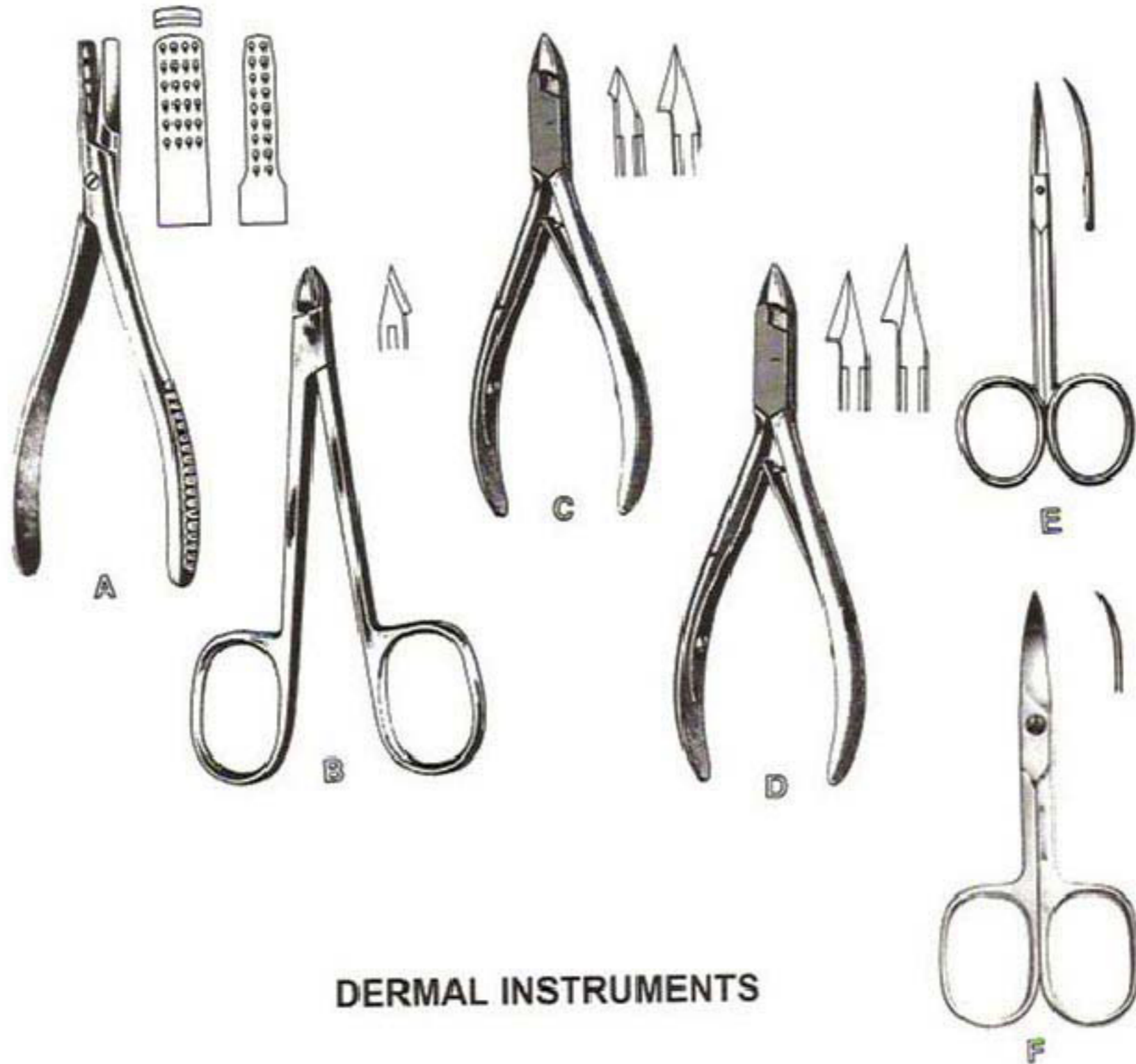

## DERMAL INSTRUMENTS

- |          |         |   |
|----------|---------|---|
| <b>A</b> | 461-684 | PLATYPUS Nail Pulling Forceps, 5-1/2" (14 cm), standard width jaws, stainless |
|          | 461-686 | PLATYPUS Nail Pulling Forceps, 5-1/2" (14 cm), narrow jaws, stainless         |
| <b>B</b> | 461-688 | Tissue and Cuticle Nipper, 4" (10.2 cm), straight jaws, ring handles          |
|          | 461-690 | Tissue and Cuticle Nipper, 4" (10.2 cm), convex jaws, stainless               |
| <b>C</b> | 461-692 | Tissue and Cuticle Nipper, 4-1/2" (11.4 cm), convex jaws, stainless           |
|          | 461-694 | Tissue and Cuticle Nipper, convex jaws, stainless                             |
| <b>D</b> | 461-696 | Tissue and Cuticle Nipper, convex jaws, heavy pattern, stainless              |
| <b>E</b> | 461-698 | Cuticle Scissors, Straight, 3-1/2" (9 cm)                                     |
|          | 461-700 | Cuticle Scissors, Curved, 3-1/2" (9 cm)                                       |
| <b>F</b> | 461-702 | Nail Scissors, Straight, 3-1/2" (9 cm)  |
|          | 461-704 | Nail Scissors, Curved, 3-1/2" (9 cm)  |



## SUCTION TUBES

- A** 480-053 Yankauer Suction Tube, Regular, Chrome, 11-3/4"
- B** 480-103 Yankauer Suction Tube, Threaded End, Chrome, 11-3/4"
- 480-111 Yankauer Replacement Tip Only
- C** 480-152 Yankauer Suction Tube with Detachable Handle, 9"
- D** 480-202 Yankauer (Andrews) Suction Tube, Pediatric, 8-1/2"

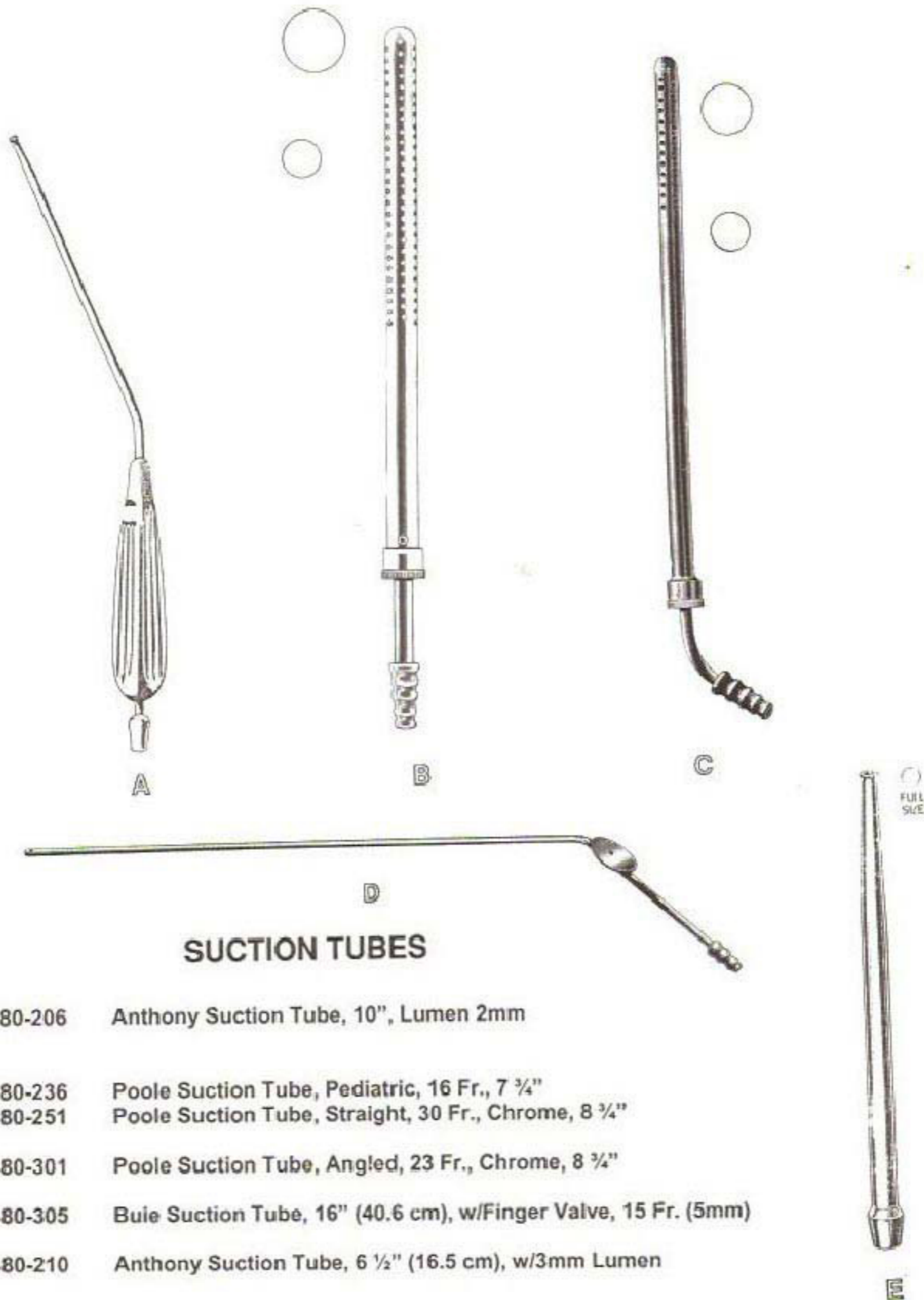

### SUCTION TUBES

- A** 480-206 Anthony Suction Tube, 10", Lumen 2mm
- B** 480-236 Poole Suction Tube, Pediatric, 16 Fr., 7 3/4"  
480-251 Poole Suction Tube, Straight, 30 Fr., Chrome, 8 3/4"
- C** 480-301 Poole Suction Tube, Angled, 23 Fr., Chrome, 8 3/4"
- D** 480-305 Buie Suction Tube, 16" (40.6 cm), w/Finger Valve, 15 Fr. (5mm)
- E** 480-210 Anthony Suction Tube, 6 1/2" (16.5 cm), w/3mm Lumen





A



B



C

## SUCTION TUBES

- |   |         |  |
|---|---------|--|
| A | 480-350 | Adson Suction Tube, Straight, 12 Fr., 8"   |
|   | 480-368 | Adson Suction Tube, Curved, 12 Fr., 8"     |
| B | 480-467 | Frazier Suction Tube, Straight, 6 Fr., 5"  |
|   | 480-468 | Frazier Suction Tube, Straight, 7 Fr., 5"  |
|   | 480-483 | Frazier Suction Tube, Straight, 8 Fr., 5"  |
|   | 480-489 | Frazier Suction Tube, Straight, 9 Fr., 5"  |
|   | 480-509 | Frazier Suction Tube, Straight, 10 Fr., 5" |
|   | 480-511 | Frazier Suction Tube, Straight, 11 Fr., 5" |
|   | 480-525 | Frazier Suction Tube, Straight, 12 Fr., 5" |
| C | 480-566 | Frazier Suction Tube, Angled, 6 Fr., 5"    |
|   | 480-573 | Frazier Suction Tube, Angled, 7 Fr., 5"    |
|   | 480-582 | Frazier Suction Tube, Angled, 8 Fr., 5"    |
|   | 480-595 | Frazier Suction Tube, Angled, 9 Fr., 5"    |
|   | 480-608 | Frazier Suction Tube, Angled, 10 Fr., 5"   |
|   | 480-616 | Frazier Suction Tube, Angled, 11 Fr., 5"   |
|   | 480-624 | Frazier Suction Tube, Angled, 12 Fr., 5"   |
| D | 480-633 | Baron Suction Tube, 3 Fr., 6-1/4"          |
|   | 480-635 | Baron Suction Tube, 5 Fr., 6-1/4"          |
|   | 480-637 | Baron Suction Tube, 7 Fr., 6-1/4"          |



D



480-756



480-822  
through  
480-921



NELSON  
481-010  
through  
481-044



481-100  
through  
481-160

## TROCAR AND BIOPSY NEEDLES

480-756	Duke Trocar Set
480-820	Ochsner (Improved) Trocar, 10 Fr., 6"
480-822	Ochsner (Improved) Trocar, 12 Fr., 6"
480-848	Ochsner (Improved) Trocar, 14 Fr., 6"
480-863	Ochsner (Improved) Trocar, 16 Fr., 6"
480-889	Ochsner (Improved) Trocar, 18 Fr., 6"
480-905	Ochsner (Improved) Trocar, 20 Fr., 6"
480-921	Ochsner (Improved) Trocar, 22 Fr., 6"
481-010	Patterson (Nelson) Trocar, Size 1, 8 1/4"
481-028	Patterson (Nelson) Trocar, Size 2, 8 1/4"
481-036	Patterson (Nelson) Trocar, Size 3, 8 1/4"
481-044	Patterson (Nelson) Trocar, Size 4, 8 1/4"

## MENGHINI BIOPSY NEEDLES

Improved Model, with built-in stop plug that never requires replacement

For Liver Biopsy Child Size - 40 mm long inside diameter		For Liver Biopsy Adult Size - 70 mm long inside diameter		For Kidney Biopsy 120 mm long inside diameter	
481-100	1 mm - 19 gauge	481-125	1 mm - 19 gauge	481-145	1 mm - 19 gauge
481-110	1.2 mm - 18 gauge	481-130	1.2 mm - 18 gauge	481-150	1.2 mm - 18 gauge
481-115	1.4 mm - 17 gauge	481-135	1.4 mm - 17 gauge	481-155	1.4 mm - 17 gauge
481-120	1.8 mm - 16 gauge	481-140	1.8 mm - 16 gauge	481-160	1.8 mm - 16 gauge



## HOOKS

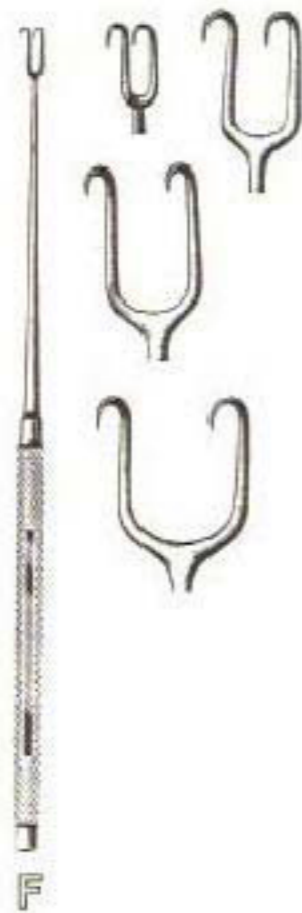

- |   |         |  |
|---|---------|--|
| A | 500-058 | Frazier Hook, Sharp, Delicate Prong, 5"    |
|   | 500-060 | Frazier Hook, Blunt, Delicate Prong, 5"    |
| B | 500-108 | Gillies Skin Hook, 7", Large               |
|   | 500-110 | Gillies Skin Hook, 7", Small               |
| C | 500-157 | Kilner Skin Hook, Fine Point, 6"           |
| D | 500-173 | Tyrell Hook, Delicate Prong, Sharp, 6"     |
|   | 500-181 | Tyrell Hook, Delicate Prong, Sharp, 6 1/4" |
| E | 500-207 | Joseph Skin Hook, Sharp, 6 1/4"            |
| F | 500-223 | Joseph Skin Hook, 2 Prongs, 2mm, 6 1/4"    |
|   | 500-256 | Joseph Skin Hook, 2 Prongs, 5mm, 6 1/4"    |
|   | 500-272 | Joseph Skin Hook, 2 Prongs, 7mm, 6 1/4"    |
|   | 500-306 | Joseph Skin Hook, 2 Prongs, 10mm, 6 1/4"   |



## RETRACTORS



- 500-308**    **Neivert Knife Guide and Retractor, 6 ½", Double End, Open Blade 14mm Wide**
- 500-310**    **Meyerding Skin Hook and Retractors, 6 ¼", Double End**
- 500-312**    **Cottle Skin Hook 5 ½", Small, Shallow Curve**
- 500-314**    **Cottle Skin Hook 5 ½", Small, Deep Curve**
- 500-316**    **Cottle Skin Hook 5 ½", Large, Deep Curve**
  
- 823-302**    **Aufricht Retractor Speculum, 6 ½", Solid Blade, 45mm Long**
- 861-302**    **Luer S-Shape Retractor, 5 ½", Double End 10x5mm and 14x9mm**



## RETRACTORS

- |          |         |   |
|----------|---------|---|
| <b>A</b> | 500-355 | Senn Miller Retractor, Sharp, 6-1/4"              |
|          | 500-363 | Senn (Miller) Retractor, Blunt, 6-1/4"            |
| <b>B</b> | 500-413 | Lahey Tissue Retractor, 1 Prong, 4-3/4"           |
|          | 500-421 | Lahey Tissue Retractor, 2 Prongs, 4-3/4"          |
|          | 500-439 | Lahey Tissue Retractor, 3 Prongs, 4-3/4"          |
| <b>C</b> | 500-496 | Guthrie Fixation Hook, 6"                         |
| <b>D</b> | 500-512 | Skin (Trachea) Retractor, 1 Prong, Sharp, 6-1/2"  |
|          | 500-520 | Skin (Trachea) Retractor, 2 Prongs, Sharp, 6-1/2" |
|          | 500-538 | Skin (Trachea) Retractor, 3 Prongs, Sharp, 6-1/2" |
|          | 500-553 | Skin (Trachea) Retractor, 1 Prong, Blunt, 6-1/2"  |
|          | 500-561 | Skin (Trachea) Retractor, 2 Prongs, Blunt, 6-1/2" |
|          | 500-579 | Skin (Trachea) Retractor, 3 Prongs, Blunt, 6-1/2" |
| <b>E</b> | 500-603 | Mathieu Retractor, Sharp, 6-1/4"                  |
|          | 500-641 | Mathieu Retractor, Blunt, 6-1/4"                  |



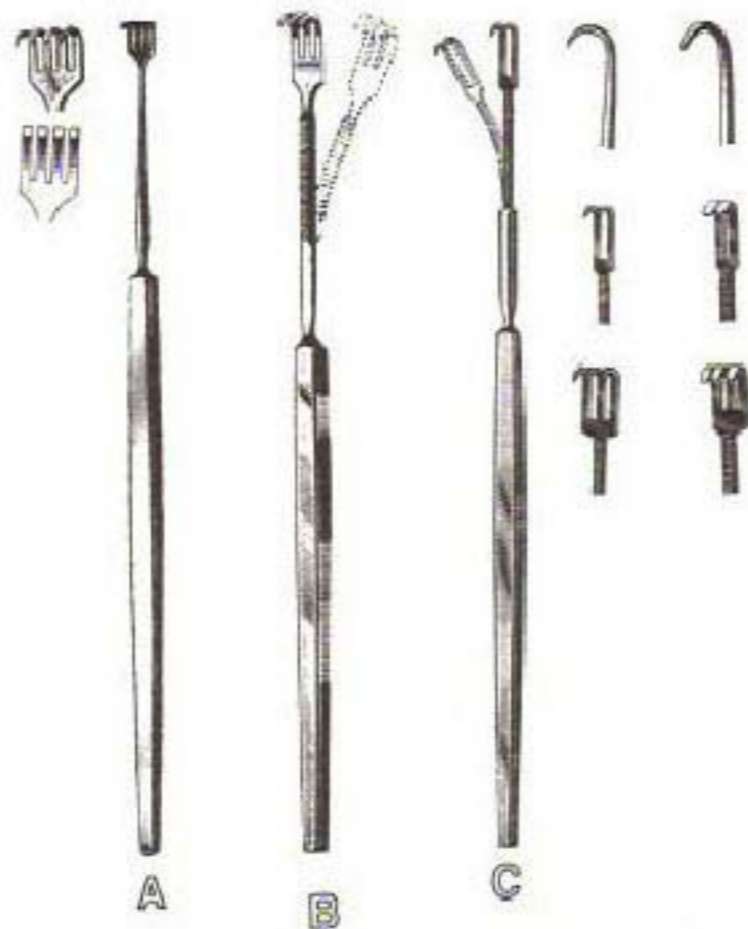

### RETRACTORS

- |          |         |  |
|----------|---------|--|
| <b>A</b> | 500-642 | Knapp Retractor, Sharp, 4 Prongs, 5 1/4"   |
|          | 500-644 | Knapp Retractor, Blunt, 4 Prongs, 5 1/4"   |
| <b>B</b> | 500-700 | Flexible Retractor, 3 Sharp Prongs, 5"     |
| <b>C</b> | 500-701 | Flexible Retractor, 1 Sharp Prong, 6"      |
|          | 500-702 | Flexible Retractor, 2 Sharp Prongs, 6"     |
|          | 500-703 | Flexible Retractor, 3 Sharp Prongs, 6"     |
|          | 500-711 | Flexible Retractor, 1 Blunt Prong, 6"      |
|          | 500-712 | Flexible Retractor, 2 Blunt Prongs, 6"     |
|          | 500-713 | Flexible Retractor, 3 Blunt Prongs, 6"     |
| <b>D</b> | 500-728 | Murphy Retractor, 2 Prongs, Sharp, 7 1/2"  |
|          | 500-736 | Murphy Retractor, 3 Prongs, Sharp, 7 1/2"  |
|          | 500-744 | Murphy Retractor, 4 Prongs, Sharp, 7 1/2"  |
|          | 500-769 | Murphy Retractor, 6 Prongs, Sharp, 7 1/2"  |
| <b>E</b> | 500-827 | Volkman Retractor, 2 Prongs, Sharp, 8 1/2" |
|          | 500-835 | Volkman Retractor, 3 Prongs, Sharp, 8 1/2" |
|          | 500-843 | Volkman Retractor, 4 Prongs, Sharp, 8 1/2" |
|          | 500-848 | Volkman Retractor, 6 Prongs, Sharp, 8 1/2" |
|          | 500-926 | Volkman Retractor, 2 Prongs, Blunt, 8 1/2" |
|          | 500-934 | Volkman Retractor, 3 Prongs, Blunt, 8 1/2" |
|          | 500-942 | Volkman Retractor, 4 Prongs, Blunt, 8 1/2" |
|          | 500-967 | Volkman Retractor, 6 Prongs, Blunt, 8 1/2" |

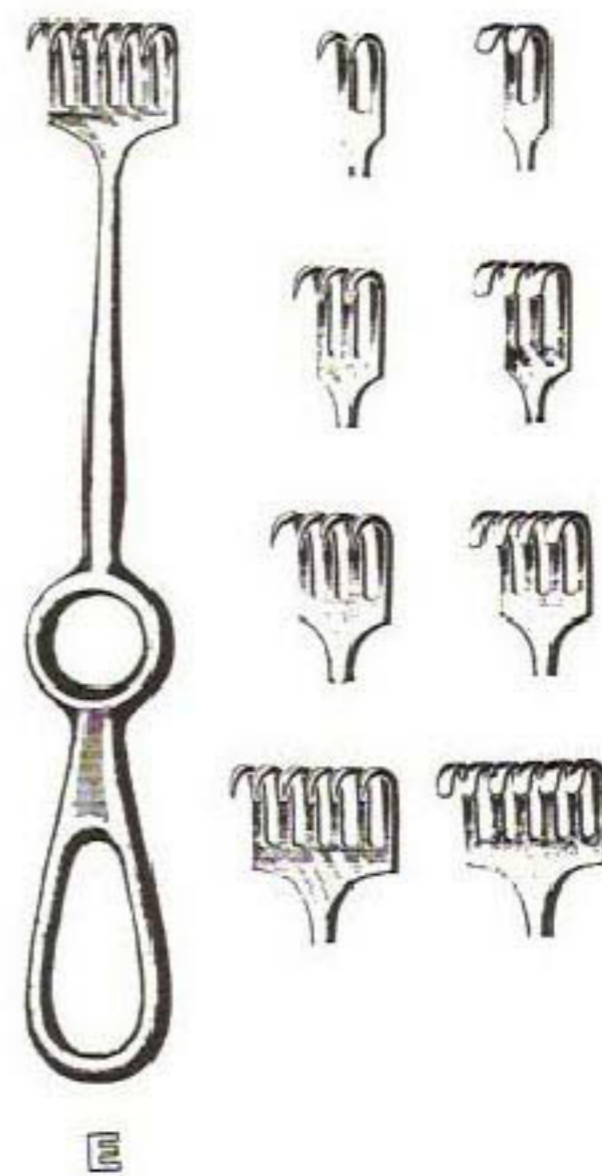



## RETRACTORS

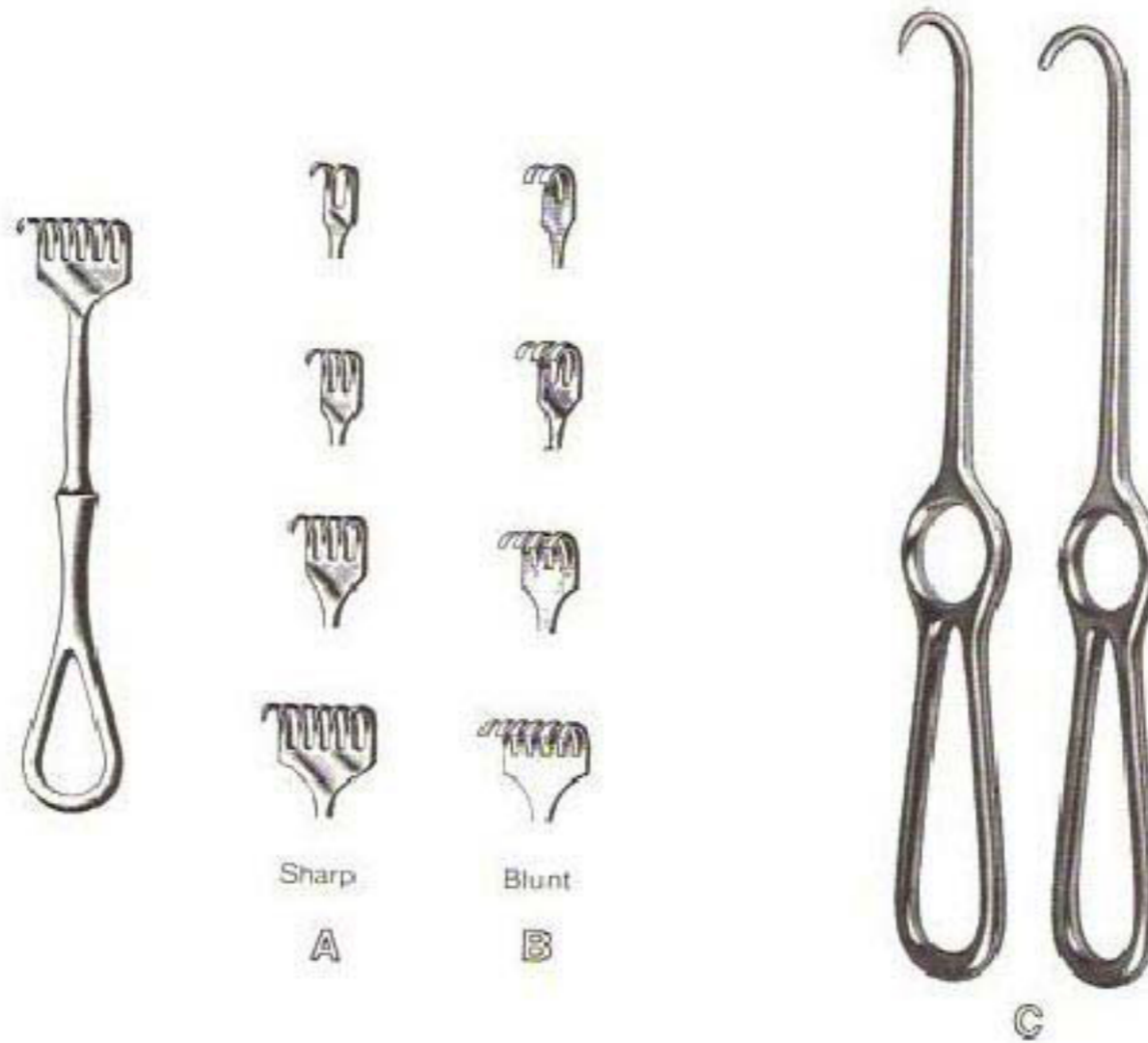

- |          |         |  |
|----------|---------|--|
| <b>A</b> | 500-968 | Volkman Finger Retractor, 2 Prongs, Sharp, 4 ½"              |
|          | 500-970 | Volkman Finger Retractor, 3 Prongs, Sharp, 4 ½"              |
|          | 500-971 | Volkman Finger Retractor, 4 Prongs, Sharp, 4 ½"              |
|          | 500-972 | Volkman Finger Retractor, 6 Prongs, Sharp, 4 ½"              |
| <b>B</b> | 500-974 | Volkman Finger Retractor, 2 Prongs, Blunt, 4 ½"              |
|          | 500-976 | Volkman Finger Retractor, 3 Prongs, Blunt, 4 ½"              |
|          | 500-978 | Volkman Finger Retractor, 4 Prongs, Blunt, 4 ½"              |
|          | 500-980 | Volkman Finger Retractor, 6 Prongs, Blunt, 4 ½"              |
| <b>C</b> | 500-984 | Volkman Hook Retractor, 9" (22.9cm)<br>Sharp Point 15mm Deep |
|          | 500-986 | Volkman Hook Retractor, 9" (22.9cm)<br>Blunt Tip 15mm Deep   |



### RETRACTORS

- A 501-007 Ollier Retractor, 4 Prongs, Blunt, 8-1/2"
- B 501-056 Israel Retractor, 4 Prongs, Blunt, 8-1/2"
- C 501-106 Cushing Retractor, Angled, 8"
- D 501-155 Cushing Vein Retractor, 8"







A



B



C



D



E

## RETRACTORS

- |   |         |   |
|---|---------|---|
| A | 501-205 | Little Retractor, 7-1/2"                |
| B | 722-510 | Love Nerve Retractor, Straight, 8-1/2"  |
| C | 722-515 | Love Nerve Retractor, 45° Angle, 8-1/2" |
| D | 501-353 | Goelet Retractor, 7-1/2"                |
| E | 501-403 | U.S.A. Retractor, Set of 2, 8-1/2"      |



501-437



501-452



501-502



501-551

### RETRACTORS

- 501-437 RAGNELL Retractor, 6" (15.2 cm)
- 501-452 CRILE Retractor, 4-1/2", (11.4 cm)
- 501-502 LAHEY Retractor, 7-3/4" (19.7 cm)
- 501-551 GREEN Retractor, 8-1/2" (21.6 cm)
- 501-710 RICHARDSON Retractor, 9-1/2" (24.1 cm),  
Loop Handle, 1" (2.5 cm) X 3/4" (1.9 cm)
- 501-712 RICHARDSON Retractor, 9-1/2" (24.1 cm),  
Loop Handle, 1-1/4" (3.2 cm) X 1" (2.5 cm)
- 501-714 RICHARDSON Retractor, 9-1/2" (24.1 cm),  
Loop Handle, 1-1/2" (3.8 cm) X 1-1/2" (3.8 cm)
- 501-716 RICHARDSON Retractor, 9-1/2" (24.1 cm),  
Loop Handle, 2" (5.1 cm) X 3/4" (1.9 cm)



501-712



501-714



501-716



501-710

RICHARDSON



## RETRACTORS

- 501-575 DAVIS Retractors, Double Ended, 5-1/2" (14.0 cm)
- 501-601 PARKER Retractor, double end, set of 2
- 501-650 PARKER Retractor, 7-1/4" (18.4 cm), double end, set of 2
- 501-700 FARABEUF Retractor, 6" (15.2 cm), double end, set of 2
- 501-702 Baby FARABEUF Retractor, 4-3/4" (12.1 cm), D/E, set of 2
- 501-759 RICHARDSON Retractor, 9-1/2" (24.1 cm), grip handle, 1" (2.5 cm) X 3/4" (1.9 cm)
- 501-767 RICHARDSON Retractor, 9-1/2" (24.1 cm), grip handle, 1-1/2" (3.8 cm) X 1" (2.5 cm)
- 501-775 RICHARDSON Retractor, 9-1/2" (24.1 cm), grip handle, 1-1/2" (3.8 cm) X 1-1/2" (2.5 cm)
- 501-809 RICHARDSON Retractor, 9-1/2" (24.1 cm), grip handle, 2" (5.1 cm) X 3/4" (1.9 cm)
- 501-908 RICHARDSON-EASTMAN Retractor, double end, set of 2
- Small, 3/4" wide x 1-1/8" deep and 1-1/8" wide x 1-1/2" deep, length, 9-1/2"
  - Large, 1-5/8" wide x 2-1/2" deep and 1-1/2" wide x 1-3/4" deep, length 10-1/4"

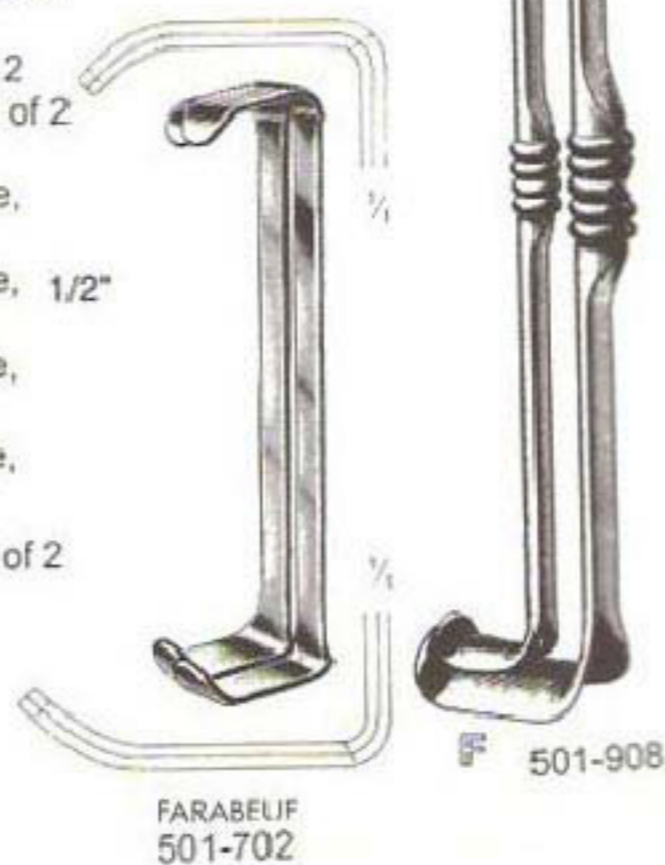

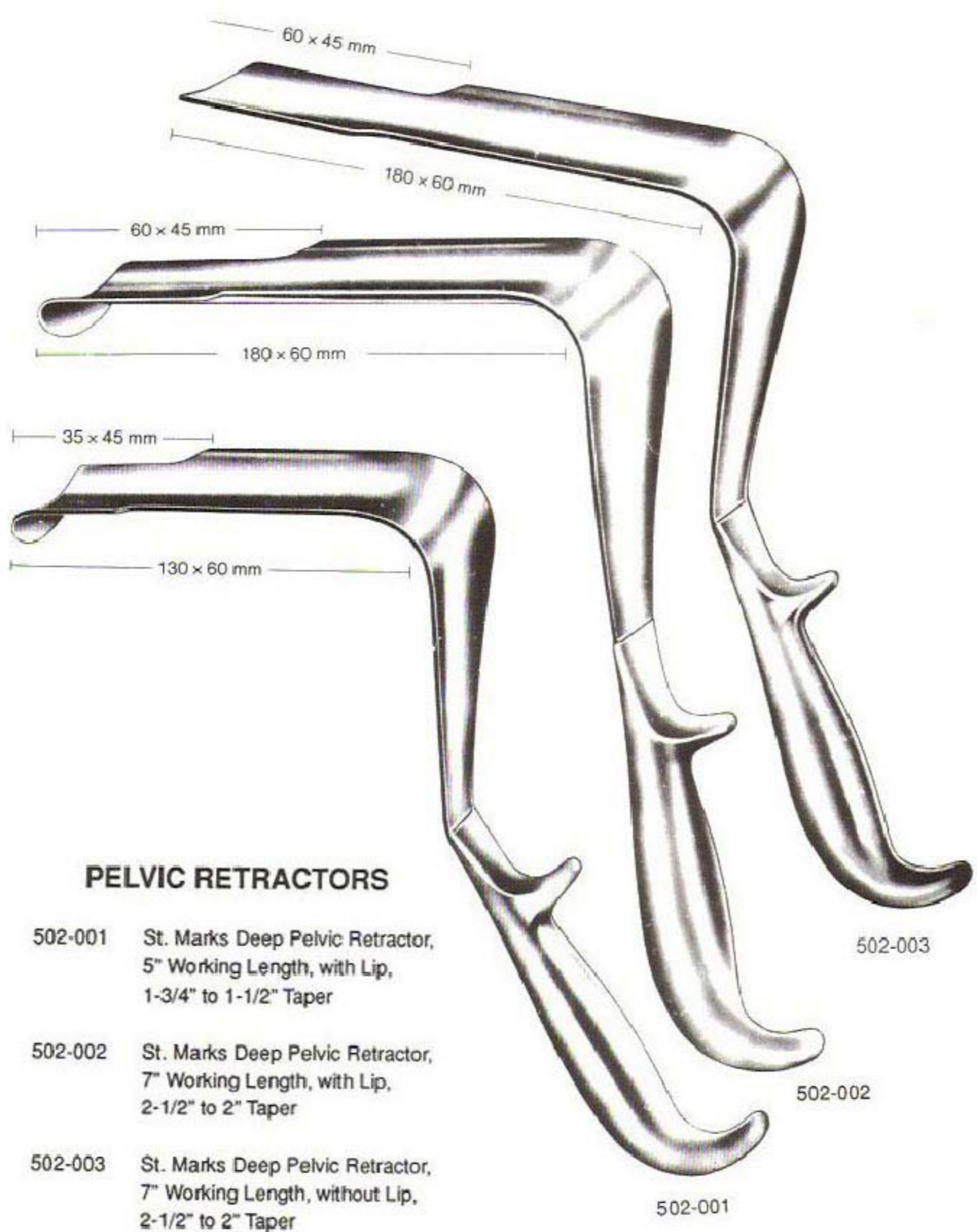

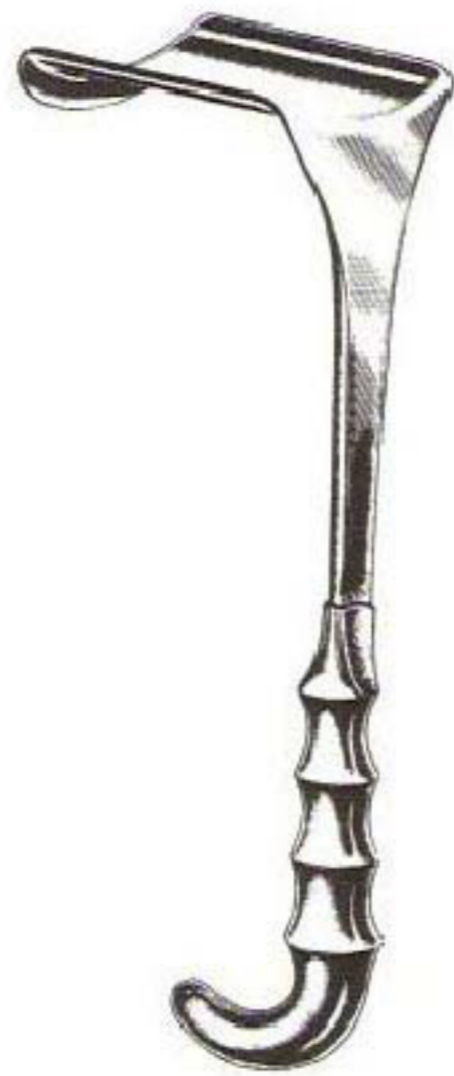

A



B

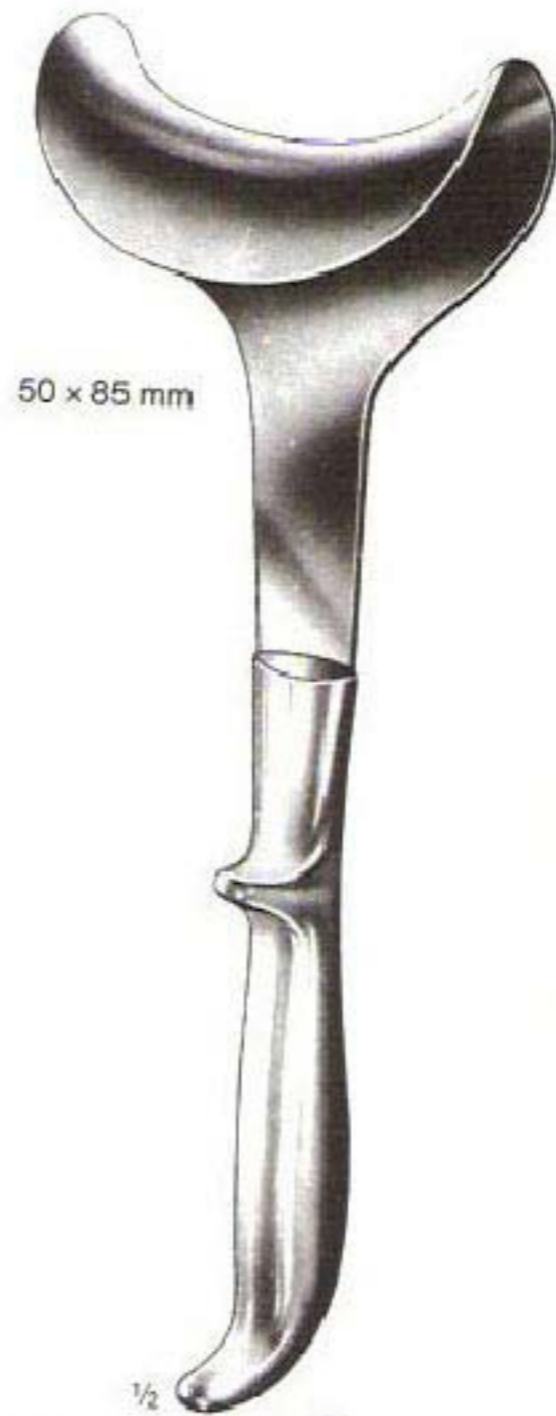

50 x 85 mm

$\frac{1}{2}$   
Doyen D

## RETRACTORS

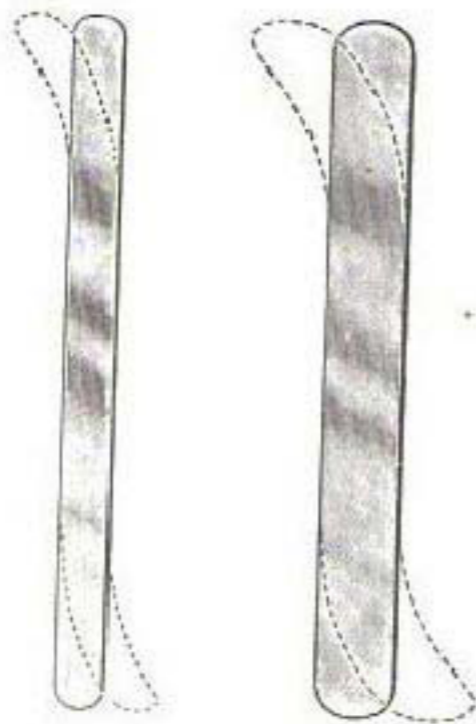

C

- |   |         |  |
|---|---------|--|
| A | 502-005 | KELLY Retractor, 9-1/2" (24.1 cm), Small, 1-1/2"x2"        |
|   | 502-013 | KELLY Retractor, 10" (25.4 cm), Medium, 2"x2-1/2"          |
|   | 502-021 | KELLY Retractor, 10" (25.4 M), Large, 2-1/2"x3"            |
|   | 502-039 | KELLY Retractor, 10" (25.4 cm), Extra Large, 3"x3-1/2"     |
| B | 502-104 | WEINBERG Vagotomy Retractor, blade 4" wide and 6-3/4" long |
| C | 502-194 | Pediatric Ribbon Retractor, 5/8" (1.6 cm) X 8" (20.3 cm)   |
|   | 502-198 | Pediatric Ribbon Retractor, 1" (2.5 cm) X 8" (20.3 cm)     |
|   | 502-203 | Ribbon Retractor, 3/4" (1.9 cm) X 13" (33 cm)              |
|   | 502-252 | Ribbon Retractor, 1" (2.5 cm) X 13" (33 cm)                |
|   | 502-278 | Ribbon Retractor, 1-1/4" (3.2 cm) X 13" (33 cm)            |
|   | 502-302 | Ribbon Retractor, 1-1/2" (3.8 cm) X 13" (33 cm)            |
|   | 502-351 | Ribbon Retractor, 2" (5.1 cm) X 13" (33 cm)                |
| D | 502-355 | DOYEN Retractor, 50 x 85mm, 25 cm Long                     |



### RETRACTORS

- A** 502-401 HARRINGTON Retractor, 12" (30.5 cm), blade 1-1/2" (3.8 cm) wide
- 502-450 HARRINGTON Retractor, 12" (30.5 cm), blade 2-1/2" (6.4 cm) wide
- 502-452 HARRINGTON Retractor, 9-1/2" (24.1 cm), blade 1" (2.5 cm) wide
- B** 502-583 Pediatric DEEVER Retractor, 5/8" (1.6 cm) X 8-1/2" (21.6 cm)
- 502-591 Pediatric DEEVER Retractor, 3/4" (1.9 cm) X 7" (17.8 cm)
- 502-609 Pediatric DEEVER Retractor, 7/8" (2.2 cm) X 8" (20.3 cm)
- 502-617 DEEVER Retractor, 1" (2.5 cm) X 9" (22.9 cm)
- 502-625 DEEVER Retractor, 1" (2.5 cm) X 10" (25.4 cm)
- 502-633 DEEVER Retractor, 1" (2.5 cm) X 12" (30.5 cm)
- 502-641 DEEVER Retractor, 1" (2.5 cm) X 14" (35.5 cm)
- 502-658 DEEVER Retractor, 1-1/2" (3.8 cm) X 12" (30.5 cm)
- 502-666 DEEVER Retractor, 2" (5.1 cm) X 12" (30.5 cm)
- 502-674 DEEVER Retractor, 3" (7.6 cm) X 12" (30.5 cm)
- 502-676 DEEVER Retractor with Hollow Grip handle, 2" (5.1 cm) X 12" (30.5 cm)
- 502-677 DEEVER Retractor with Hollow Grip handle, 3" (7.6 cm) X 12" (30.5 cm)
- 502-678 DEEVER Retractor with Hollow Grip handle, 4" (10.2 cm) X 12" (30.5 cm)



502-757  
502-807



502-856



502-906



502-968  
502-971  
502-989

502-955

## RETRACTORS

- 502-757 Bennett Tibia Retractor, Small, 9-1/2"
- 502-807 Bennett Tibia Retractor, Large, 9-1/2"

- 502-856 Hibbs Retractor, Set of 2, 3/4" x 2, 3-1/4" x 2-1/2", 9-1/2"
- 502-906 Hibbs Retractor, 3" x 1", 9-1/2"

- 502-955 Kocher Retractor, 1-1/2", 8-1/2"

- 502-968 Doyen Vaginal Retractor 9", Blade 1 3/4" x 2 1/2"
- 502-971 Doyen Vaginal Retractor 9", Blade 2 1/8" x 3"
- 502-989 Doyen Vaginal Retractor 9", Blade 2 1/2" x 3 1/2"

- 503-003 Meyerding Laminectomy Retractor, 9 1/2", Small Blade, 2" x 5/8"
- 503-052 Meyerding Laminectomy Retractor, 9 1/2", Medium Blade, 3" x 1"
- 503-102 Meyerding Laminectomy Retractor, 9 1/2", Large Blade, 3 1/2" x 2"

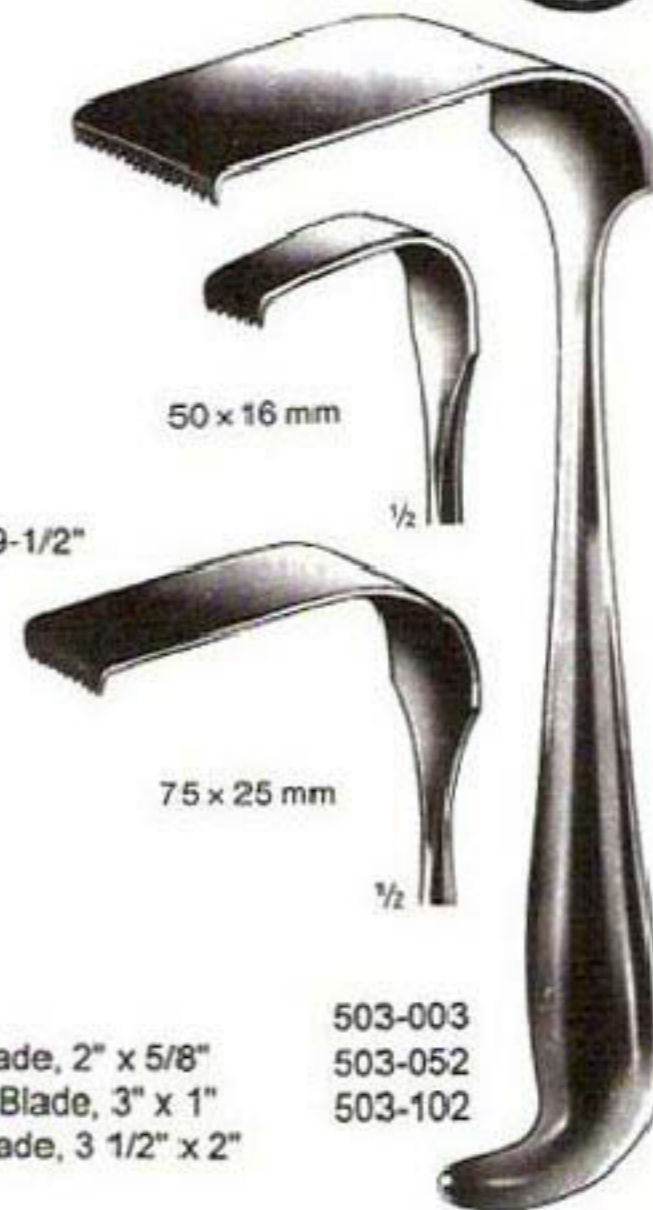

50 x 16 mm

1/2

75 x 25 mm

1/2

503-003  
503-052  
503-102



## RETRACTORS

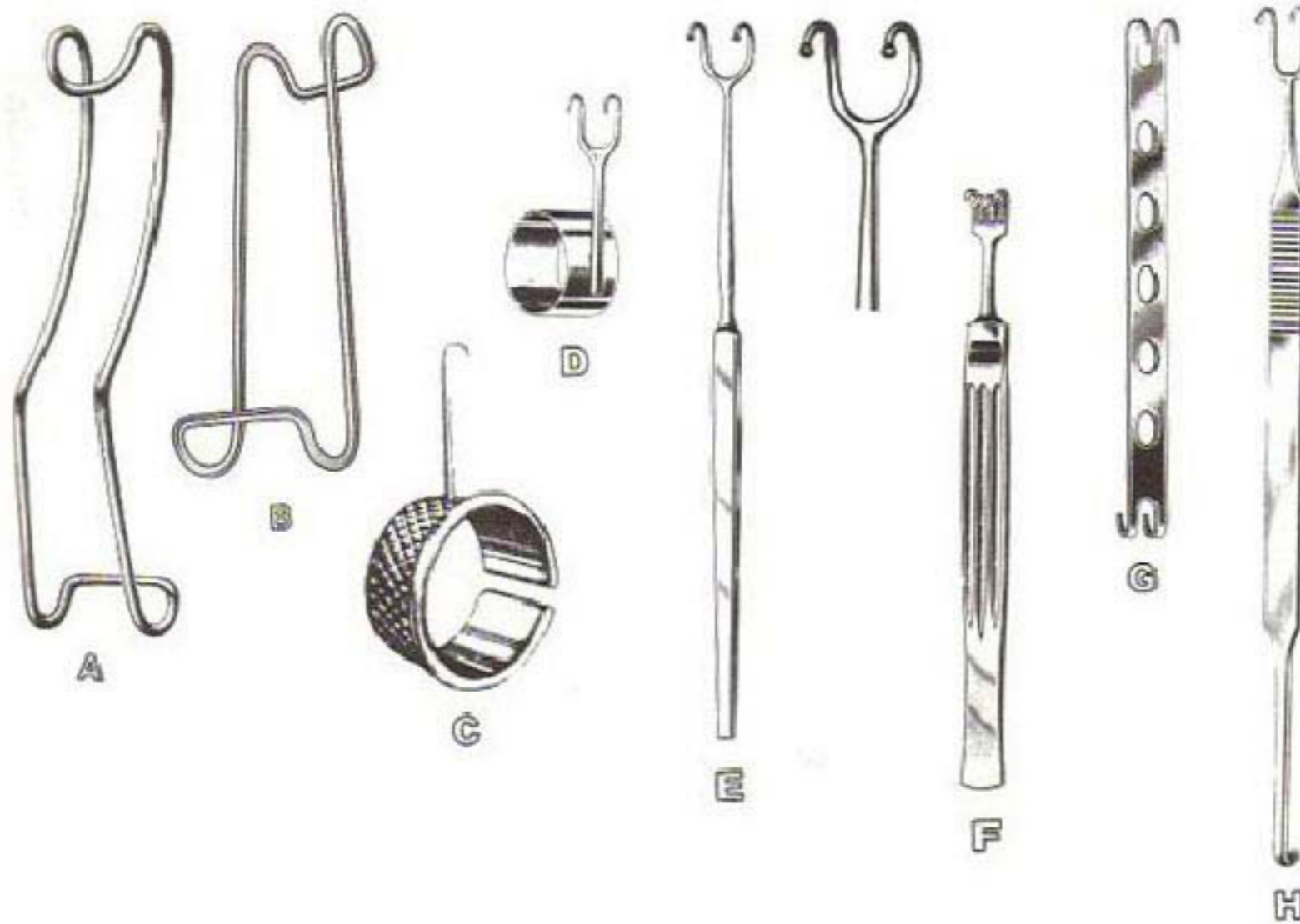

- A** 503-200 Fine Lip Retractor 6" (15.2 cm), Double End  
25mm and 36mm wide
- B** 503-205 Columbia Lip Retractor, 5 ½" (14cm) Double End  
37mm and 50mm wide
- C** 503-210 Millard Thimble Retractor, 5/8" (1.6cm) working Length  
Sharp, Single Hook
- D** 503-215 Cottle Thumb Retractor, 1 ½" (3.8 cm) working Length  
Sharp Double Hook 8mm wide
- E** 823-104 Foman Retractor 6 ½" (16.5 cm) Two Ball End Prongs 11mm wide
- F** 823-203 Cottle Retractor 5 ½" (14 cm), Four Blunt Prongs  
2 Center Prongs Recessed
- G** 503-230 Converse Alar Retractor 4" (10.2 cm) Double End  
w/Blunt Double Hooks 10mm and 14mm wide
- H** 503-235 Cottle Knife Guide and Retractor 8" (20.3 cm) Double End  
Ball Tip Prongs, 10mm Wide, and 5mm Wide Slotted Hook





## RETRACTORS

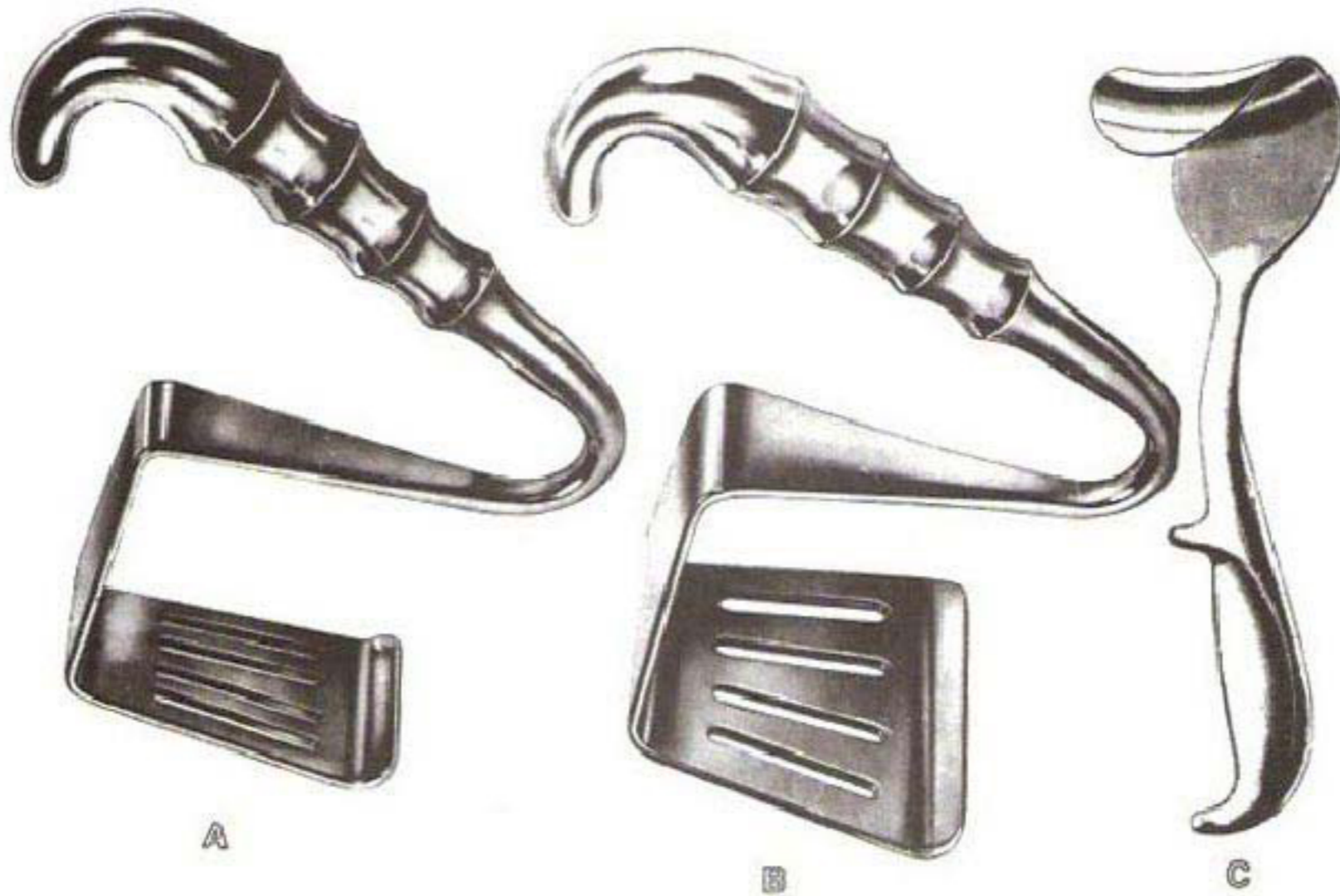

- A 503-240 Davidson (Scapula) Retractor 75 x 50mm
- B 503-245 Davidson (Scapula) Retractor 75 x 90mm

- C 503-250 Mayo Abdominal Retractor, 2 3/4" Blade

- D 503-255 DeLee Universal Retractor, 9 1/2" Blade 2 1/4" x 2"





## RETRACTORS

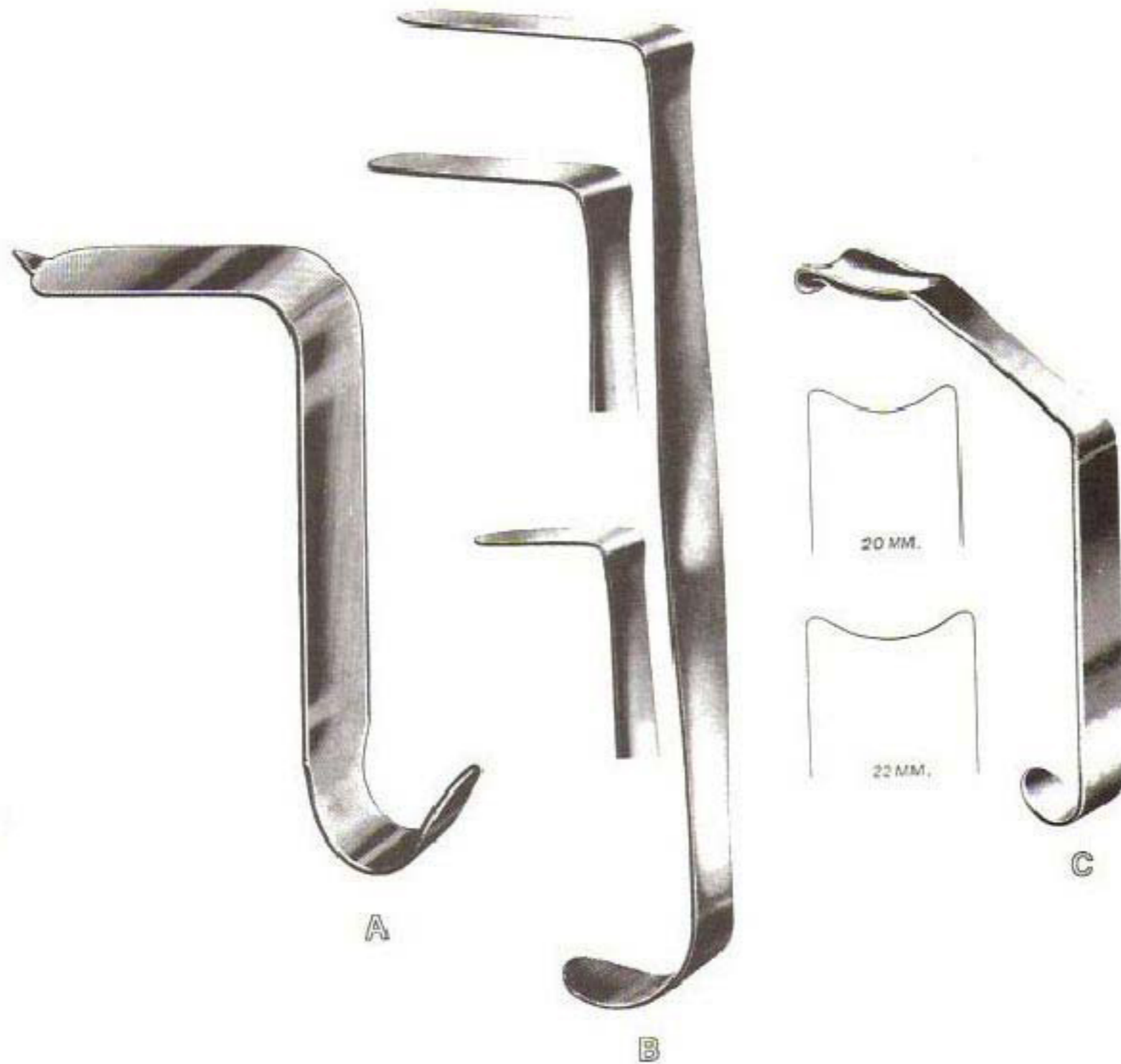

- |   |         |  |
|---|---------|--|
| A | 503-260 | Taylor Spinal Retractor, 7 1/4", Blade 1 1/4" x 3" |
|   | 503-262 | Taylor Spinal Retractor, 8", Blade 1 1/4" x 4"     |
| B | 921-502 | Heaney Retractor 10 1/2", Blade 1 1/8" x 1 3/4"    |
|   | 921-510 | Heaney Retractor 10 1/2", Blade 1 1/8" x 2 7/8"    |
|   | 921-528 | Heaney Retractor 10 1/2", Blade 1 1/8" x 3 1/4"    |
| C | 844-381 | Love Uvula Retractor, 18mm Wide Blade              |
|   | 844-407 | Love Uvula Retractor, 20mm Wide Blade              |
|   | 844-423 | Love Uvula Retractor, 22mm Wide Blade              |



## RETRACTORS

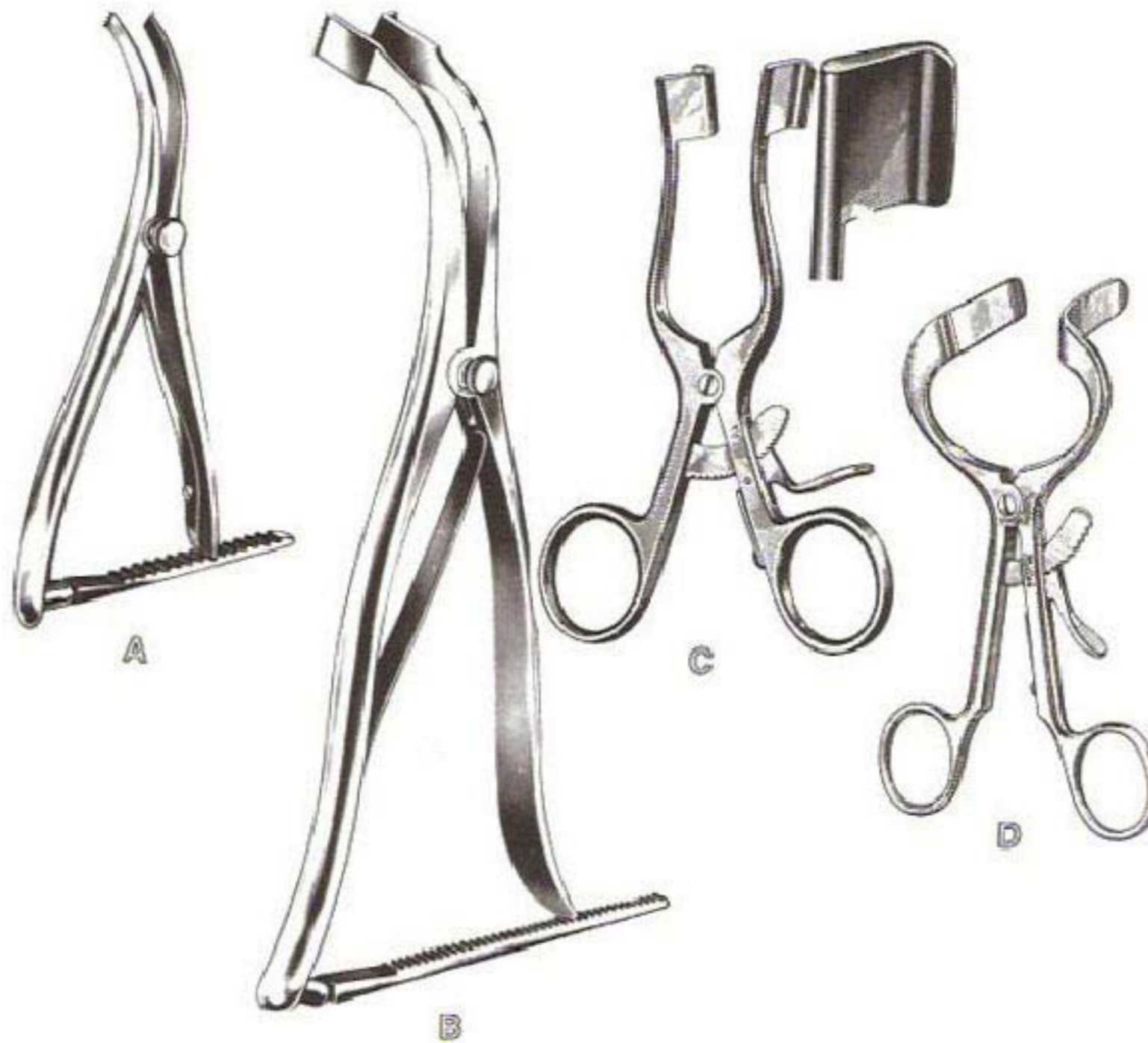

- A** 503-276 Inge Lamina Spreader 6", Jaws Open To 1 1/8"
- 503-278 Inge Lamina Spreader 6", Jaws Open To 1 1/8", w/out Teeth
- B** 503-280 Inge Lamina Spreader 9 1/2", Jaws Open To 1 3/4", Smooth Handles
- C** 503-282 Weitlaner Retractor 5 1/2", Solid Blades
- D** 503-284 Schink Metatarsal Spreader, 4 1/2"



## RETRACTORS



- |          |                |  |
|----------|----------------|--|
| <b>A</b> | <b>510-100</b> | <b>Mini-Hohmann Retractor 6 ¼" (15.9cm)</b><br><b>Blade 6mm wide</b> |
|          | <b>510-105</b> | <b>Mini-Hohmann Retractor 6 ¼" (15.9cm)</b><br><b>Blade 8mm wide</b> |
| <b>B</b> | <b>510-110</b> | <b>Hohmann Retractor 9 ¼" (23.5cm)</b><br><b>Blade 10mm wide</b>     |
|          | <b>510-115</b> | <b>Hohmann Retractor 9 ¼" (23.5cm)</b><br><b>Blade 18mm wide</b>     |
| <b>C</b> | <b>510-120</b> | <b>Hohmann Retractor 9 ¼" (23.5cm)</b><br><b>Blade 25mm wide</b>     |
|          | <b>510-125</b> | <b>Hohmann Retractor 9 ¼" (23.5cm)</b><br><b>Blade 43mm wide</b>     |
| <b>D</b> | <b>510-130</b> | <b>Hohmann Retractor 9 ¼" (23.5cm)</b><br><b>Blade 70mm wide</b>     |

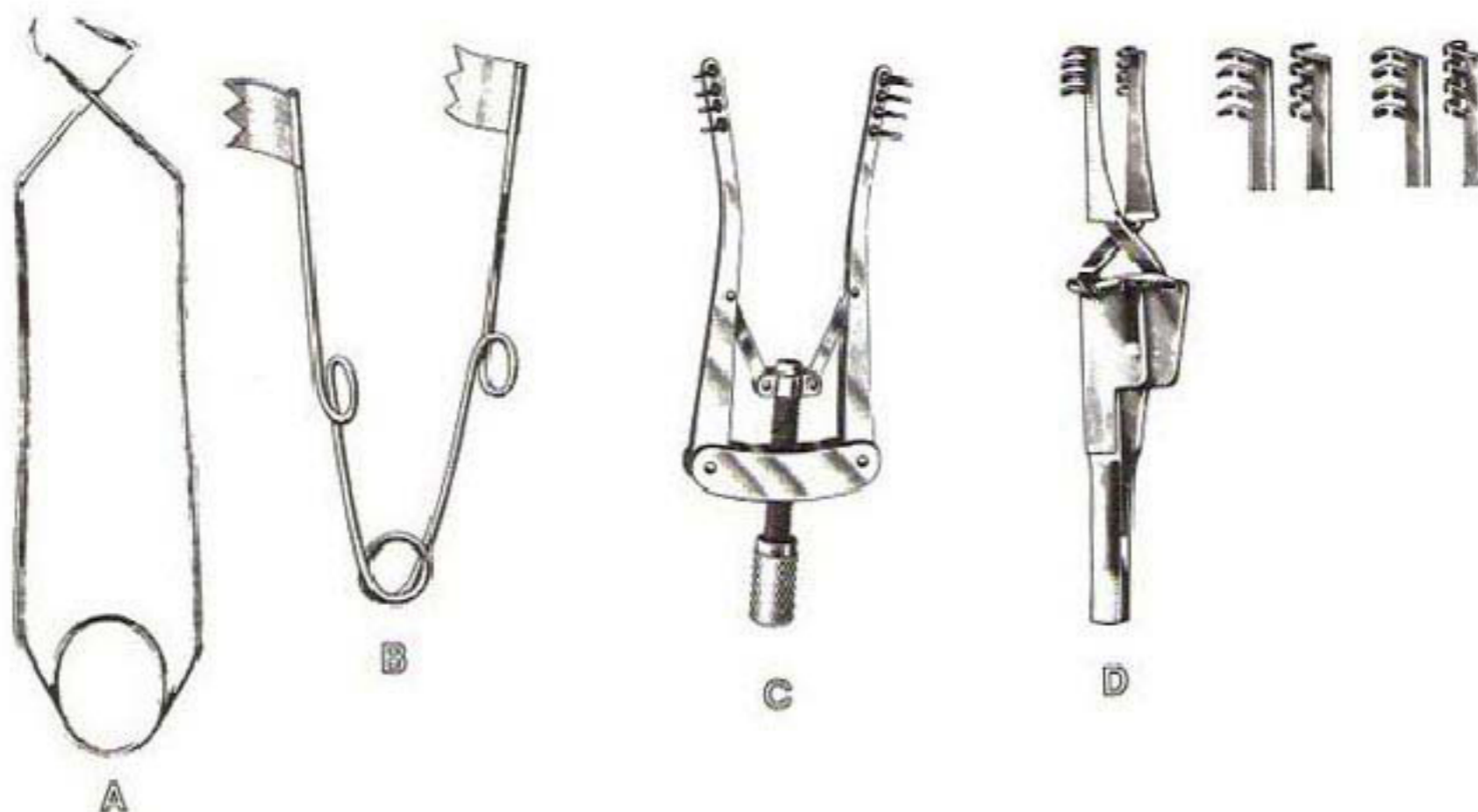

### SELF-RETAINING RETRACTORS

- |          |         |  |
|----------|---------|--|
| <b>A</b> | 520-015 | Farr Automatic Wire Retractor, #1, 5-1/2" x 3/4", Single Prong, 3-1/2" |
|          | 520-023 | Farr Automatic Wire Retractor, #2, 5-1/2" x 1-1/8", Single Prong, 4"   |
| <b>B</b> | 520-014 | Spring Wire Retractor with Flag, 10mm x 13mm Deep                      |
| <b>C</b> | 520-056 | Alm Minor Surgery Retractor, with 4mm Prongs, 2-3/4"                   |
|          | 520-106 | Alm Minor Surgery Retractor, with 9mm Prongs, 4"                       |
| <b>D</b> | 520-155 | Automatic Skin Retractor, 5mm, Sharp Teeth, 4"                         |
|          | 520-160 | Automatic Skin Retractor, Blunt Teeth, 4 Prongs                        |
| <b>E</b> | 520-247 | Weitlaner Retractor, 2 x 3 Prongs, Sharp, 4"                           |
|          | 520-346 | Weitlaner Retractor, 2 x 3 Prongs, Blunt, 4"                           |
| <b>F</b> | 520-254 | Weitlaner Retractor, 3x4 Prongs, Sharp, 5 1/2"                         |
|          | 520-353 | Weitlaner Retractor, 3x4 Prongs, Blunt, 5 1/2"                         |
|          | 520-262 | Weitlaner Retractor, 3x4 Prongs, Sharp, 6 1/2"                         |
|          | 520-361 | Weitlaner Retractor, 3x4 Prongs, Blunt, 6 1/2"                         |
|          | 520-265 | Weitlaner Retractor, 3x4 Prongs, Sharp, 8"                             |
|          | 520-374 | Weitlaner Retractor, 3x4 Prongs, Blunt, 8"                             |
|          | 520-228 | Weitlaner Retractor, 3x4 Prongs, Sharp, 9 1/2"                         |
|          | 520-387 | Weitlaner Retractor, 3x4 Prongs, Blunt, 9 1/2"                         |

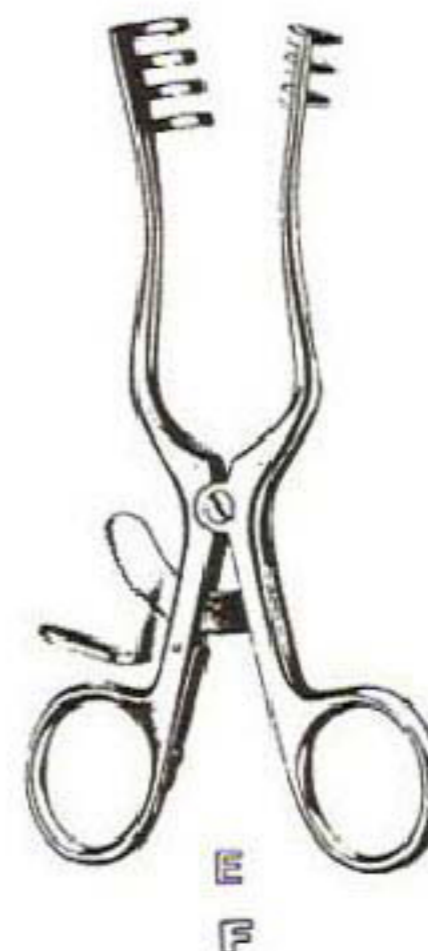



520-452  
520-460

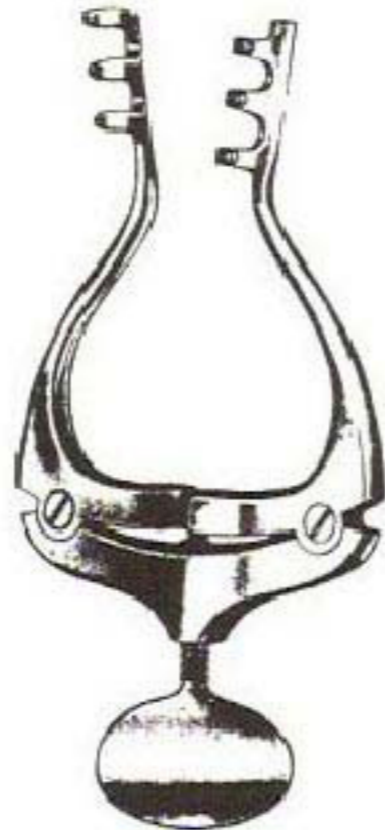

520-502



520-601  
520-650

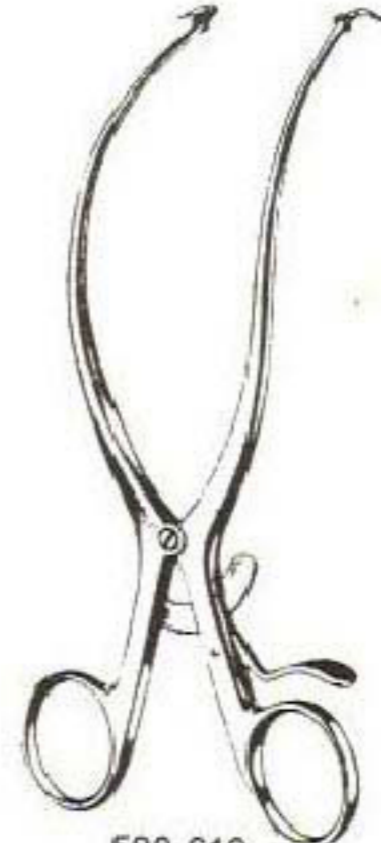

520-619

## SELF-RETAINING RETRACTORS

- 520-452 Weitlaner Retractor, Hinged Blades, 3 x 4 Prongs, Sharp, 6-1/2"  
520-460 Weitlaner Retractor, Hinged Blades, 3 x 4 Prongs, Blunt, 6-1/2"
- 520-502 Jansen Retractor, 3 x 3 Prongs, 10mm, 4-1/2", Blunt
- 520-601 Gelpi Retractor 6 3/4", w/Grip Lock  
520-619 Gelpi Retractor 6 3/4", w/Ball Stops and Grip Lock  
520-650 Pediatric Gelpi Retractor 5 1/2" w/Grip Lock
- 520-700 Mayo Adams Abdominal Retractor, with Center Blade, 6-3/4"

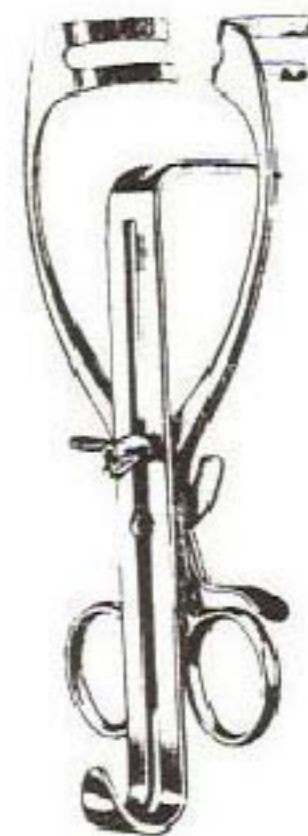

520-700

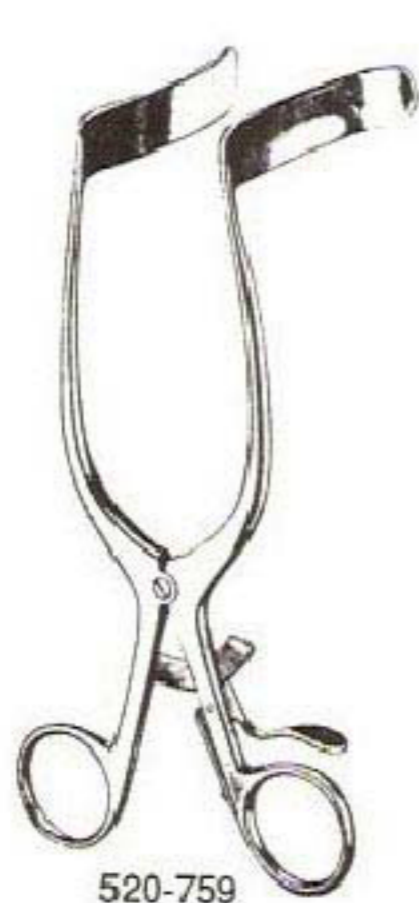

520-759

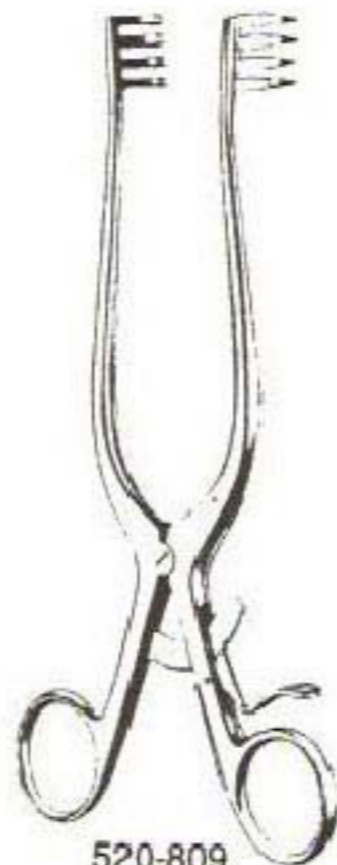

520-809  
520-810



520-858

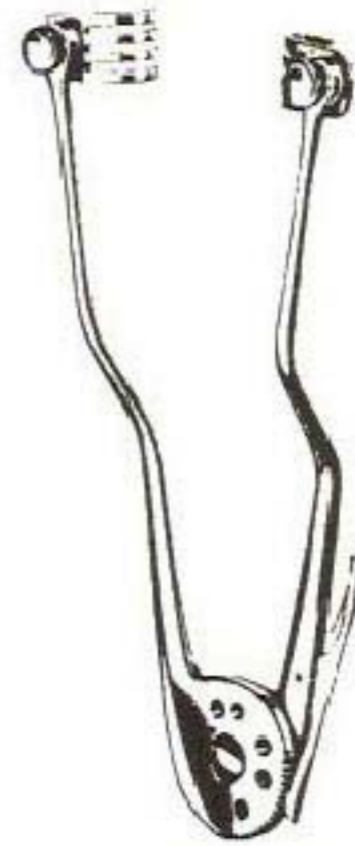

520-908

### SELF-RETAINING RETRACTORS

- 520-759 Rigby Appendectomy Retractor 6 3/4", w/Grip Lock
- 520-809 Adson Retractor 7 1/2" Sharp, 4x4 Teeth, 3/4" x 3/4" Straight Arms
- 520-810 Adson Retractor 7 1/2" Sharp, 4x4 Teeth, 3/4" x 3/4" Angled Arms
- 520-858 Beckman Retractor 12 1/2", Hinged, Sharp, 4x4 Teeth 3/4" x 1"
- 520-883 Adson Retractor 7 1/2" Angled Sharp, 4x4 Teeth 3/4" x 3/4"
- 520-908 Crotti Retractor 7 1/4" w/Swivel Blade, Sharp
- 520-957 Beckman-Adson Retractor 12 1/2", Hinged, Sharp, 3/4" x 1"



520-957



### SELF-RETAINING RETRACTORS

- 521-005 Balfour Abdominal Retractor, Improved Model with Ratchet Bar Assembly and Two Sets of Interchangeable Blades, 7" Spread (20cm), Side Blades are 2" (5cm) Wide and 3" (8cm) Deep, Center Blades are 1 3/4" (4cm) Wide and 2 5/8" (6.5cm) Deep, 2 3/4" (7cm) Wide and 3 1/4" (8.5cm) Deep.
- 521-100 BALFOUR Center Blade for Retractor, extra deep model, 2-3/4" (7 cm) X 4" (10.2 cm)
- 521-252 BALFOUR "Baby" Retractor, side blades are 1-1/8" (3 cm) deep, center blade measures 7/8" (2.2 cm) by 7/8" (2.2 cm), maximum opening is 3-1/4" (8.5 cm)





## BALFOUR ABDOMINAL RETRACTORS

BALFOUR Retractors, standard models with 7" (20 cm) maximum opening, side blades are 2-1/2" (6.3 cm) deep and center blade measures 2" (5.1 cm) deep and 3" (8 cm) wide.

- |   |         |   |
|---|---------|---|
| A | 521-302 | Balfour Abdominal Retractor with solid side blades, 3" (7.6 cm) wide x 2" (5.1 cm) deep, 7" spread                            |
|   | 521-351 | Balfour Abdominal Retractor with fenestrated side blades, 3" (7.6 cm) wide x 4" (10.2 cm) extra deep center blades, 7" spread |
| B | 521-376 | Balfour Abdominal Retractor with fenestrated side blades, 3" (7.6 cm) wide x 2" (5.1 cm) deep center blades, 7" spread        |
| C | 521-380 | Balfour Abdominal Retractor with fenestrated side blades, 3" (7.6 cm) wide x 2" (5.1 cm) deep center blades, 10" spread       |
|   |         | <b>BALFOUR Center Blades</b>  |
| D | 521-401 | 3" (7.6 cm) wide x 2" (5.1 cm) deep   |
|   | 521-419 | 3" (7.6 cm) wide x 4" (10.2 cm) extra deep  |
|   | 521-427 | 2" (5.1 cm) wide x 5" (12.7 cm) deep malleable  |



- 521-757 O'SULLIVAN-O'CONNOR Abdominal Retractor, with 7" (18 cm) maximum opening, two small blades, measuring 1 3/4" (4.5 cm) x 2 1/2" (6.3cm) one large blade, 2 3/4" (7 cm) x 4" (10 cm), are furnished.
- 521-760 Gosset Retractor, 4" Spread, 1" x 1 1/2" Blades  
521-762 Gosset Retractor, 5 1/2" Spread, 1" x 2 1/2" Blades



## PROBES and GROOVED DIRECTORS

540-450	Probe with Eye, 4-1/2", stainless	542-001	Probe, D/E, Spear, stainless, 4-1/2"
540-500	Probe with Eye, 5", stainless	542-019	Probe, D/E, Spear, stainless, 5"
540-609	Probe with Eye, 6", stainless	542-027	Probe, D/E, Spear, Stainless, 5-1/2"
540-807	Probe with Eye, 8", stainless	542-035	Probe, D/E, Spear, Stainless, 6"
540-809	Probe with Eye, 10", stainless	542-550	Probe with Myrtle Leaf, 5"
541-458	Probe, D/E, stainless, 4-1/2"	543-454	Grooved Director, with Tongue Tie, 4-1/2"
541-508	Probe, D/E, stainless, 5"	543-504	Grooved Director, with Tongue Tie, 5"
541-557	Probe, D/E, stainless, 5-1/2"	543-553	Grooved Director, with Tongue Tie, 5-1/2"
541-607	Probe, D/E, stainless, 6"	543-603	Grooved Director, with Tongue Tie, 6"
541-805	Probe, D/E, stainless, 8"	543-801	Grooved Director, with Tongue Tie, 8"
541-807	Probe, D/E, Stainless, 10"		
544-452	Grooved Director, with Probe tip and Tongue Tie, 4-1/2"		
544-502	Grooved Director, with Probe tip and Tongue Tie, 5"		
544-551	Grooved Director, with Probe tip and Tongue Tie, 5-1/2"		
544-601	Grooved Director, with Probe tip and Tongue Tie, 6"		
544-809	Grooved Director, with Probe tip and Tongue Tie, 8"		



### NABATOFF VAIN STRIPPER SET

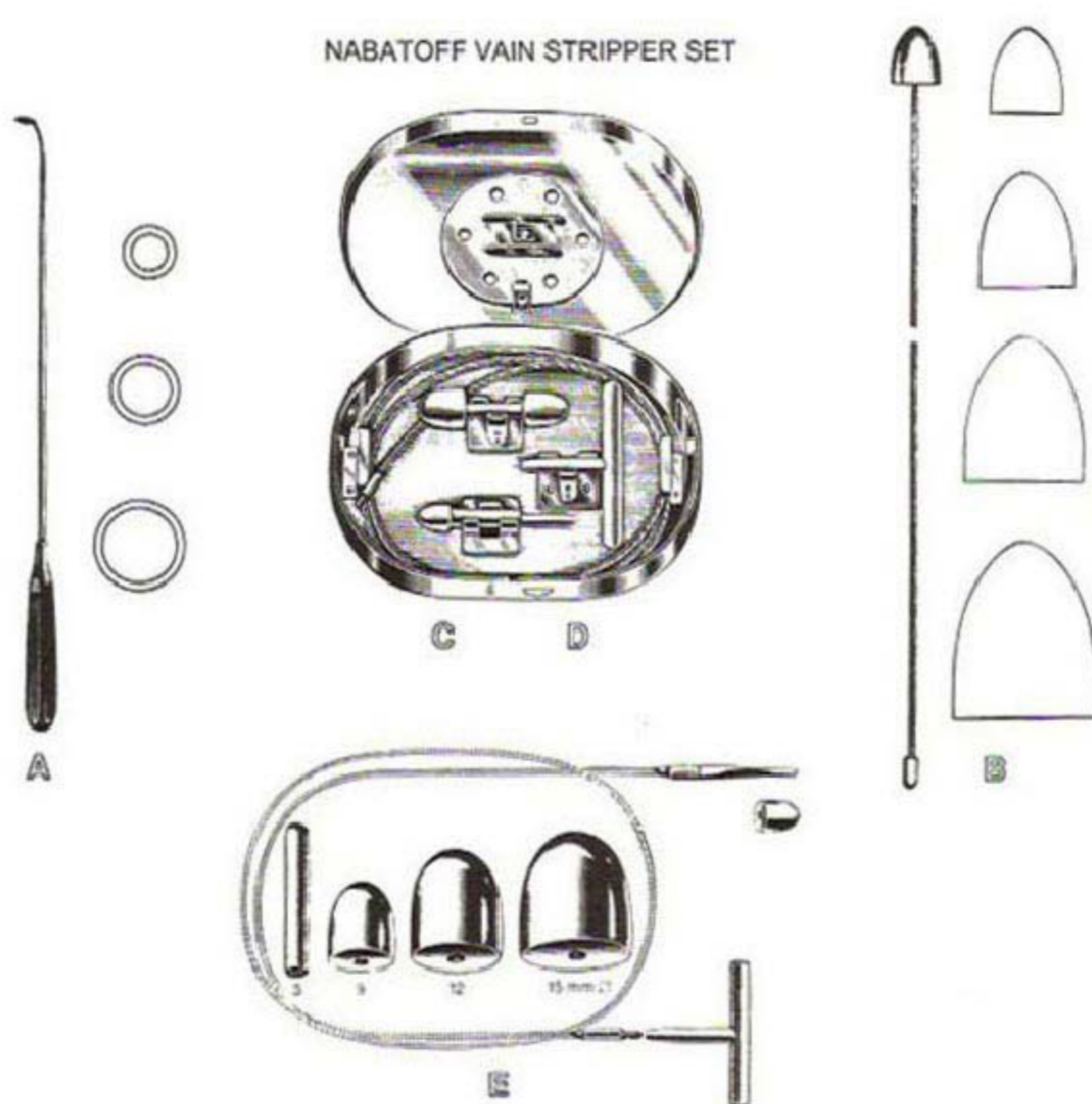

### VEIN STRIPPERS

- |  |  |
|--|--|
| <p><b>A</b> Mayo External Vein Stripper, 15" (38 cm).<br/>Sizes are inside diameter</p> <p>545-004 Mayo Vein Stripper, 3/16"<br/>545-053 Mayo Vein Stripper, 9-32"<br/>545-103 Mayo Vein Stripper, 3/8"</p> <p><b>B</b> Meyer Vein Stripper, flexible cable shaft</p> <p>545-251 Meyer Vein Stripper, 3/8"<br/>545-301 Meyer Vein Stripper, 1/2"<br/>545-350 Meyer Vein Stripper, 5/8"<br/>545-400 Meyer Vein Stripper, 3/4"</p> | <p><b>C</b> 545-509 Meyer Vein Stripper, Handle Only</p> <p><b>D</b> 546-002 Nabatoff Vein Stripper Set,<br/>complete in sterilizable case,<br/>including 3 olives (9mm, 12mm and<br/>15mm), 2 probe tips, handle and 36"<br/>(90 cm) cable.</p> <p><b>E</b> 546-200 Nabatoff Sterilizer Case Only</p> |
|--|--|

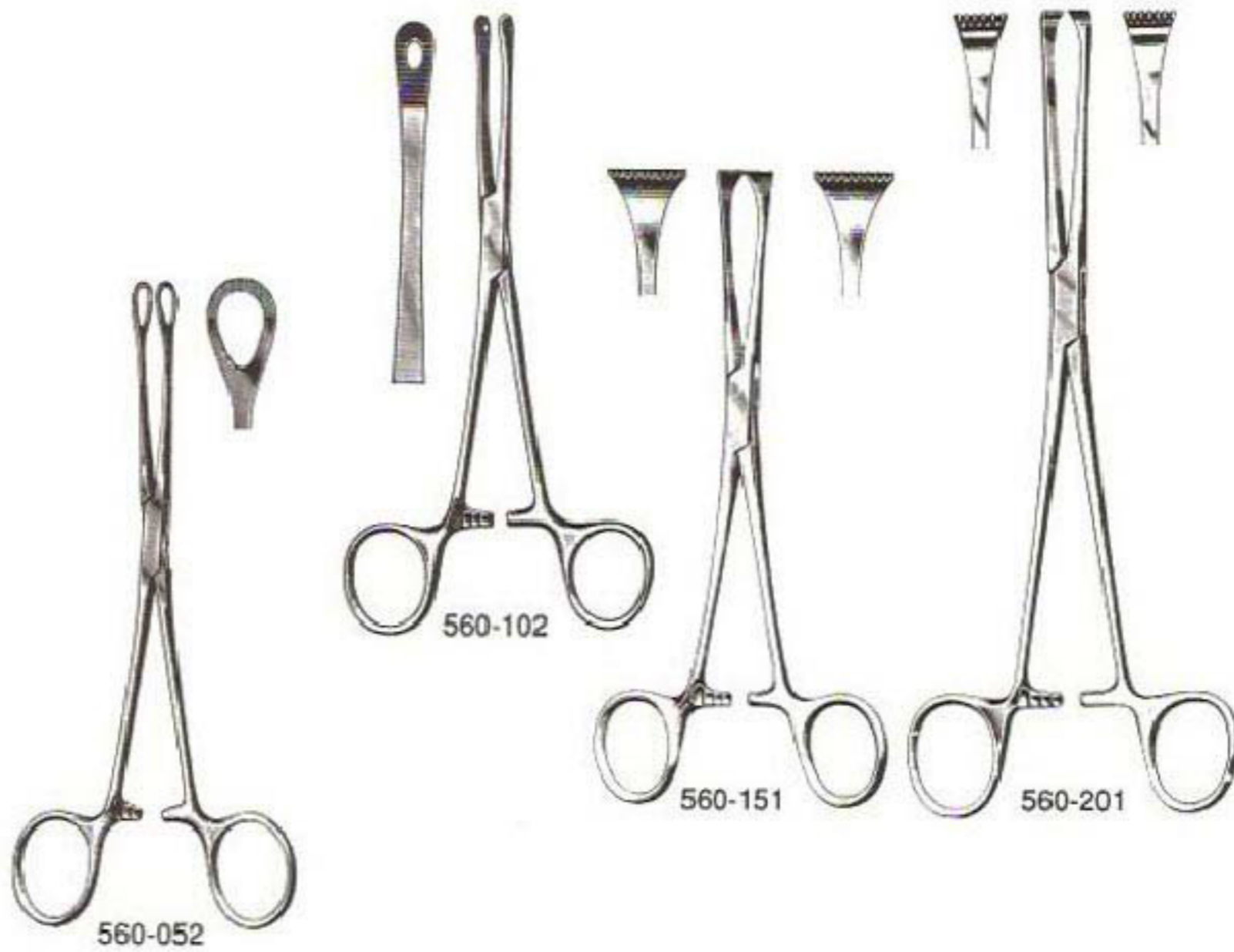

## INTESTINAL and TISSUE FORCEPS

560-052 Williams Tissue Forceps, 6-1/2"

560-102 Percy Tissue Forceps, 6"

560-151 Allis-Adair Tissue Forceps, 9 x 10 Teeth, 6"

560-201 Thoms-Allis Tissue Forceps, 6 x 7 Teeth, 8"



### INTESTINAL and TISSUE FORCEPS

- 560-225 Judd-Allis Tissue Forceps, 6"
- 560-250 Judd-Allis Tissue Forceps, 7-1/2"
- 560-557 Allis Tissue Forceps, 3 x 4 Teeth, 5-1/2"
- 560-582 Allis Tissue Forceps, 4 x 5 Teeth, Pediatric, 5-1/2"
- 560-607 Allis Tissue Forceps, 4 x 5 Teeth, 6"
- 560-615 Allis Tissue Forceps, 5 x 6 Teeth, 6"
- 560-755 Allis Tissue Forceps, 5 x 6 Teeth, 7-1/2"

561-068  
561-076

- 561-001 Allis Willauer Tissue Forceps, 10"
- 561-068 Allis Tissue Forceps, 6" w/Double Row of Non-Traumatic Teeth
- 561-076 Allis Tissue Forceps, 7 1/4" w/Double Row of Non-Traumatic Teeth

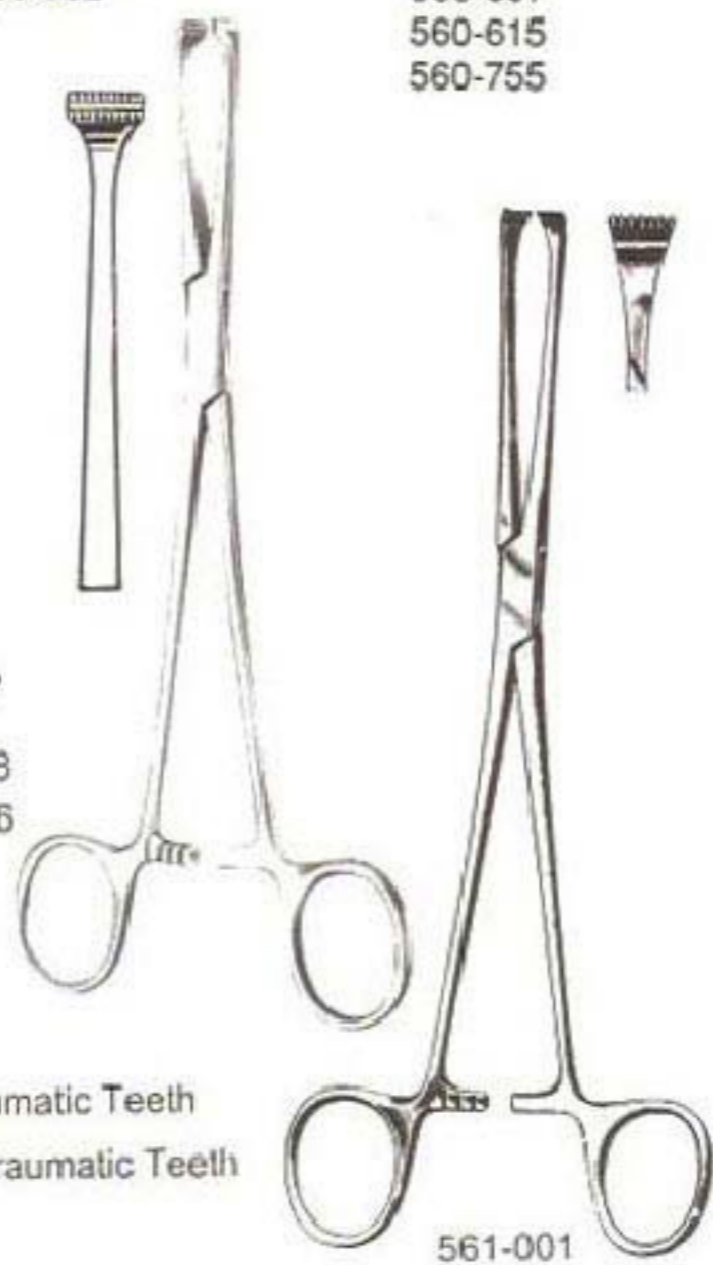



## INTESTINAL and TISSUE FORCEPS

561-555	Babcock Intestinal Forceps, 5 ½"
561-654	Babcock Intestinal Forceps, 6 ¼"
561-753	Babcock Intestinal Forceps, 8 ¼"
561-951	Babcock Intestinal Forceps, 9 ½"
562-009	Scudder Intestinal Forceps, Straight, solid blades, 9 ½"
562-058	Scudder Intestinal Forceps, Straight, solid blades, 13"



## INTESTINAL and TISSUE FORCEPS

562-108	Kocher Intestinal Forceps 10 ½" Straight, Longitudinal Serrations
562-157	Kocher Intestinal Forceps 10 ½" Dble Curved, Longitudinal Serrations
562-207	Doyen Intestinal Forceps, 9" Straight, Flexible Blades w/Longitudinal Serrations
562-256	Doyen Intestinal Forceps, 9" Curved, Flexible Blades w/Longitudinal Serrations
562-260	Doyen Intestinal Forceps, 9" Straight, Diagonal Serrations
562-265	Doyen Intestinal Forceps, 9" Curved, Diagonal Serrations





## INTESTINAL and TISSUE FORCEPS

- |          |         |   |
|----------|---------|---|
| <b>A</b> | 562-501 | Child Intestinal Forceps 9 ¾" (24.8cm), with Interchangeable Rubber Jaws                  |
|          | 562-502 | Replacement Rubber Jaws for No. 562-501   |
| <b>B</b> | 562-504 | Collin Intestinal Forceps 8" (20.3cm) with ½" (1.3cm), wide Jaws                          |
|          | 562-508 | Collin Intestinal Forceps 8" (20.3cm) with 1" (2.5cm), wide Jaws                          |
| <b>C</b> | 661-002 | Collin-Duval Tissue Forceps 8" (20.3cm) with ½" (1.3cm), wide Jaws                        |
| <b>D</b> | 562-514 | Allen Intestinal Clamp 8" (20.3cm) Longitudinal Serrations with 1x2 Teeth                 |
|          | 562-516 | Baby Allen Intestinal Clamp 6 ½" (16.5cm) Delicate Longitudinal Serrations with 1x2 Teeth |
| <b>E</b> | 923-508 | Adair Tissue Tenaculum Forceps 6 ½" (16.5cm)  |



563-285



563-288



563-312



563-388

## INTESTINAL INSTRUMENTS

### PAYR PYLOROUS CLAMPS

563-285 Payr Pylorus Clamp, "Baby", 6"

563-288 Payr Pylorus Clamp, 8"

563-312 Payr Pylorus Clamp, 11"

563-388 Payr Pylorus Clamp, 13 3/4"



## GALL BLADDER INSTRUMENTS

- |         |   |
|---------|---|
| 600-056 | Ferguson Gall Stone, Scoop, Small, 8-1/2" |
| 600-106 | Ferguson Gall Stone Scoop, Medium, 8-1/2" |
| 600-155 | Ferguson Gall Stone Scoop, Large, 8-1/2"  |
| 600-171 | Desjardin Gall Stone Scoop, 17 Fr., 11"   |
| 600-213 | Desjardin Gall Stone Scoop, 21 Fr., 11"   |
| 600-247 | Desjardin Gall Stone Scoop, 24 Fr., 11"   |
| 600-270 | Desjardin Gall Stone Scoop, 27 Fr., 11"   |
| 600-304 | Mayo Cystic Duct Scoop, 10-1/2"           |
| 600-353 | Moore Gall Stone Scoop, 11"               |
| 600-403 | Mayo Gall Stone Scoop, 11"                |



600-452  
600-460  
600-478



600-502

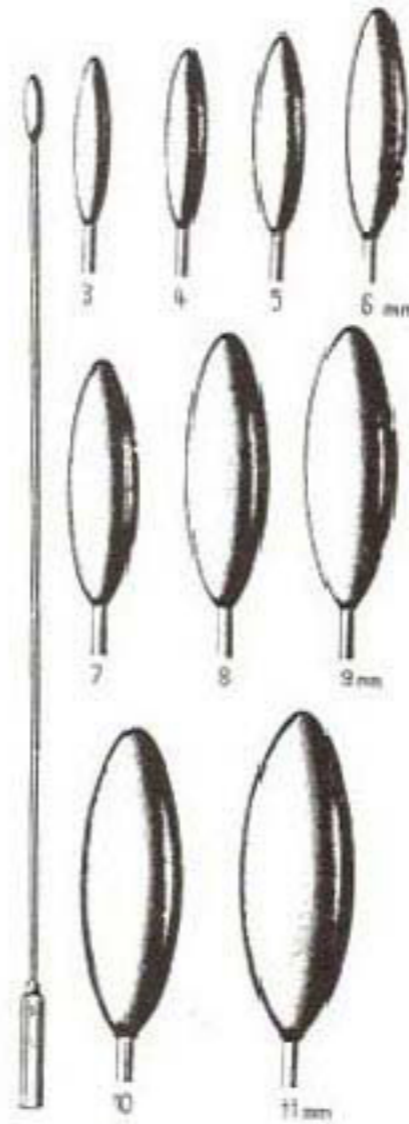

600-635  
through  
600-718



600-809  
600-858

## GALL BLADDER INSTRUMENTS

- 600-452 Mayo Common Duct Scoop, Small, Silver Plated, 10-1/2"
- 600-460 Mayo Common Duct Scoop, Medium, Silver Plated, 10-1/2"
- 600-478 Mayo Common Duct Scoop, Large, Silver Plated, 10-1/2"
- 600-502 Ochsner (Spiral) Gall Stone Probe, 14"
- 600-601 Bakes Common Duct Dilator, Set of 9, 8-1/2"
- 600-635 Bakes Common Duct Dilator, 3mm, 8-1/2"
- 600-643 Bakes Common Duct Dilator, 4mm, 8-1/2"
- 600-650 Bakes Common Duct Dilator, 5mm, 8-1/2"
- 600-668 Bakes Common Duct Dilator, 6mm, 8-1/2"
- 600-676 Bakes Common Duct Dilator, 7mm, 8-1/2"
- 600-684 Bakes Common Duct Dilator, 8mm, 8-1/2"
- 600-692 Bakes Common Duct Dilator, 9mm, 8-1/2"
- 600-700 Bakes Common Duct Dilator, 10mm, 8-1/2"
- 600-718 Bakes Common Duct Dilator, 11mm, 8-1/2"
- 600-809 Blake Gall Stone Forceps, Straight, 8-1/4"
- 600-858 Blake Gall Stone Forceps, Curved, 8-1/4"



600-908  
600-916  
600-924



600-957  
600-958



601-054

## GALL BLADDER INSTRUMENTS

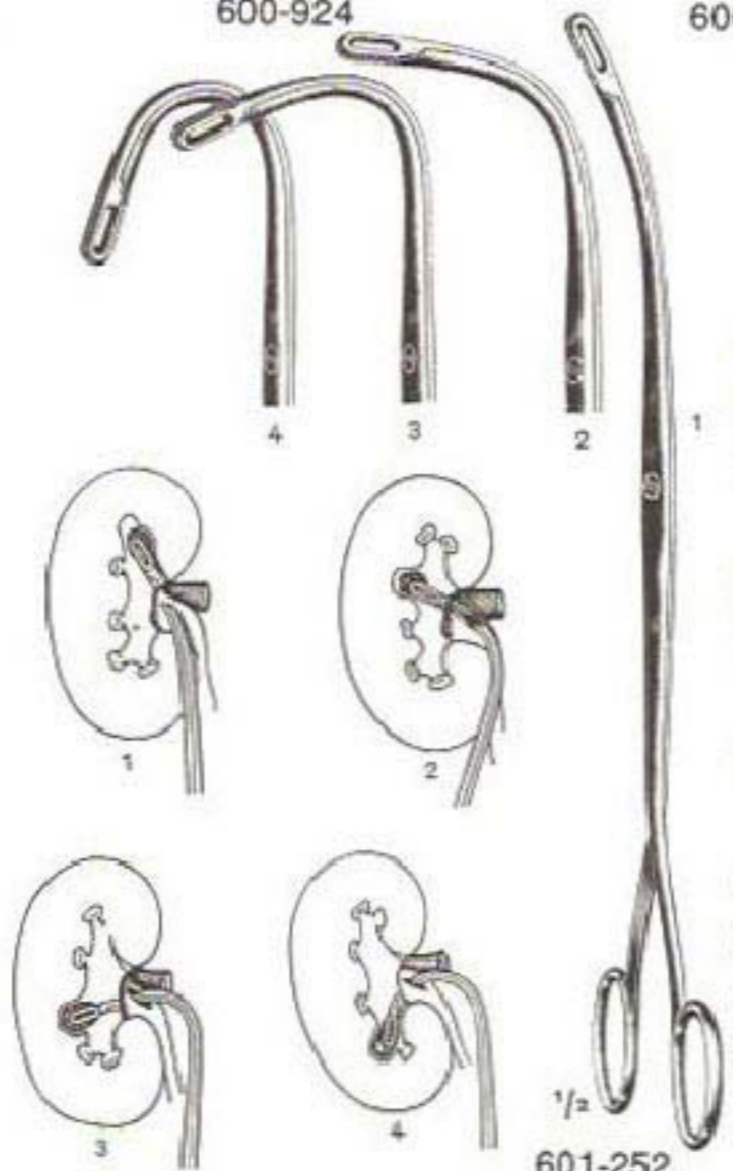

601-252  
through  
601-286

- 600-908 Desjardin Gall Duct Probe, 13 Fr., 11"
- 600-916 Desjardin Gall Duct Probe, 18 Fr., 11"
- 600-924 Desjardin Gall Duct Probe, 21 Fr., 11"
  
- 600-957 Desjardin Gall Stone Forceps, Fig. 1, 9"
- 600-958 Desjardin Gall Stone Forceps, Fig. 2, 9"
  
- 601-054 Lovelace Gall Bladder Traction Forceps, 7 1/4"
  
- 601-252 Randall Kidney Stone Forceps, 1/4 Curved, 9-1/4"
- 601-260 Randall Kidney Stone Forceps, 1/2 Curved, 9"
- 601-278 Randall Kidney Stone Forceps, 3/4 Curved, 8"
- 601-286 Randall Kidney Stone Forceps, Fully Curved, 7-3/4"



620-054



620-104



620-138

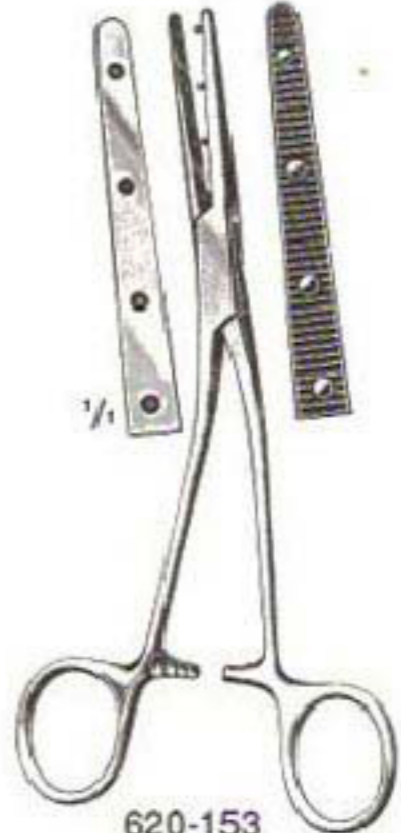

620-153

### THYROID INSTRUMENTS

- 620-054 Lovelace Thyroid Forceps, 6 1/4"m 2x2 Teeth
- 620-104 Lahey Thyroid Traction Forceps, 6 1/4", 3x3 Teeth
- 620-138 Kocher Bronchocele Sound, with Eye 6"
- 620-153 Mastin Muscle Clamp, 7"

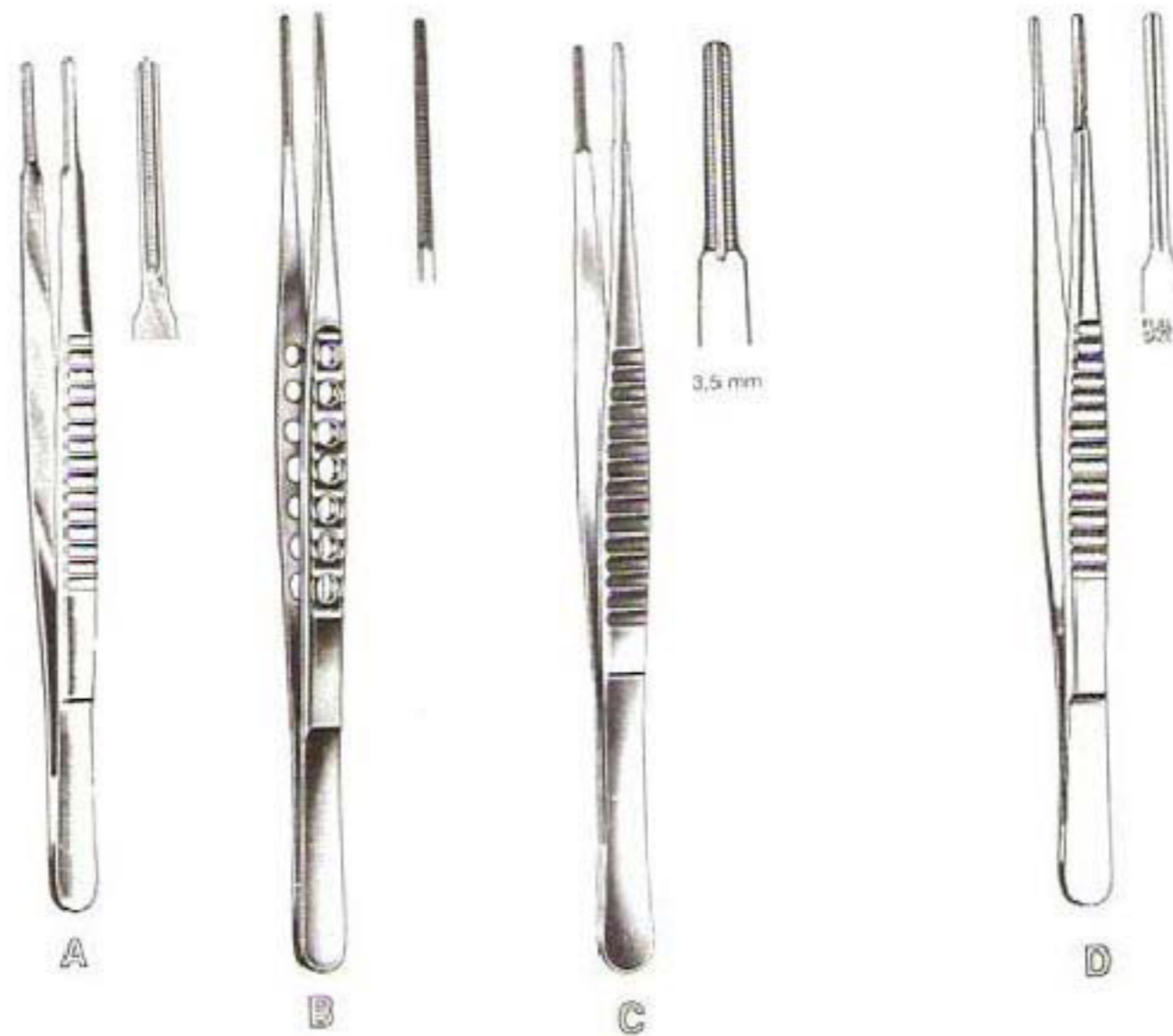

## ATRAUMATIC FORCEPS

- |          |         |   |
|----------|---------|---|
| <b>A</b> | 640-040 | DEBAKEY Thoracic Tissue Forceps, 6" (15.2 cm), 2.5 mm wide jaws                                   |
|          | 640-044 | DEBAKEY Thoracic Tissue Forceps, 7-3/4" (19.7 cm), 2.5 mm wide jaws                               |
|          | 640-048 | DEBAKEY Thoracic Tissue Forceps, 9-1/2" (24.1 cm), 2.5 mm wide jaws                               |
|          | 640-050 | DEBAKEY Thoracic Tissue Forceps, 12" (30.5 cm), 2.5 mm wide jaws                                  |
| <b>B</b> | 640-052 | DEBAKEY Vascular Tissue Forceps, 6" (15.2 cm), fenestrated handles, light weight, 1.5mm wide Jaws |
| <b>C</b> | 640-054 | DEBAKEY Thoracic Tissue Forceps, 6" (15.2 cm), 3.5 mm wide jaws                                   |
|          | 640-056 | DEBAKEY Thoracic Tissue Forceps, 7-3/4" (19.7 cm), 3.5 mm wide jaws                               |
|          | 640-058 | DEBAKEY Thoracic Tissue Forceps, 9-1/2" (24.1 cm), 3.5 mm wide jaws                               |
|          | 640-060 | DEBAKEY Thoracic Tissue Forceps, 12" (30.5 cm), 3.5 mm wide jaws                                  |
| <b>D</b> | 640-062 | COOLEY Vascular Tissue Forceps, 6" (15.2 cm), 2 mm jaws   |
|          | 640-064 | COOLEY Vascular Tissue Forceps, 8" (20.3 cm), 2 mm jaws   |

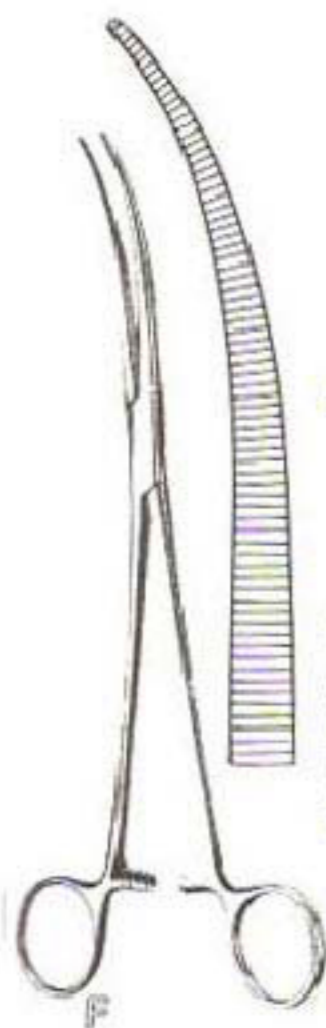

## CARDIOVASCULAR INSTRUMENTS

- |   |         |   |
|---|---------|---|
| A | 640-084 | DeBakey Type Vascular Tissue Forceps, Straight, 6-1/4", 1.5mm Wide Jaws |
|   | 640-086 | DeBakey Type Vascular Tissue Forceps, Straight, 8", 1.5mm Wide Jaws     |
|   | 640-094 | DeBakey Type Vascular Tissue Forceps, Straight, 9-3/4", 1.5mm Wide Jaws |
| B | 642-017 | Harken Clamps, Style #1, 9-1/2"   |
| C | 642-025 | Harken Clamps, Style #2, 9-1/2"   |
| D | 642-033 | Harken Clamps, Style #3, 9-1/2"   |
| E | 642-034 | Harken Clamps, Style #4, 9-1/2"   |
| F | 642-256 | Sarot (Crafoord) Thoracic Forceps, 9-1/2"                               |



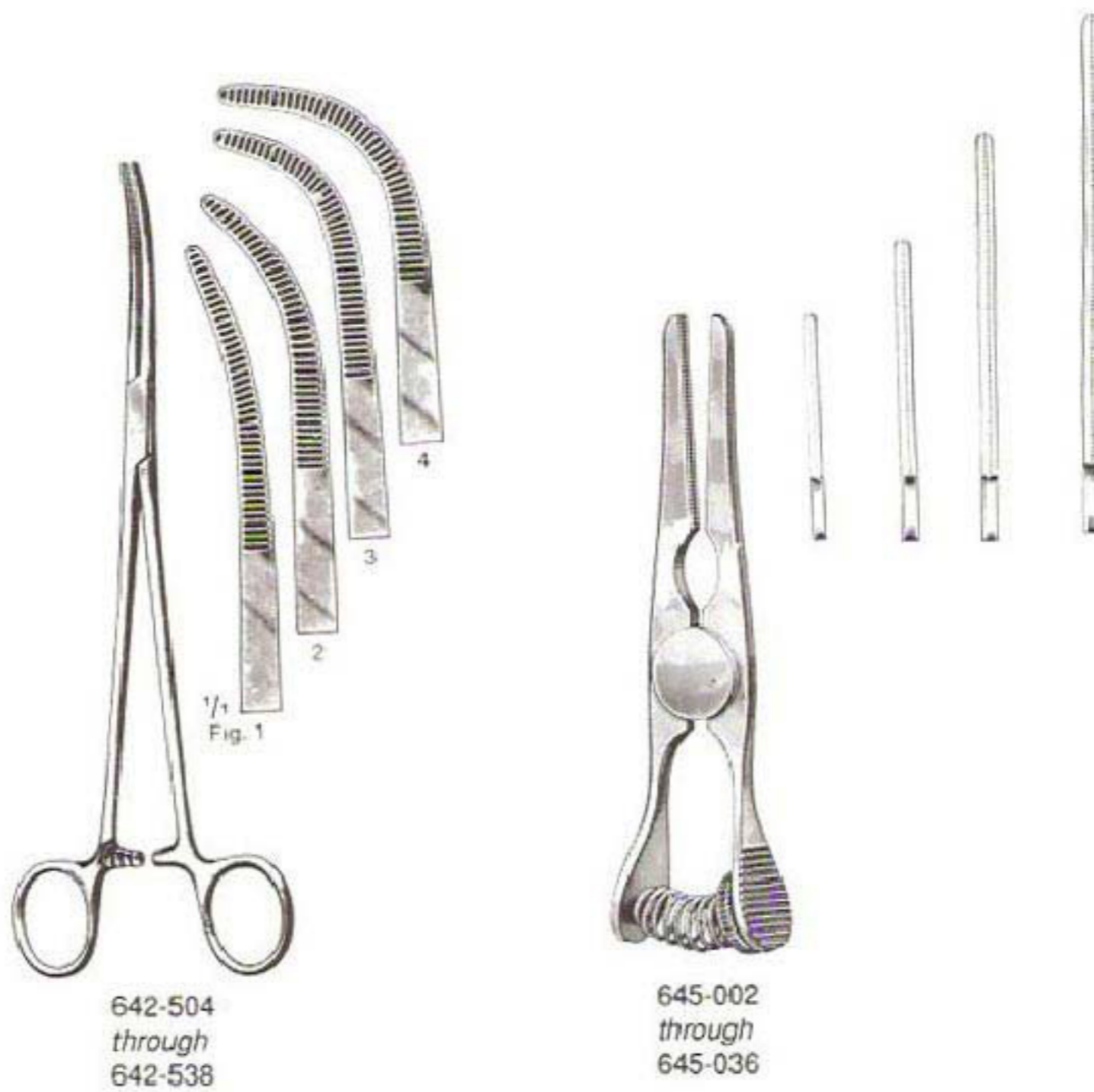

## ATRAUMATIC FORCEPS

### CARDIOVASCULAR INSTRUMENTS

642-504	RUMEL Thoracic Forceps, 9" (22.9 cm), slight curve, 2-3/8" (6.1 cm) long jaws
642-512	RUMEL Thoracic Forceps, 9" (22.9 cm), medium curve, 2-3/8" (6.1 cm) long jaws
642-520	RUMEL Thoracic Forceps, 9" (22.9 cm), full curve, 2-3/8" (6.1 cm) long jaws
642-538	RUMEL Thoracic Forceps, 9" (22.9 cm), angular, 2-3/8" (6.1 cm) long jaws
645-002	GLOVER Bulldog Clamp, straight, 2-1/2" ( 6.3 cm), 1.8cm Jaw
645-010	GLOVER Bulldog Clamp, straight, 2-3/4" ( 7.0 cm), 2cm Jaw
645-028	GLOVER Bulldog Clamp, straight, 3-1/2" ( 9.0 cm), 2.5cm Jaw
645-036	GLOVER Bulldog Clamp, straight, 4-1/2" ( 11.4 cm), 6cm Jaw



645-101  
through  
645-135



645-358  
645-366  
645-374  
645-376

### ATRAUMATIC FORCEPS CARDIOVASCULAR INSTRUMENTS



645-457  
through  
645-474

- |         |   |
|---------|---|
| 645-101 | GLOVER Bulldog Clamp, Curved,<br>2-1/2" ( 6.3 cm), 1.8cm Jaw  |
| 645-119 | GLOVER Bulldog Clamp, Curved,<br>2-3/4" ( 7.0 cm), 2cm Jaw    |
| 645-127 | GLOVER Bulldog Clamp, Curved,<br>3-1/2" ( 9.0 cm), 2.5cm Jaw  |
| 645-135 | GLOVER Bulldog Clamp, Curved,<br>4-1/2" ( 11.4 cm), 6cm Jaw   |
| 645-358 | DEBAKEY Bulldog Clamp, Straight,<br>3" (7.5cm), 2cm Jaw       |
| 645-366 | DEBAKEY Bulldog Clamp, Straight,<br>3-1/2" (8.5cm), 3cm Jaw   |
| 645-374 | DEBAKEY Bulldog Clamp, Straight,<br>4-1/4"(10.5cm), 4.5cm Jaw |
| 645-376 | DEBAKEY Bulldog Clamp, Straight,<br>4-3/4"(12cm), 6cm Jaw     |
| 645-457 | DEBAKEY Bulldog Clamp, curved,<br>3"(7.5cm), 2cm Jaw          |
| 645-465 | DEBAKEY Bulldog Clamp, curved,<br>3-1/2"(8.5cm), 3cm Jaw      |
| 645-473 | DEBAKEY Bulldog Clamp, curved,<br>4-1/4"(10.5cm), 4.5cm Jaw   |
| 645-474 | DEBAKEY Bulldog Clamp, curved,<br>4-3/4"(12cm), 6cm Jaw       |



## CARDIOVASCULAR INSTRUMENTS

- |          |         |   |
|----------|---------|---|
| <b>A</b> | 645-507 | Johns Hopkins Bulldog Clamp, Curved, 1-1/2", 10mm Jaw |
|          | 645-515 | Johns Hopkins Bulldog Clamp, Curved, 2", 15mm Jaw     |
|          | 645-523 | Johns Hopkins Bulldog Clamp, Curved, 2-1/4", 20mm Jaw |
|          | 645-531 | Johns Hopkins Bulldog Clamp, Curved, 2-1/2", 30mm Jaw |
|          | 645-549 | Johns Hopkins Bulldog Clamp, Curved, 2-3/4", 40mm Jaw |
|          | 645-556 | Johns Hopkins Bulldog Clamp, Curved, 3", 50mm Jaw     |
|          | 645-564 | Johns Hopkins Bulldog Clamp, Curved, 3-1/2", 55mm Jaw |
| <b>B</b> | 645-804 | DeBakey Tangential Occlusion Clamp, 8"                |
|          | 645-812 | DeBakey Tangential Occlusion Clamp, 10"               |
|          | 645-820 | DeBakey Tangential Occlusion Clamp, 10-1/4"           |
|          | 645-838 | DeBakey Tangential Occlusion Clamp, 10-1/2"           |
|          | 645-846 | DeBakey Tangential Occlusion Clamp, 11"               |

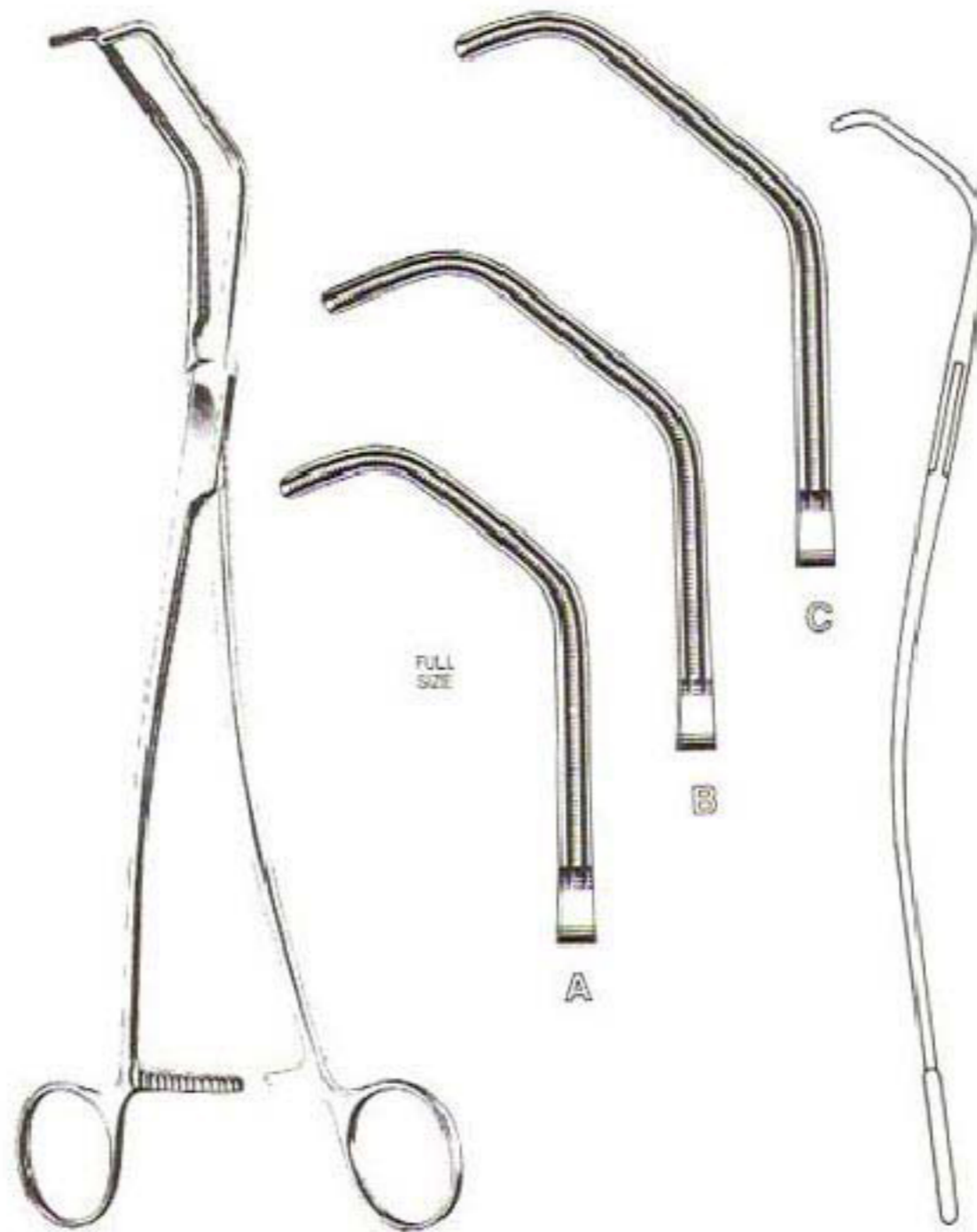

## ATRAUMATIC FORCEPS

- |          |         |   |
|----------|---------|---|
| <b>A</b> | 640-096 | Satinsky-DeBakey Vascular Clamp for Vena Cava 9-3/4" (24.8cm), small  |
| <b>B</b> | 640-098 | Satinsky-DeBakey Vascular Clamp for Vena Cava 9-3/4" (24.8cm), medium |
| <b>C</b> | 640-100 | Satinsky-DeBakey Vascular Clamp for Vena Cava 9-3/4" (24.8cm), large  |

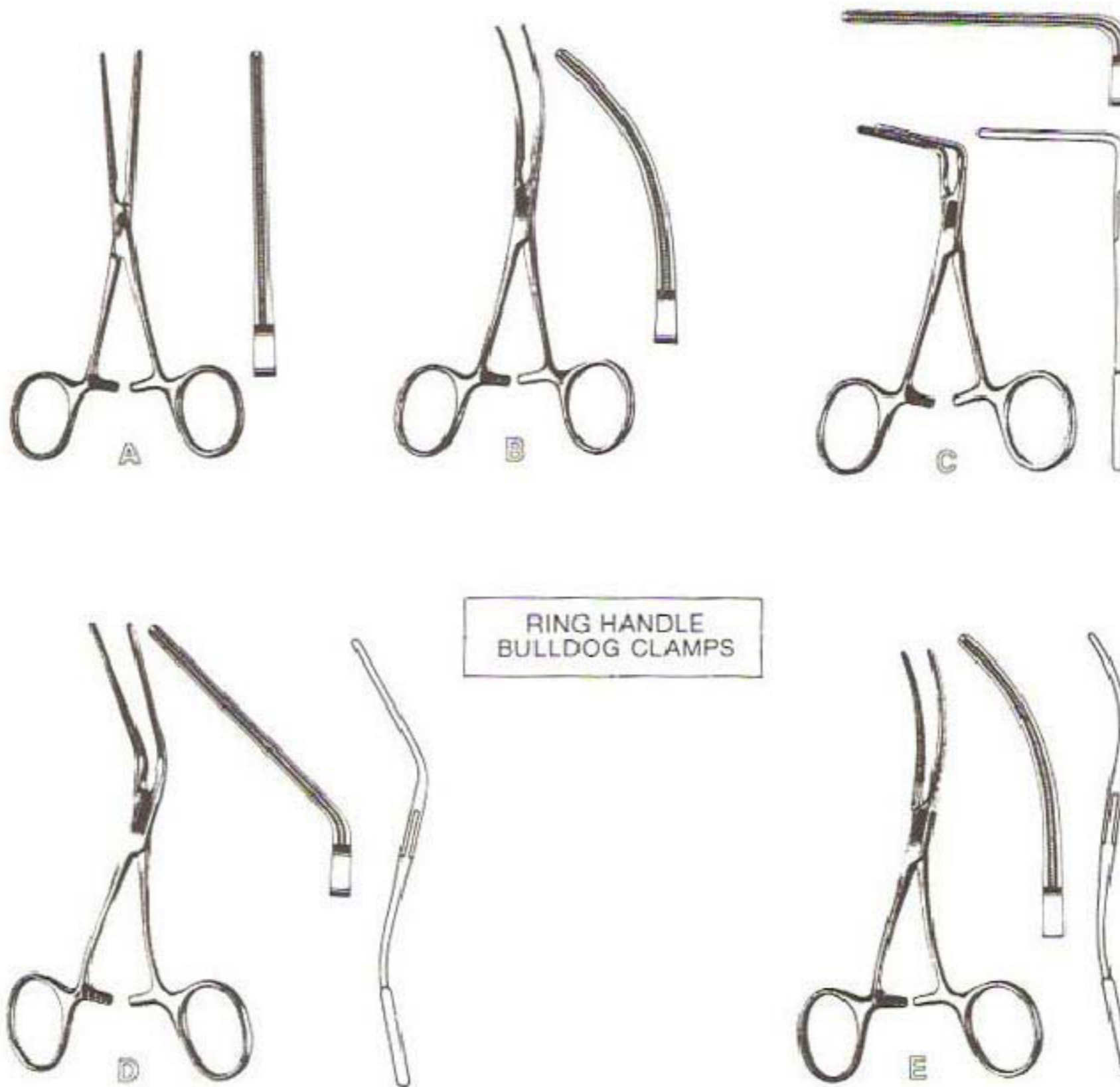

### ATRAUMATIC FORCEPS

- |         |   |   |
|---------|---|---|
| 640-110 | A | DeBakey Ring Handled Bulldog Clamps, 5-1/8", Straight |
| 640-115 | B | DeBakey Ring Handled Bulldog Clamps, 5", Curved       |
| 640-120 | C | DeBakey Ring Handled Bulldog Clamps, 4-3/4", 90°      |
| 640-125 | D | DeBakey Ring Handled Bulldog Clamps, 4-3/4", 45°      |
| 640-130 | E | DeBakey Ring Handled Bulldog Clamps, 5", S-Curved     |

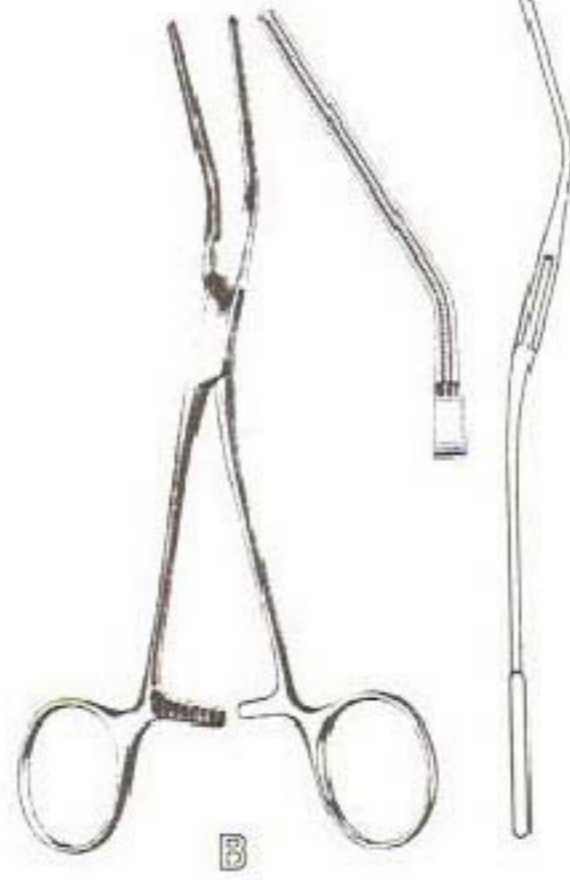

### ATRAUMATIC FORCEPS

- A 640-135 DeBakey Pediatric Multi-Purpose Clamp, 6-1/4", Straight
- B 640-140 DeBakey Pediatric Multi-Purpose Clamp, 6", 30° Angled
- C 640-145 DeBakey Pediatric Multi-Purpose Clamp, 6", 60° Angled
- D 640-150 DeBakey Pediatric Multi-Purpose Clamp, 5-1/2", 90° Angled

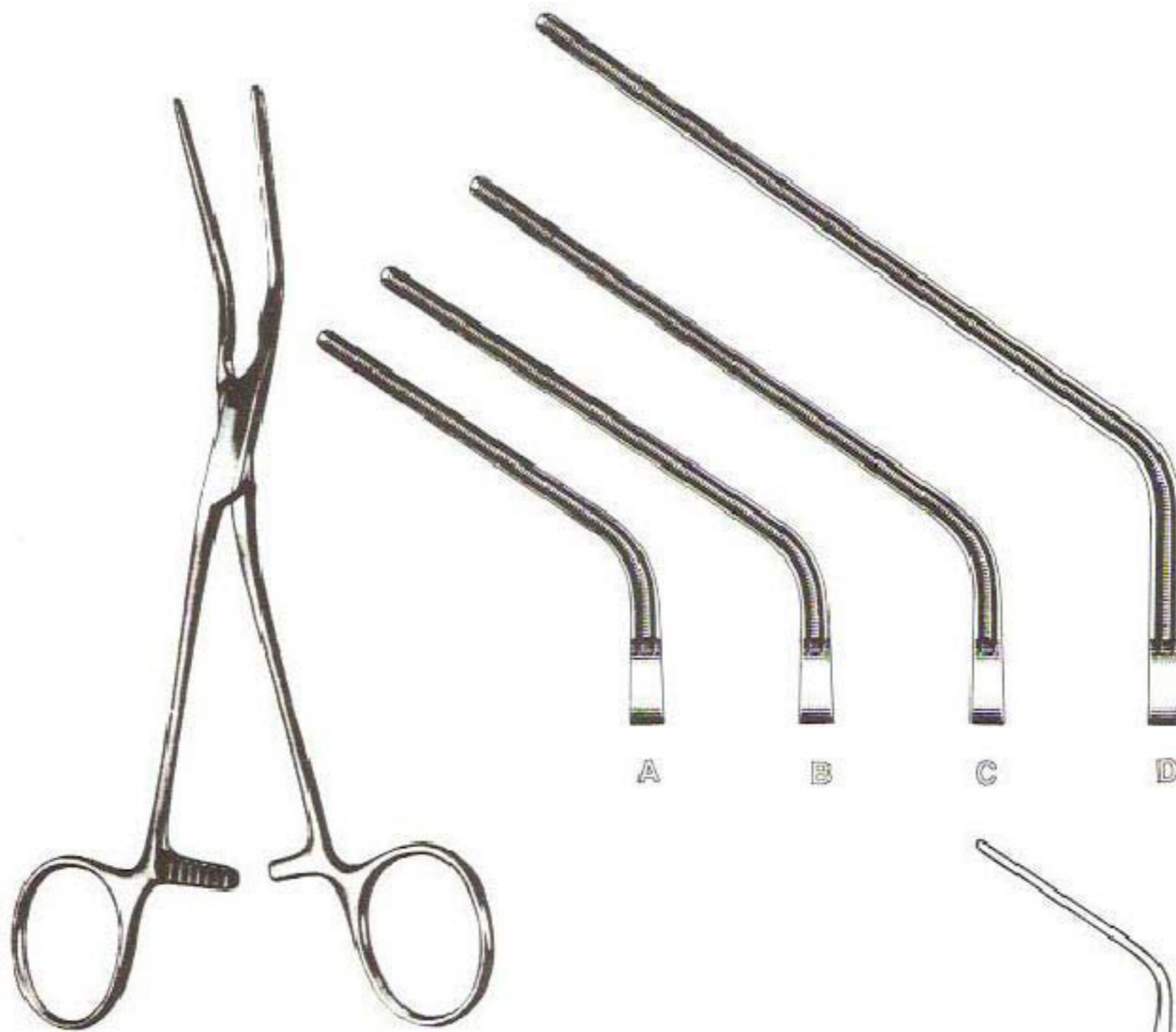

### ATRAUMATIC FORCEPS

- 640-155 **A** DeBakey Multi-Purpose Clamps, Obtuse Angle, 60°, 9-1/2" Long, 4cm Jaws
- 640-160 **B** DeBakey Multi-Purpose Clamps, Obtuse Angle, 60°, 8-1/4" Long, 5cm Jaws
- 640-165 **C** DeBakey Multi-Purpose Clamps, Obtuse Angle, 60°, 9-1/2" Long, 6cm Jaws
- 640-170 **D** DeBakey Multi-Purpose Clamps, Obtuse Angle, 60°, 12" Long, 10cm Jaws



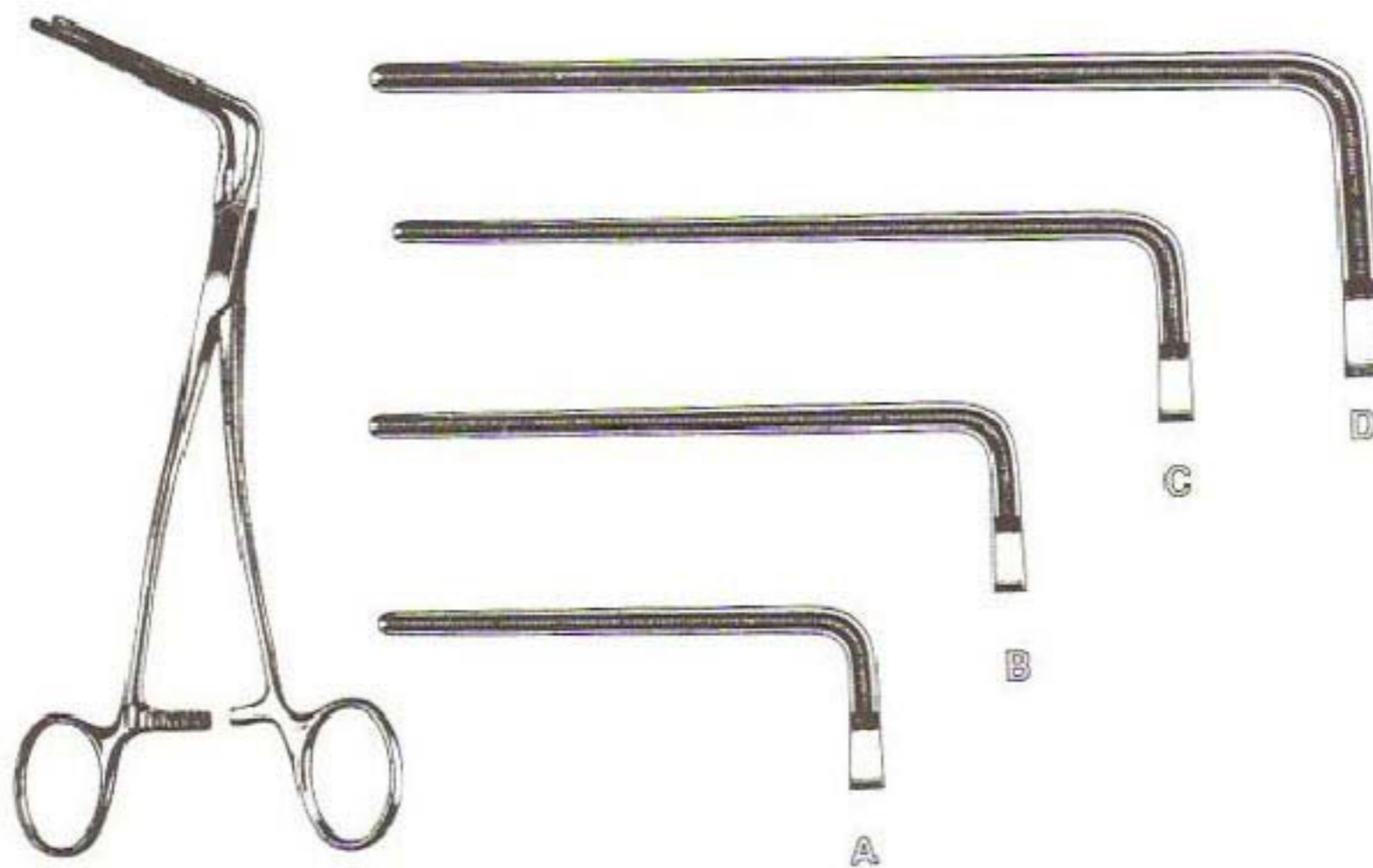

## ATRAUMATIC FORCEPS

- 640-175 **A** DeBakey Multi-Purpose Clamps, Right Angle, 90°, 9" Long, 4cm Jaws
- 640-180 **B** DeBakey Multi-Purpose Clamps, Right Angle, 90°, 8" Long, 5cm Jaws
- 640-185 **C** DeBakey Multi-Purpose Clamps, Right Angle, 90°, 8" Long, 6.5cm Jaws
- 640-190 **D** DeBakey Multi-Purpose Clamps, Right Angle, 90°, 10-1/2" Long, 10cm Jaws



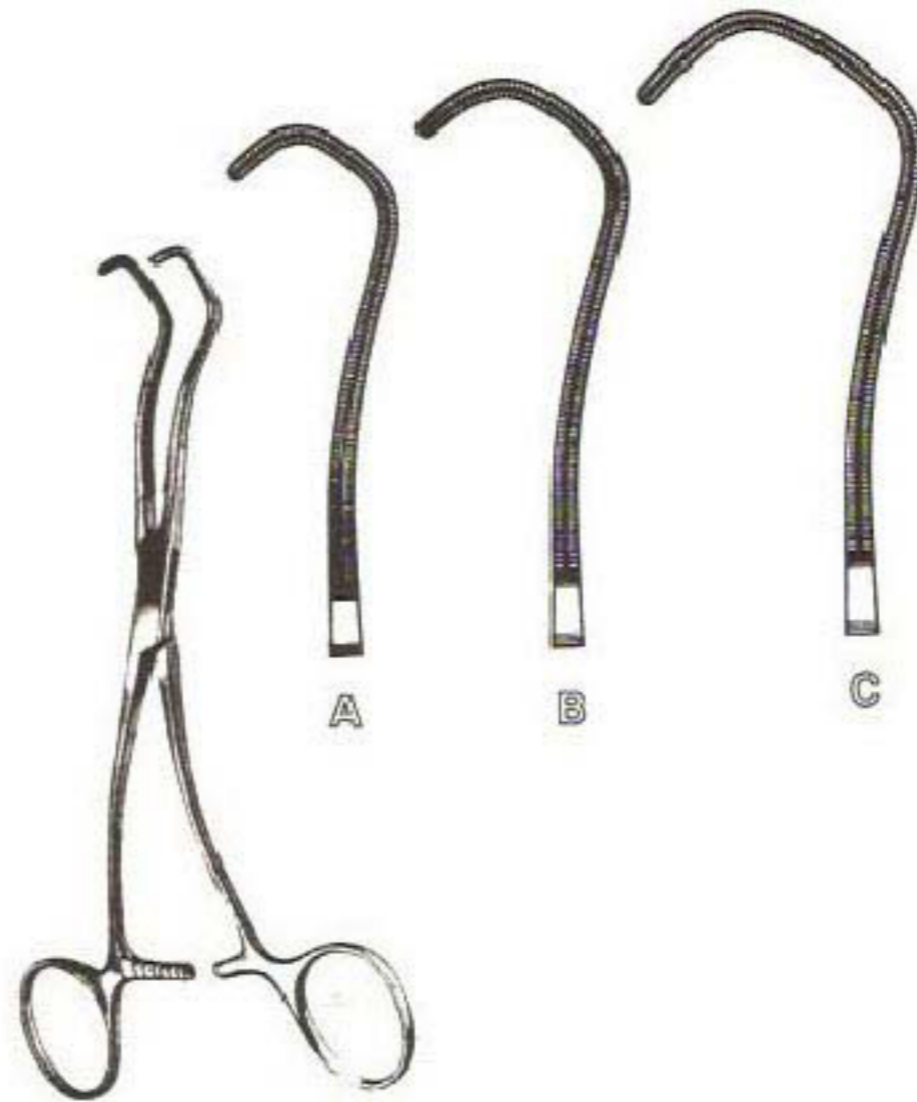

### ATRAUMATIC FORCEPS

- 640-195    **A** Cooley-Derra Pediatric Anastomosis Clamp, Small, 6-1/2"
- 640-200    **B** Cooley-Derra Pediatric Anastomosis Clamp, Medium, 6-1/2"
- 640-205    **C** Cooley-Derra Pediatric Anastomosis Clamp, Large, 6-1/2"



FISTULA  
1/2 Circle  
Cutting Edge

- 650-100 Fistula Needle, 1/2 Circle, Cutting Edge, #00
- 650-110 Fistula Needle, 1/2 Circle, Cutting Edge, #0
- 650-111 Fistula Needle, 1/2 Circle, Cutting Edge, #1
- 650-112 Fistula Needle, 1/2 Circle, Cutting Edge, #2
- 650-113 Fistula Needle, 1/2 Circle, Cutting Edge, #3
- 650-114 Fistula Needle, 1/2 Circle, Cutting Edge, #4
- 650-115 Fistula Needle, 1/2 Circle, Cutting Edge, #5
- 650-116 Fistula Needle, 1/2 Circle, Cutting Edge, #6
- 650-117 Fistula Needle, 1/2 Circle, Cutting Edge, #7
- 650-118 Fistula Needle, 1/2 Circle, Cutting Edge, #8
- 650-119 Fistula Needle, 1/2 Circle, Cutting Edge, #9

### SURGEONS NEEDLES

- 650-125 Regular Surgeons Needle, 1/2 Circle, Cutting Edge, #0
- 650-127 Regular Surgeons Needle, 1/2 Circle, Cutting Edge, #1
- 650-129 Regular Surgeons Needle, 1/2 Circle, Cutting Edge, #2
- 650-131 Regular Surgeons Needle, 1/2 Circle, Cutting Edge, #3
- 650-133 Regular Surgeons Needle, 1/2 Circle, Cutting Edge, #4
- 650-135 Regular Surgeons Needle, 1/2 Circle, Cutting Edge, #5
- 650-137 Regular Surgeons Needle, 1/2 Circle, Cutting Edge, #6
- 650-139 Regular Surgeons Needle, 1/2 Circle, Cutting Edge, #7
- 650-141 Regular Surgeons Needle, 1/2 Circle, Cutting Edge, #8
- 650-143 Regular Surgeons Needle, 1/2 Circle, Cutting Edge, #9
- 650-145 Regular Surgeons Needle, 1/2 Circle, Cutting Edge, #10
- 650-147 Regular Surgeons Needle, 1/2 Circle, Cutting Edge, #11
- 650-149 Regular Surgeons Needle, 1/2 Circle, Cutting Edge, #12
- 650-151 Regular Surgeons Needle, 1/2 Circle, Cutting Edge, #13
- 650-153 Regular Surgeons Needle, 1/2 Circle, Cutting Edge, #14
- 650-155 Regular Surgeons Needle, 1/2 Circle, Cutting Edge, #15
- 650-157 Regular Surgeons Needle, 1/2 Circle, Cutting Edge, #16
- 650-159 Regular Surgeons Needle, 1/2 Circle, Cutting Edge, #17
- 650-161 Regular Surgeons Needle, 1/2 Circle, Cutting Edge, #18
- 650-163 Regular Surgeons Needle, 1/2 Circle, Cutting Edge, #19
- 650-165 Regular Surgeons Needle, 1/2 Circle, Cutting Edge, #20



REGULAR SURGEON'S  
1/2 Circle  
Cutting Edge

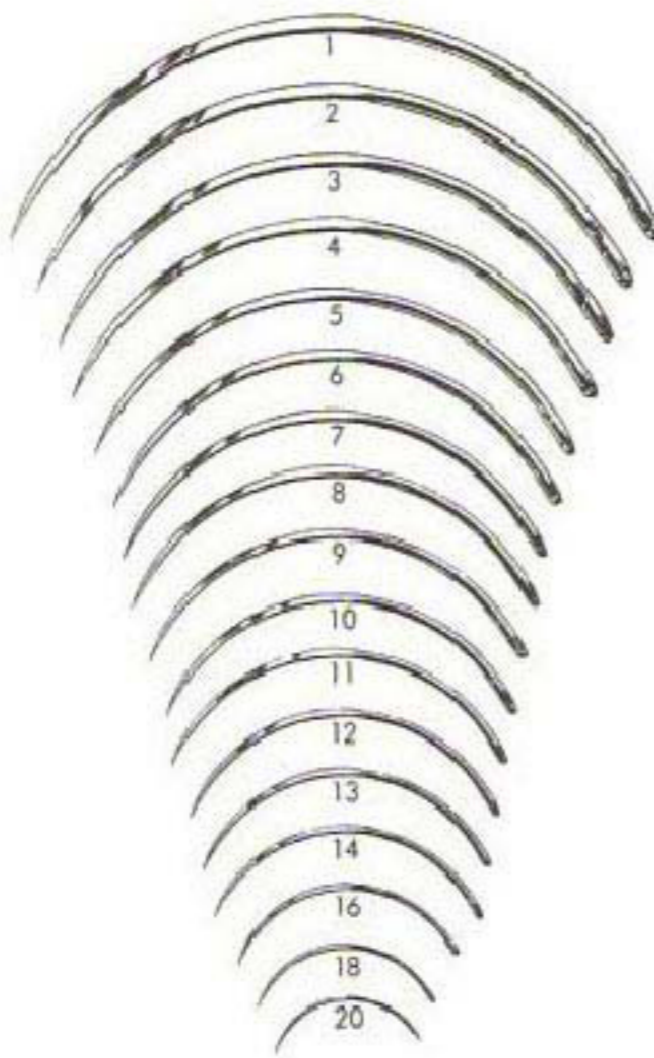

3/8 circle - cutting edge

## SURGEONS NEEDLES

650-201	Regular Surgeons Needles, 3/8 Circle, Cutting Edge, #1
650-202	Regular Surgeons Needles, 3/8 Circle, Cutting Edge, #2
650-203	Regular Surgeons Needles, 3/8 Circle, Cutting Edge, #3
650-204	Regular Surgeons Needles, 3/8 Circle, Cutting Edge, #4
650-205	Regular Surgeons Needles, 3/8 Circle, Cutting Edge, #5
650-206	Regular Surgeons Needles, 3/8 Circle, Cutting Edge, #6
650-207	Regular Surgeons Needles, 3/8 Circle, Cutting Edge, #7
650-208	Regular Surgeons Needles, 3/8 Circle, Cutting Edge, #8
650-209	Regular Surgeons Needles, 3/8 Circle, Cutting Edge, #9
650-210	Regular Surgeons Needles, 3/8 Circle, Cutting Edge, #10
650-211	Regular Surgeons Needles, 3/8 Circle, Cutting Edge, #11
650-212	Regular Surgeons Needles, 3/8 Circle, Cutting Edge, #12
650-213	Regular Surgeons Needles, 3/8 Circle, Cutting Edge, #13
650-214	Regular Surgeons Needles, 3/8 Circle, Cutting Edge, #14
650-215	Regular Surgeons Needles, 3/8 Circle, Cutting Edge, #16
650-216	Regular Surgeons Needles, 3/8 Circle, Cutting Edge, #18
650-218	Regular Surgeons Needles, 3/8 Circle, Cutting Edge, #20
650-220	Regular Surgeons Needles, 3/8 Circle, Cutting Edge, #21



### KEITH ABDOMINAL Straight Traingular Point

650-224	Keith Abdominal Needles, Straight, Triangular Point, 4"
650-226	Keith Abdominal Needles, Straight, Triangular Point, 3-1/2"
650-228	Keith Abdominal Needles, Straight, Triangular Point, 3"
650-230	Keith Abdominal Needles, Straight, Triangular Point, 2-7/8"
650-232	Keith Abdominal Needles, Straight, Triangular Point, 2-1/8"
650-234	Keith Abdominal Needles, Straight, Triangular Point, 2"
650-236	Keith Abdominal Needles, Straight, Triangular Point, 1-3/4"
650-238	Keith Abdominal Needles, Straight, Triangular Point, 1-1/2"

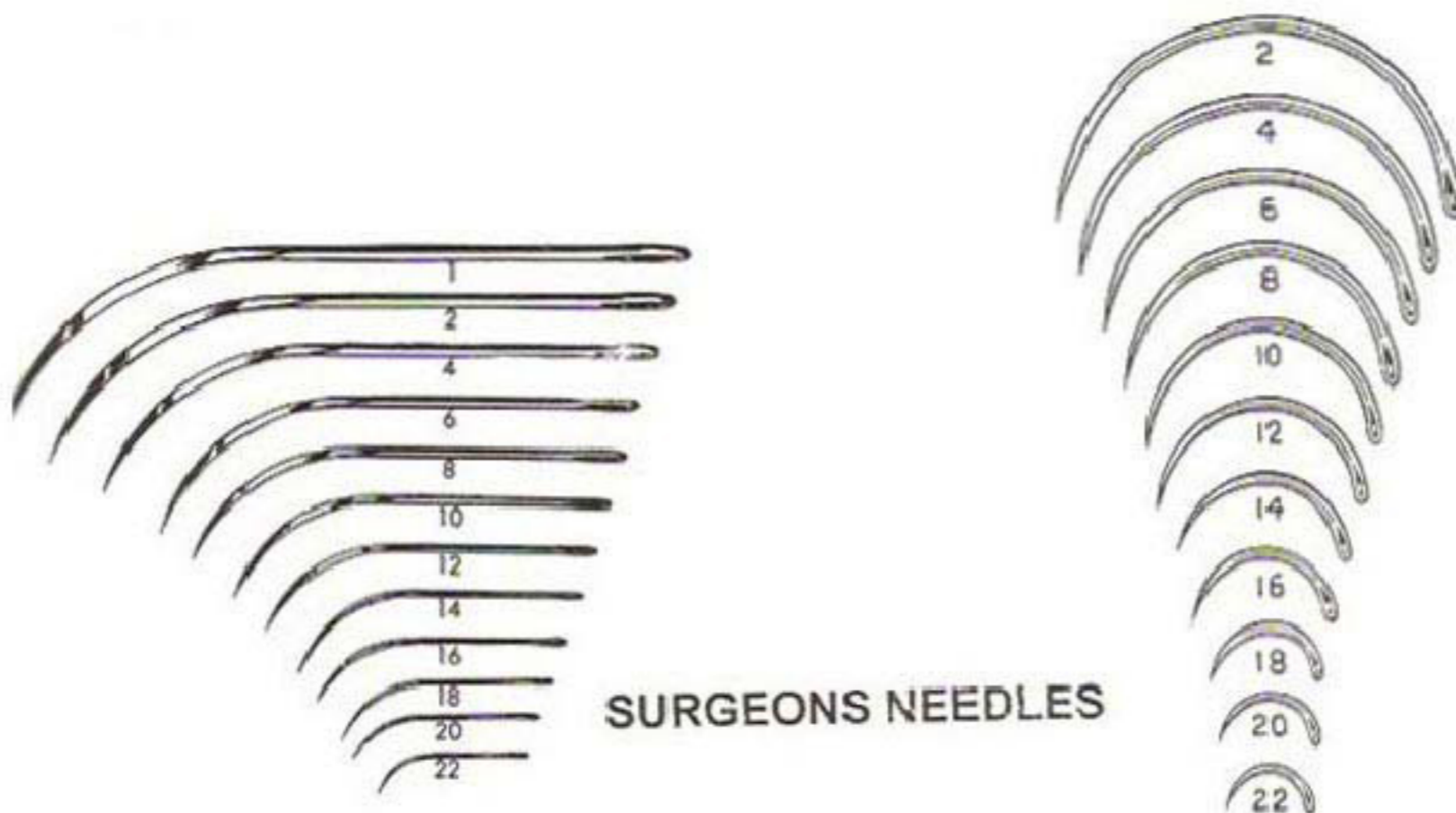

half curved - cutting edge

1/2 circle - taper point

650-299	Regular Surgeons Needles, 1/2 Curved, Cutting Edge, #0
650-301	Regular Surgeons Needles, 1/2 Curved, Cutting Edge, #1
650-302	Regular Surgeons Needles, 1/2 Curved, Cutting Edge, #2
650-304	Regular Surgeons Needles, 1/2 Curved, Cutting Edge, #4
650-306	Regular Surgeons Needles, 1/2 Curved, Cutting Edge, #6
650-308	Regular Surgeons Needles, 1/2 Curved, Cutting Edge, #8
650-310	Regular Surgeons Needles, 1/2 Curved, Cutting Edge, #10
650-312	Regular Surgeons Needles, 1/2 Curved, Cutting Edge, #12
650-314	Regular Surgeons Needles, 1/2 Curved, Cutting Edge, #14
650-316	Regular Surgeons Needles, 1/2 Curved, Cutting Edge, #16
650-320	Regular Surgeons Needles, 1/2 Curved, Cutting Edge, #20
650-322	Regular Surgeons Needles, 1/2 Curved, Cutting Edge, #22
650-402	Regular Surgeons Needles, 1/2 Curved, Tapered Point, #2
650-404	Regular Surgeons Needles, 1/2 Curved, Tapered Point, #4
650-406	Regular Surgeons Needles, 1/2 Curved, Tapered Point, #6
650-408	Regular Surgeons Needles, 1/2 Curved, Tapered Point, #8
650-410	Regular Surgeons Needles, 1/2 Curved, Tapered Point, #10
650-412	Regular Surgeons Needles, 1/2 Curved, Tapered Point, #12
650-414	Regular Surgeons Needles, 1/2 Curved, Tapered Point, #14
650-416	Regular Surgeons Needles, 1/2 Curved, Tapered Point, #16
650-418	Regular Surgeons Needles, 1/2 Curved, Tapered Point, #18
650-420	Regular Surgeons Needles, 1/2 Curved, Tapered Point, #20
650-422	Regular Surgeons Needles, 1/2 Curved, Tapered Point, #22



## SURGEONS NEEDLES

All needles shown  
actual size.



3/8 circle - cutting edge

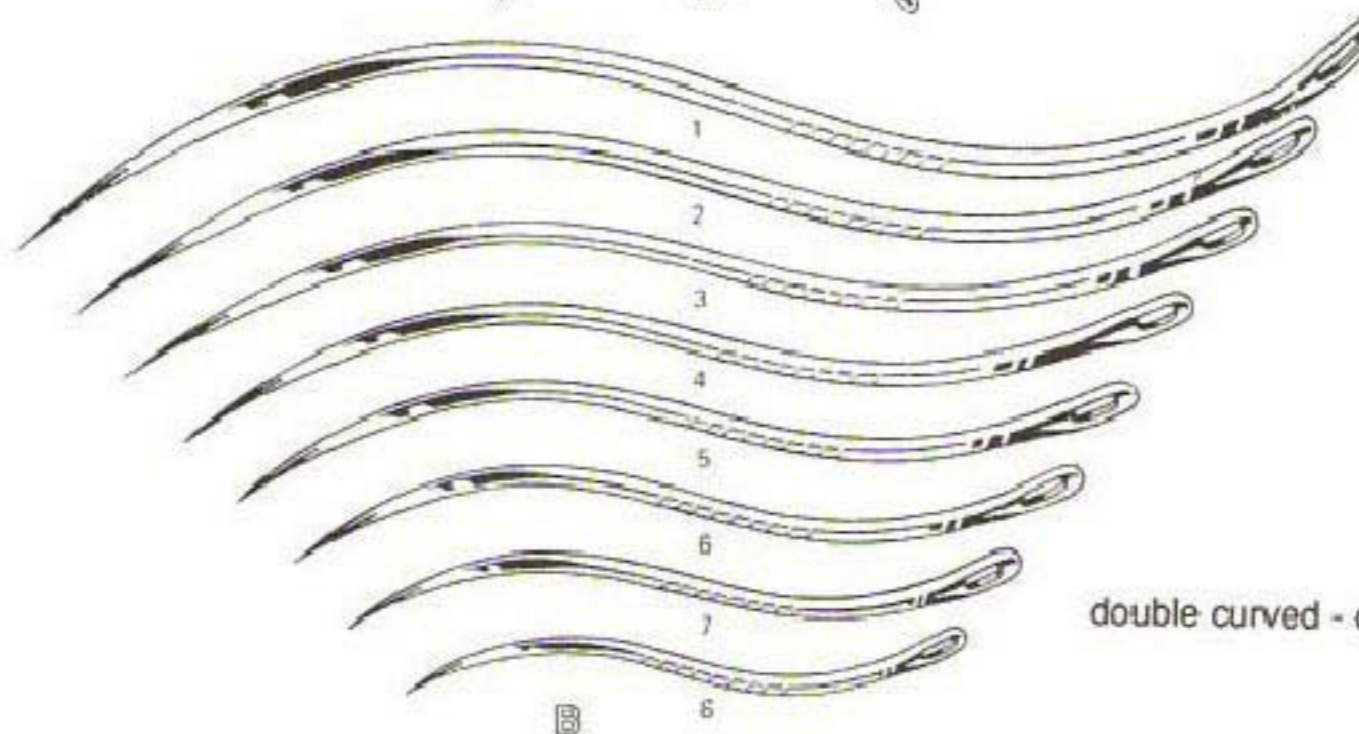

double curved - cutting edge

- |   |         |  |
|---|---------|--|
| A | 650-501 | Veterinary Needles, 3/8 Circle, Cutting Edge, #1       |
|   | 650-502 | Veterinary Needles, 3/8 Circle, Cutting Edge, #2       |
|   | 650-503 | Veterinary Needles, 3/8 Circle, Cutting Edge, #3       |
|   | 650-504 | Veterinary Needles, 3/8 Circle, Cutting Edge, #4       |
|   | 650-505 | Veterinary Needles, 3/8 Circle, Cutting Edge, #5       |
|   | 650-506 | Veterinary Needles, 3/8 Circle, Cutting Edge, #6       |
|   | 650-507 | Veterinary Needles, 3/8 Circle, Cutting Edge, #7       |
|   | 650-508 | Veterinary Needles, 3/8 Circle, Cutting Edge, #8       |
| B | 650-601 | Post Mortem Needles, Double Curve Cutting Edge, Size 1 |
|   | 650-602 | Post Mortem Needles, Double Curve Cutting Edge, Size 2 |
|   | 650-603 | Post Mortem Needles, Double Curve Cutting Edge, Size 3 |
|   | 650-604 | Post Mortem Needles, Double Curve Cutting Edge, Size 4 |
|   | 650-605 | Post Mortem Needles, Double Curve Cutting Edge, Size 5 |
|   | 650-606 | Post Mortem Needles, Double Curve Cutting Edge, Size 6 |
|   | 650-607 | Post Mortem Needles, Double Curve Cutting Edge, Size 7 |
|   | 650-608 | Post Mortem Needles, Double Curve Cutting Edge, Size 8 |

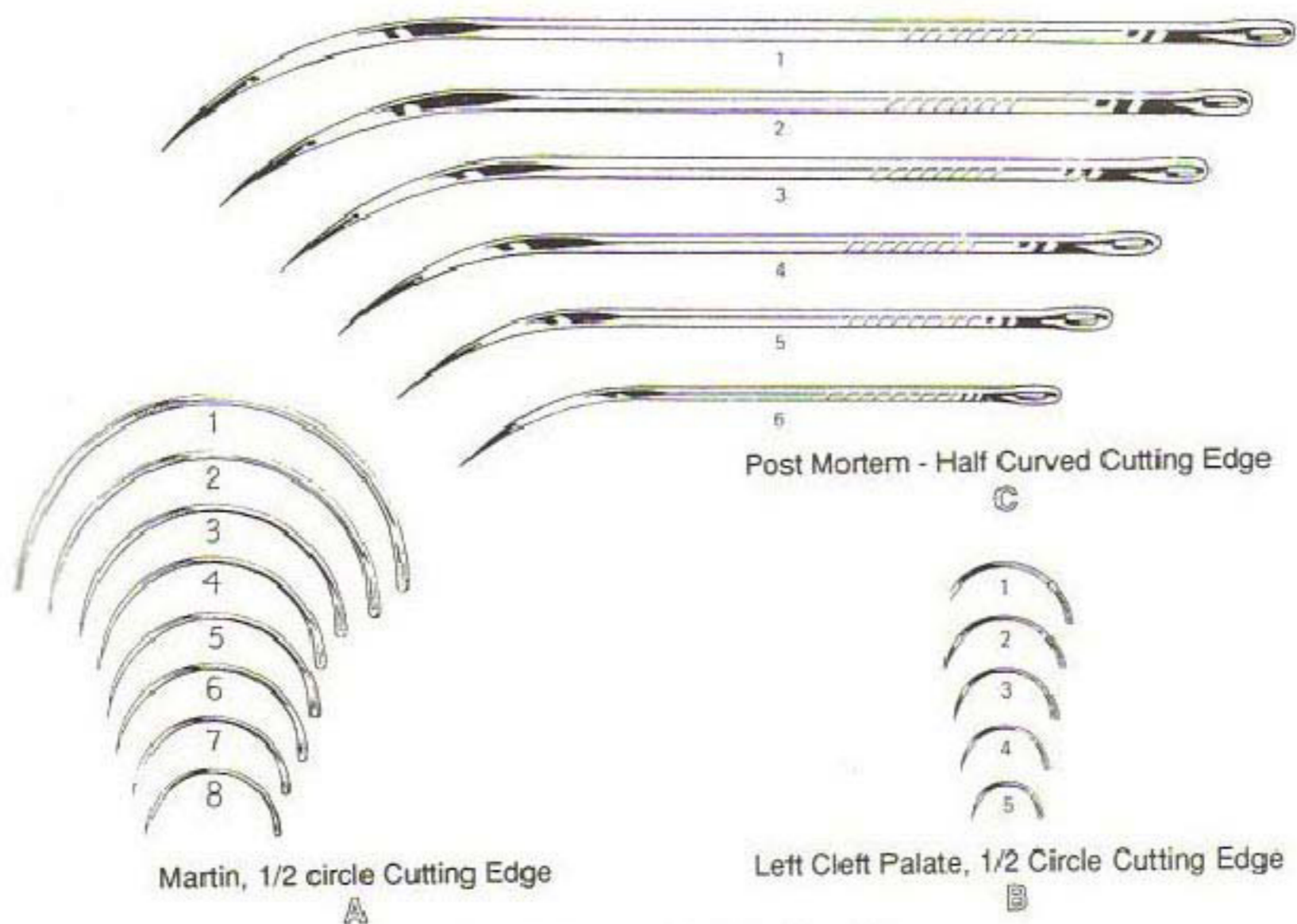

## SURGEONS NEEDLES

- |   |         |   |
|---|---------|---|
| A | 650-701 | Martin Uterine Needles, 1/2 Curved Cutting Edge, #1 |
|   | 650-702 | Martin Uterine Needles, 1/2 Curved Cutting Edge, #2 |
|   | 650-703 | Martin Uterine Needles, 1/2 Curved Cutting Edge, #3 |
|   | 650-704 | Martin Uterine Needles, 1/2 Curved Cutting Edge, #4 |
|   | 650-705 | Martin Uterine Needles, 1/2 Curved Cutting Edge, #5 |
|   | 650-706 | Martin Uterine Needles, 1/2 Curved Cutting Edge, #6 |
|   | 650-707 | Martin Uterine Needles, 1/2 Curved Cutting Edge, #7 |
|   | 650-708 | Martin Uterine Needles, 1/2 Curved Cutting Edge, #8 |
| B | 650-801 | Lane Cleft Palate, 1/2 Circle, Cutting Edge, #1     |
|   | 650-802 | Lane Cleft Palate, 1/2 Circle, Cutting Edge, #2     |
|   | 650-803 | Lane Cleft Palate, 1/2 Circle, Cutting Edge, #3     |
|   | 650-804 | Lane Cleft Palate, 1/2 Circle, Cutting Edge, #4     |
|   | 650-805 | Lane Cleft Palate, 1/2 Circle, Cutting Edge, #5     |
| C | 650-901 | Post Mortem Needles, Half Curved Cutting Edge, #1   |
|   | 650-902 | Post Mortem Needles, Half Curved Cutting Edge, #2   |
|   | 650-903 | Post Mortem Needles, Half Curved Cutting Edge, #3   |
|   | 650-904 | Post Mortem Needles, Half Curved Cutting Edge, #4   |
|   | 650-905 | Post Mortem Needles, Half Curved Cutting Edge, #5   |
|   | 650-906 | Post Mortem Needles, Half Curved Cutting Edge, #6   |



## THORACIC INSTRUMENTS

- |          |         |   |
|----------|---------|---|
| <b>A</b> | 661-002 | Collin-Duval Lung Grasping Forceps, with 1/2" wide jaws, 8"                   |
|          | 661-004 | Collin-Duval Lung Grasping Forceps, with 1" wide jaws, 8"                     |
| <b>B</b> | 661-006 | Lovelace Lung Grasping Forceps, angled shanks, serrated jaws, 1" wide, 7-1/2" |
| <b>C</b> | 661-007 | Lovelace Lung Grasping Forceps, straight, serrated jaws, 1" wide, 8"          |
| <b>D</b> | 661-008 | Mixer Thoracic Forceps, 9-1/4"  |
| <b>E</b> | 661-009 | Mixer Thoracic Forceps, 11-1/4"   |
| <b>F</b> | 661-010 | Satinsky Vena Cava Clamp, 10-1/2"   |



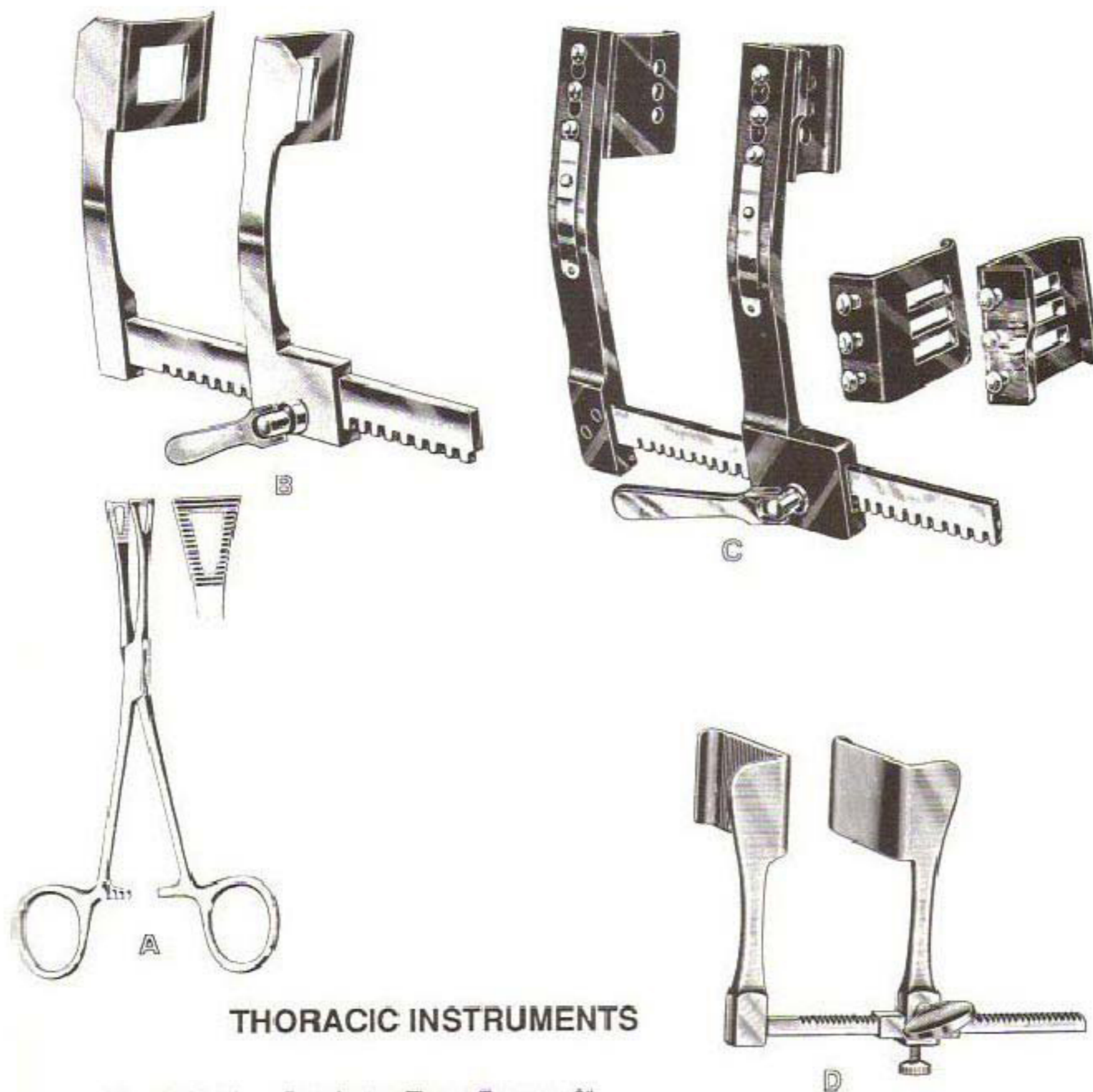

### THORACIC INSTRUMENTS

- A 661-011 Pennington Tissue Forceps, 8"
- B 662-056 Finochietto Rib Spreader, Small, 1 3/4" x 1 3/4" Blades, 6" Spread
- 662-056 Finochietto Rib Spreader, Medium, 1 3/4" x 2 1/4" Blades, 10" Spread
- 662-106 Finochietto Rib Spreader, Large, 2 3/4" x 2 1/2" Blades, 12" Spread
- BURFORD FINOCHIETTO, 2 Sets of interchangeable blades, light weight alloy
- C 662-155 Burford-Finochietto Retractor, Anodized Aluminium, 8" spread
- 662-156 Burford-Finochietto Retractor, Anodized Aluminium, 10" spread
- 662-158 Burford-Finochietto Retractor, Anodized Aluminium, 12" spread
- D 662-254 Tuffier Rib Spreader, 2" x 1 3/4" Blades with 6 1/2" Spread





662-304

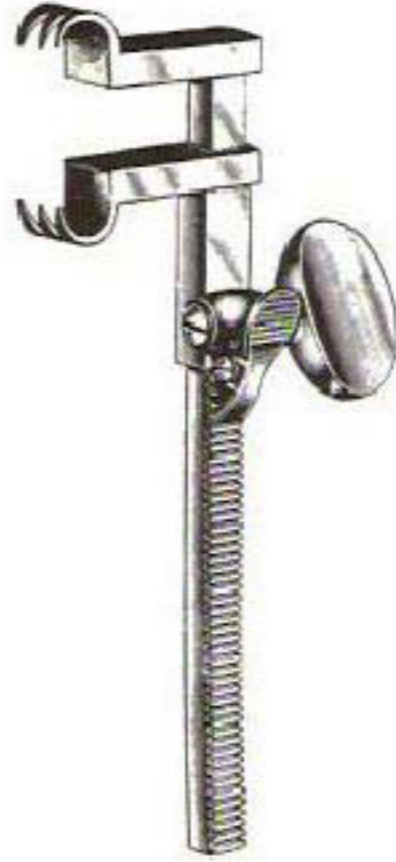

662-312



662-601



662-625

## THORACIC INSTRUMENTS

- |         |  |
|---------|--|
| 662-304 | Bailey Rib Contractor, 6 ½", Standard Model                                |
| 662-312 | Bailey-Gibbon Rib Contractor, 6 ½"   |
| 662-601 | Alexander-Farabeuf Periostome 8 ¼", Standard Size, 12mm and 24mm Wide Ends |
| 662-625 | Matson Rib Elevator and Stripper, 8 ¾"                                     |



### THORACIC INSTRUMENTS

- A** 662-650 Doyen Rib Elevator, Curved, Left, 7"
- B** 662-668 Doyen Rib Elevator, Curved, Right, 7"
- C** 663-252 Rib Shears, Plain, 9"
- D** 663-302 Gluck Rib Shear, 8 ½"
- E** 663-401 Lebsche Sternum Knife, 10"



**E**

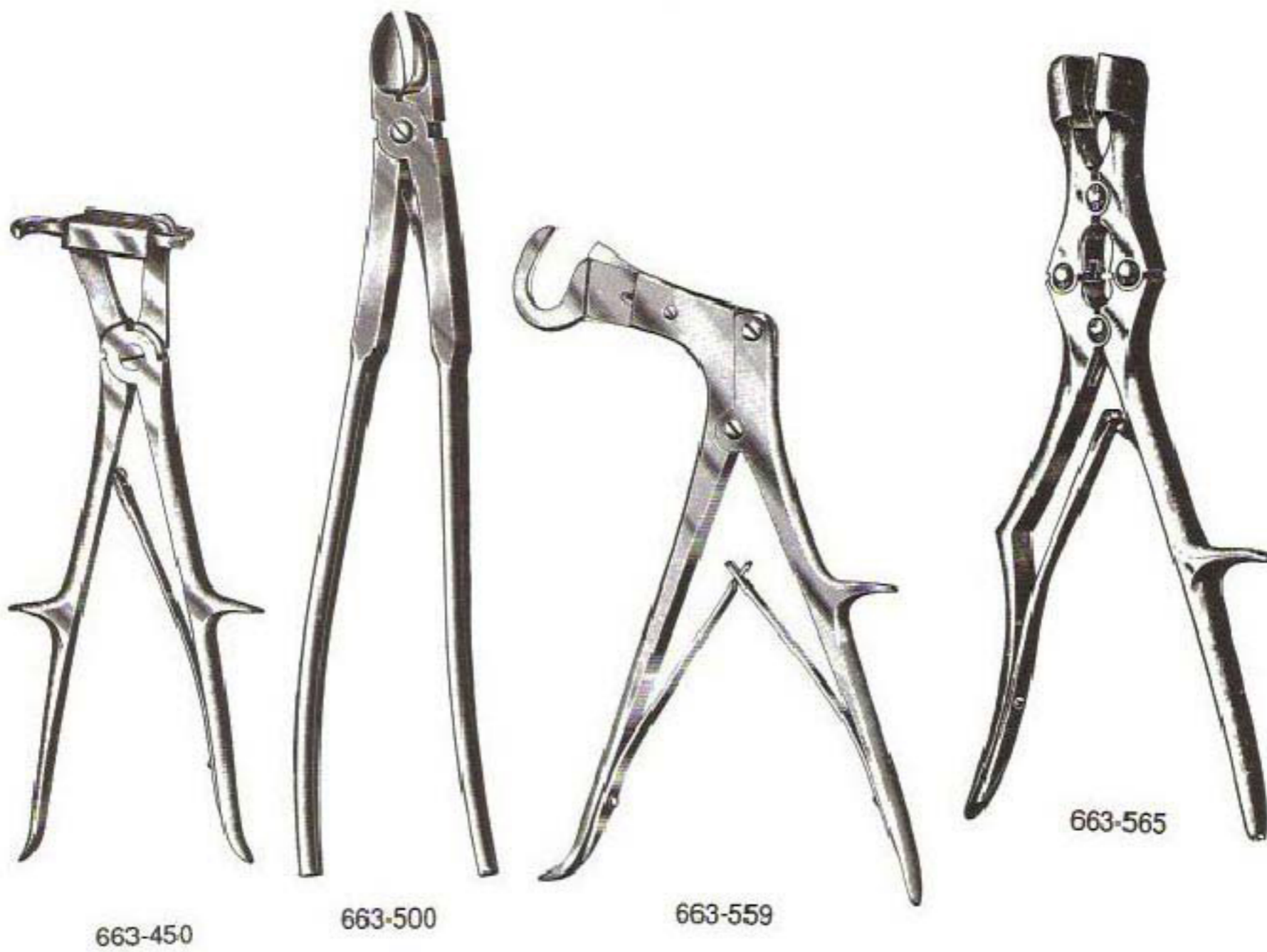

## THORACIC INSTRUMENTS

- |         |  |
|---------|--|
| 663-450 | Sauerbruch Rib Shears, 10"                               |
| 663-500 | Bethune Rib Shears, 13-1/2"                              |
| 663-559 | Giertz-Shoemaker Rib Shears, 10"                         |
| 663-565 | Sauerbruch Rongeur, 12" Straight, Square Jaws, 17mm Wide |

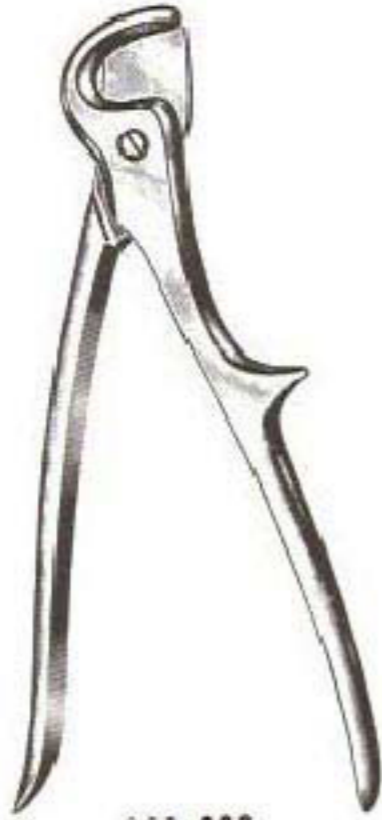

663-609



663-618



663-620



663-622

## THORACIC INSTRUMENTS

- 663-609 Stille Rib Shears, 8-1/2"
- 663-618 Bethune Rib Shears, 13 3/4", Left
- 663-620 Bethune Rib Shears, 13 3/4", Right
- 663-622 Davidson Scapula Retractor,  
Blade 3-1/2" Wide x 3-1/2" Deep

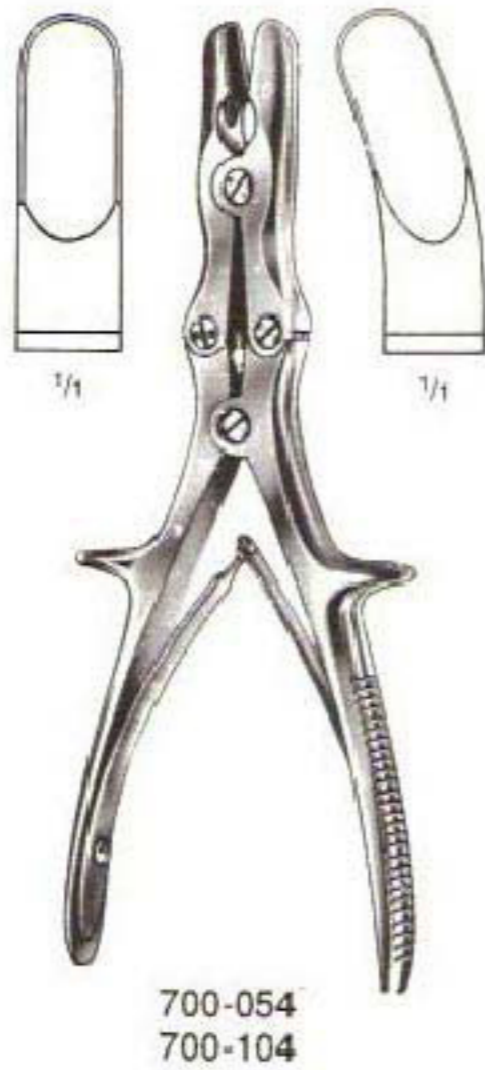

## ORTHOPEDIC INSTRUMENTS

- |         |   |
|---------|---|
| 700-054 | Stille-Luer Rongeur, Double Action, Straight, 8-3/4", 9x15mm Bite |
| 700-104 | Stille-Luer Rongeur, Double Action, Curved, 8-3/4", 9x15mm Bite   |
| 700-153 | Stille-Luer (Duckbill) Rongeur, Angled to Side, 9", 6x12mm Bite   |
| 700-302 | Leksell Rongeur, 9-1/2", Standard Curve, 3mm Bite                 |
| 700-308 | Leksell Rongeur, 9-1/2", Standard Curve, 8mm Bite                 |

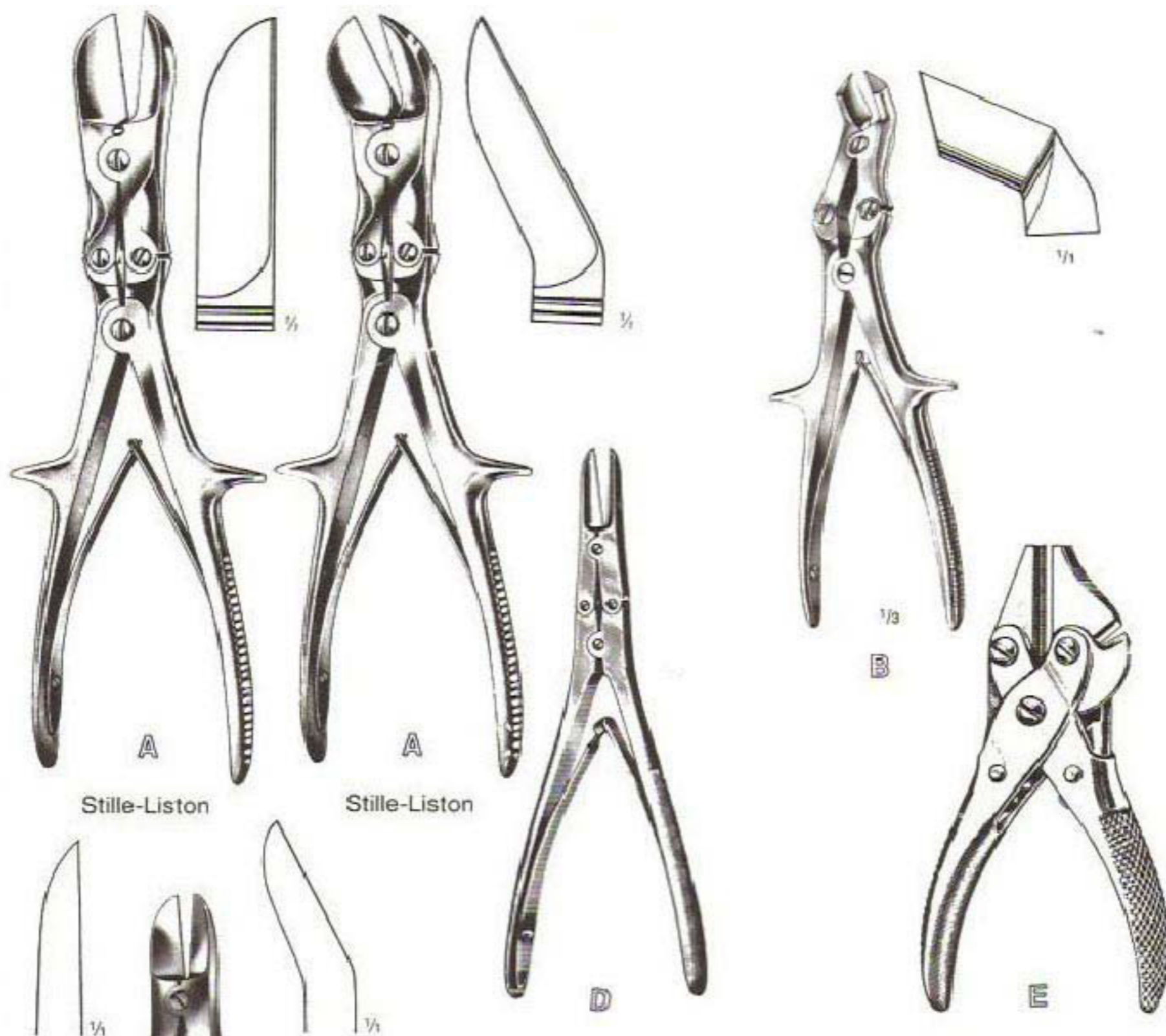

### ORTHOPEDIC INSTRUMENTS

- A** 700-450 STILLE-LISTON Bone Cutting Forceps, 10-3/4" (27.3 cm), straight  
700-468 STILLE-LISTON Bone Cutting Forceps, 10-3/4" (27.3 cm), curved
- B** 700-508 Stille-Horsley Bone Cutter 10 1/2", Angled Blades
- C** 700-757 Ruskin-Liston Bone Cutter, Straight, 7-1/2"  
700-765 Ruskin-Liston Bone Cutter, Angled, 7-1/2"
- D** 700-768 Ruskin Bone Cutting Forceps, 7-1/2" Straight  
Delicate Blades
- E** 706-585 Double Action Parallel Pliers and  
Wire Cutter 4-1/2" Nickel Plated





700-807  
700-815

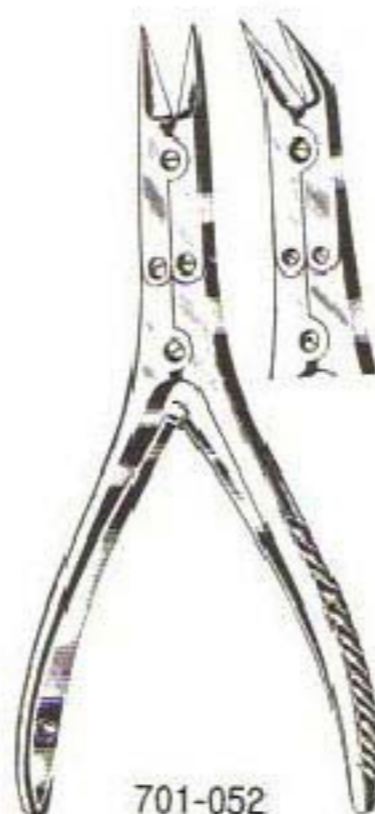

701-052  
701-060



701-230 701-245  
701-235 701-250  
701-240 701-300

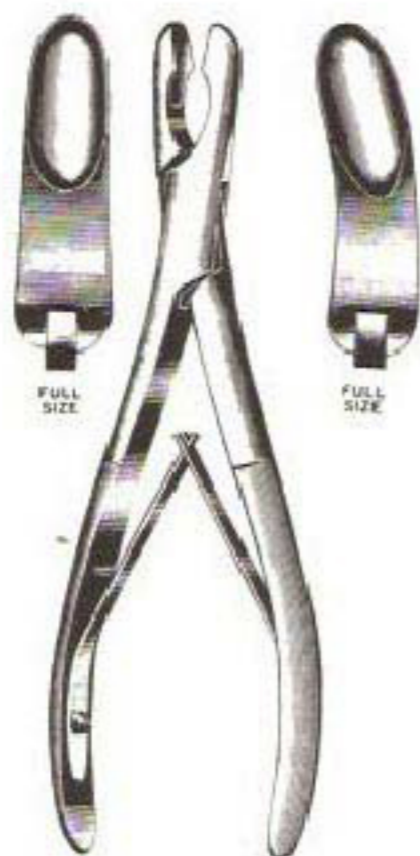

701-508  
701-516

## ORTHOPEDIC INSTRUMENTS

- 700-807 LISTON Bone Cutting Forceps, straight, 5-1/2" (14 cm)  
700-815 LISTON Bone Cutting Forceps, straight, 7-1/2" (19.1 cm)
- 701-052 RUSKIN Bone Splitting Forceps, 5-1/2" (14cm), straight  
701-060 RUSKIN Bone Splitting Forceps, 5-1/2" (14 cm), curved
- 701-230 RUSKIN Rongeur, double action, 7-1/4" (18.4 cm) long,  
Straight 7 mm bite jaws  
701-235 RUSKIN Rongeur, double action, 7-1/4" (18.4 cm) long,  
Straight 5 mm bite jaws  
701-240 RUSKIN Rongeur, double action, 6" (15.2 cm) long,  
Straight 3 mm bite jaws
- 701-245 RUSKIN Rongeur, double action, 7-1/4" (18.4 cm) long,  
Curved 7 mm bite jaws  
701-250 RUSKIN Rongeur, double action, 7-1/4" (18.4 cm) long,  
Curved 5 mm bite jaws  
701-300 RUSKIN Rongeur, double action, 6" (15.2 cm) long,  
Curved 3 mm bite jaws
- 701-508 Luer Rongeur, 7" (17.8 cm), straight jaws 8 mm bite  
701-516 Luer Rongeur, 7" (17.8 cm), curved jaws 8 mm bite

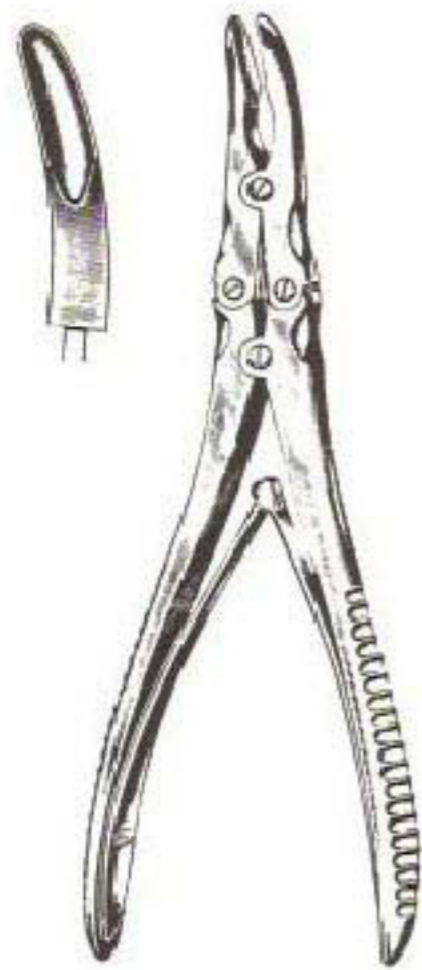

701-904



701-953

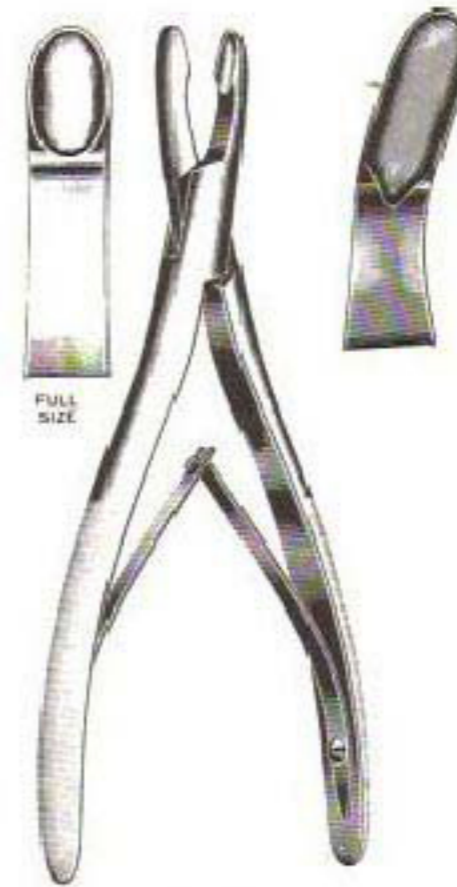

702-001



702-050

## ORTHOPEDIC INSTRUMENTS

- 701-904 ZAUFEL-JANSEN Rongeur, 7" (17.8 cm), D/A, Curved, 5 mm Bite
- 701-953 BEYER Rongeur, 7" (17.8 cm), Double Action, Curved, 3.5mm Bite
- 702-001 ADSON Cranial Rongeur, 8" (20.3 cm), Straight jaws 7 X 13 mm
- 702-002 ADSON Cranial Rongeur, 8" (20.3 cm), curved jaws 7 X 13 mm
- 702-050 BACON Rongeur, 8-1/4" (21 cm), angled on side, 5 mm bite



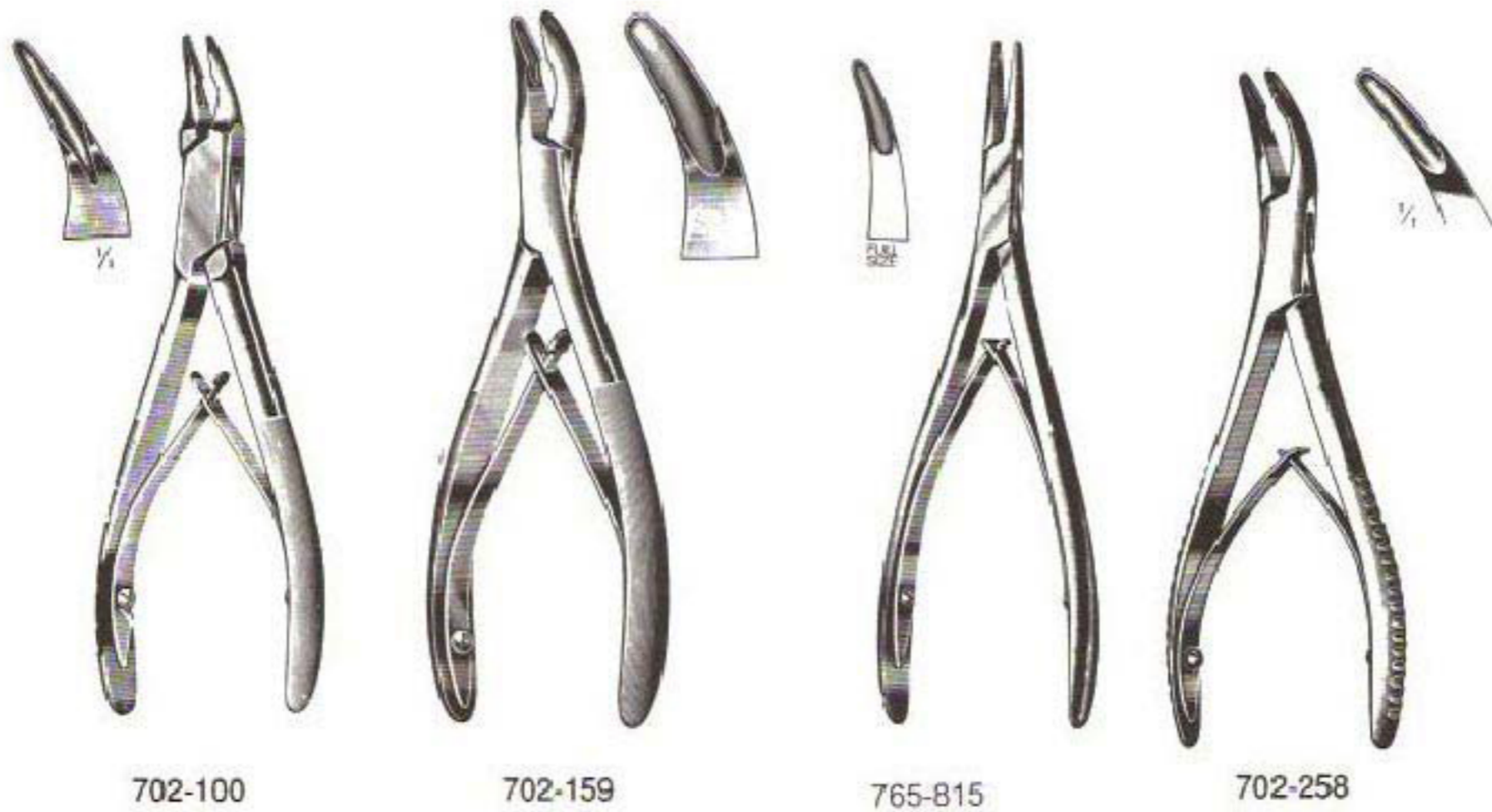

702-100

702-159

765-815

702-258

## ORTHOPEDIC INSTRUMENTS

- 702-100 REINER Surgery Rongeur, 7" (17.8 cm), beaks at 30 degree angle
- 702-159 MEAD Surgery Ronguer, 6-1/2" (16.5 cm), slightly curved beaks
- 702-258 HARTMAN Mastoid Rongeur, 5-3/4" (14.6 cm), strong curve
- 765-815 LEMPERT Rongeur, 6-1/4" (15.9 cm), curved, delicate, 2.5 mm bite

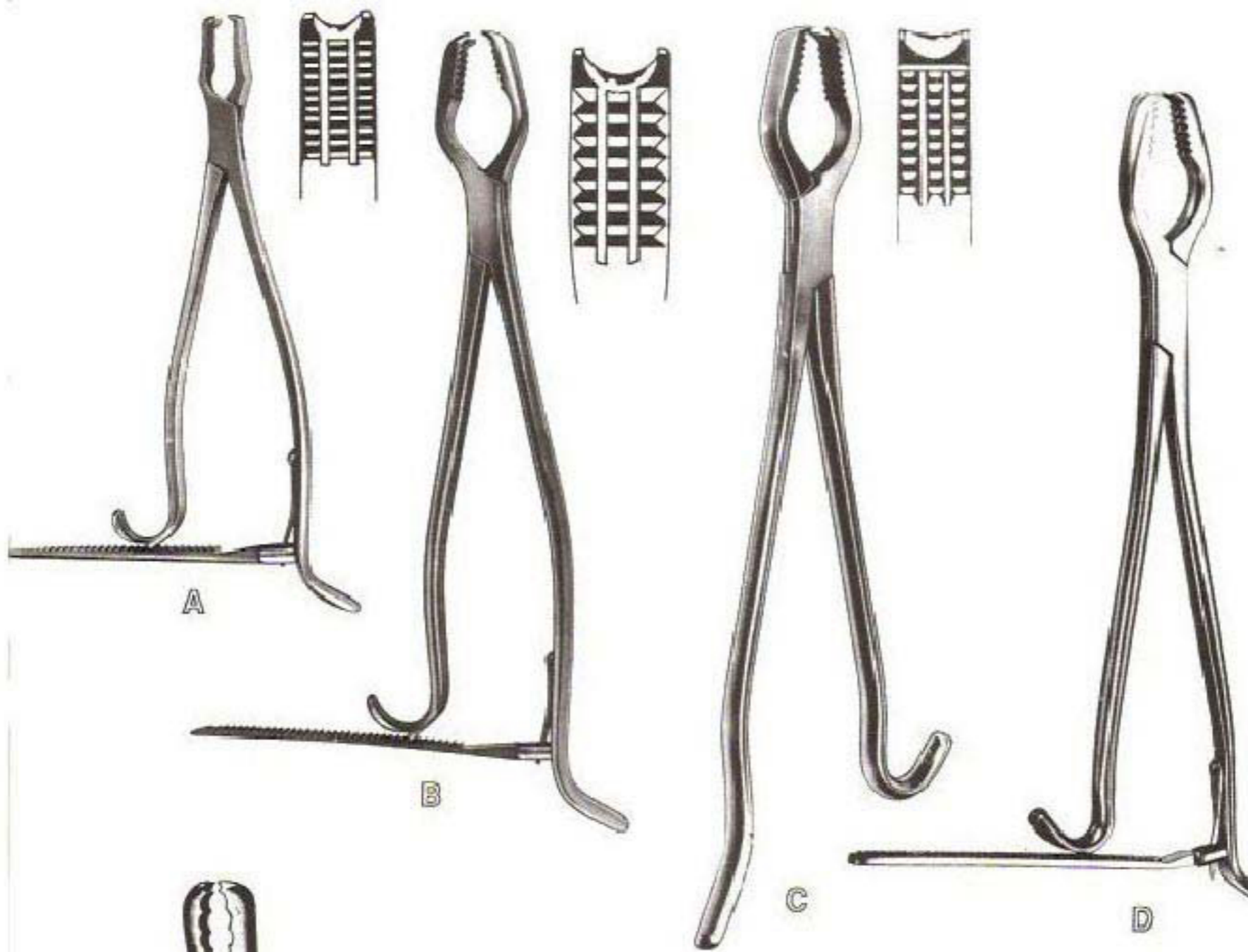

## ORTHOPEDIC INSTRUMENTS

- A** 702-357 Kern Bone Holding Forceps, with Ratchet, 6"
- B** 702-365 Kern Bone Holding Forceps, with Ratchet, 9 1/2"  
702-373 Kern Bone Holding Forceps, Plain, 9 1/2"
- C** 702-407 Lane Bone Holding Forceps, Plain, 13"
- D** 702-415 Lane Bone Holding Forceps, with Ratchet, 13"
- E** 702-418 Farabeuf-Lambotte Bone Holding Forceps, 10-1/4"



## ORTHOPEDIC INSTRUMENTS

- A** 702-456 Lewin Bone Holding Forceps, 7" Serrated
- B** 702-506 Lambotte Bone Holding Forceps, Small, 8-3/4"  
 702-514 Lambotte Bone Holding Forceps, Medium, 10-3/4"  
 702-522 Lambotte Bone Holding Forceps, Large, 12-3/4"
- C** 702-555 Parham-Martin Fracture Clamp, Small, 4-3/4"  
 702-563 Parham-Martin Bands Only
- D** 702-605 Lowman Bone Clamp, 5", Calibrated in 1/8",  
 1 x 2 Prong Jaws 3/4" Wide  
 702-613 Lowman Bone Clamp, 7", Calibrated in 1/8",  
 1 x 2 Prong Jaws 1" Wide  
 702-621 Lowman Bone Clamp, 8", Calibrated in 1/8",  
 1 x 2 Prong Jaws 1-1/4" Wide
- E** 702-625 Lambert-Lowman Bone Clamp, 7", 2 x 2 Prong Jaws 1" Wide  
 702-630 Lambert-Lowman Bone Clamp, 8", 2 x 2 Prong Jaws 1-3/8" Wide

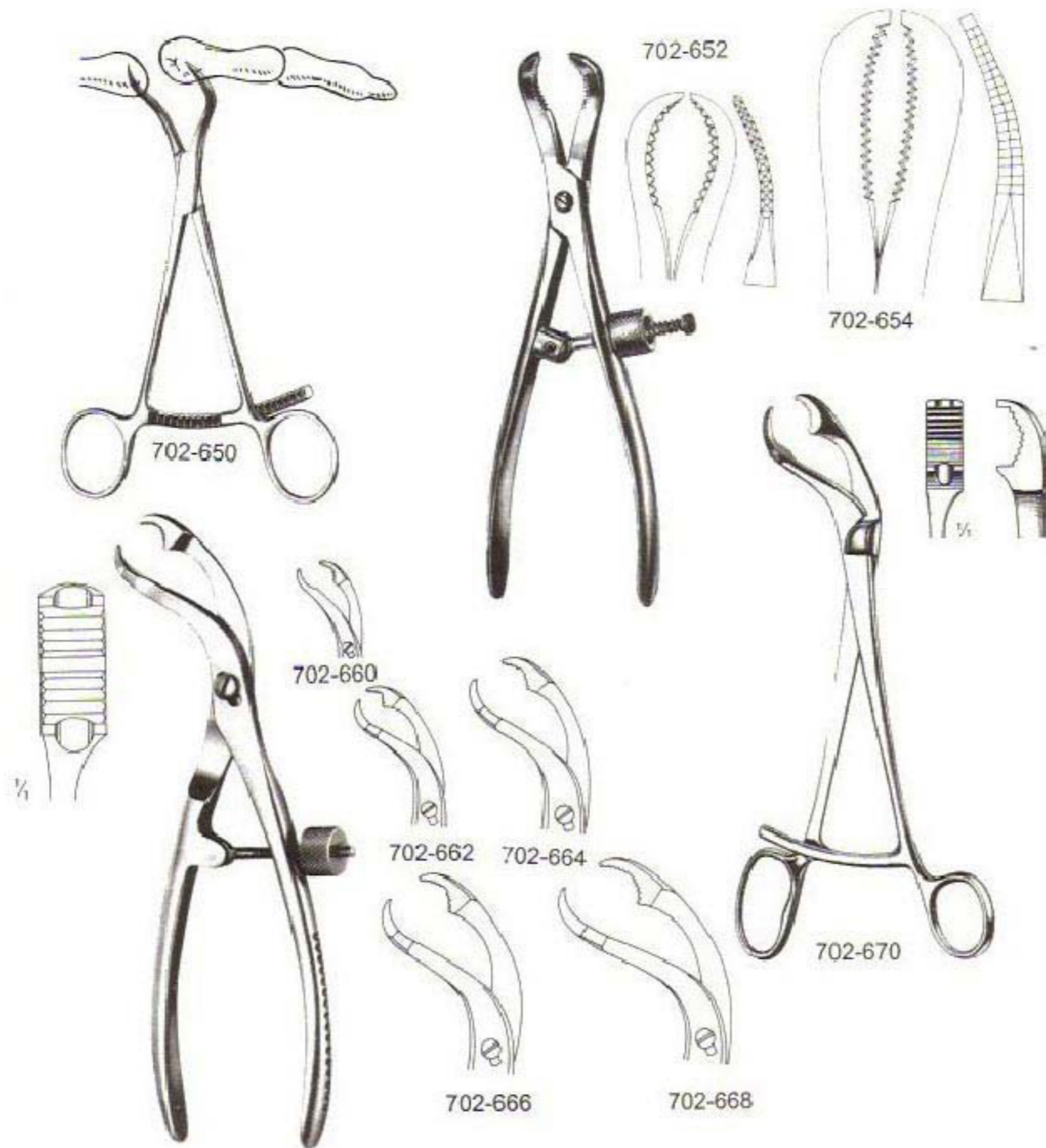

## ORTHOPEDIC INSTRUMENTS

- |         |  |
|---------|--|
| 702-650 | Bone Reduction Forceps, Curved, Pointed Tips, 5-1/2" (14cm)                      |
| 702-652 | Bone Reduction Forceps, Curved with Speed Lock, 6-1/4" (15.8cm)                  |
| 702-654 | Bone Reduction Forceps, Curved with Speed Lock, 9" (22.9cm)                      |
| 702-660 | VERBRUGGE Bone Holding Forceps, Self Centering with Speed Lock, 6" (15.2cm)      |
| 702-662 | VERBRUGGE Bone Holding Forceps, Self Centering with Speed Lock, 7-1/2" (19cm)    |
| 702-664 | VERBRUGGE Bone Holding Forceps, Self Centering with Speed Lock, 9-1/2" (24cm)    |
| 702-666 | VERBRUGGE Bone Holding Forceps, Self Centering with Speed Lock, 10-1/2" (26.7cm) |
| 702-668 | VERBRUGGE Bone Holding Forceps, Self Centering with Speed Lock, 11" (28cm)       |
| 702-670 | VERBRUGGE Bone Holding Forceps with Short Ratchet, 6-1/4" (15.8cm)               |

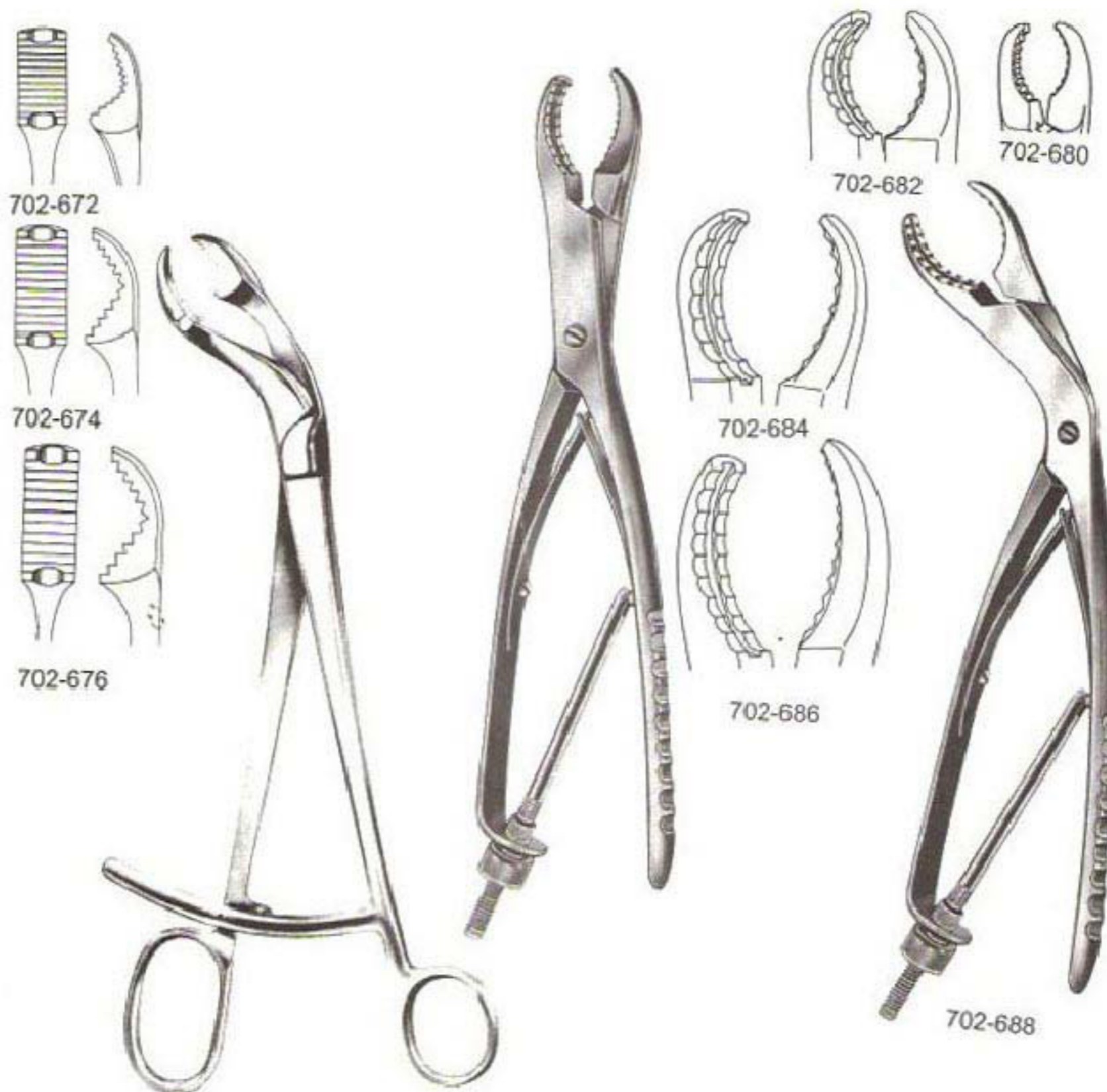

## ORTHOPEDIC INSTRUMENTS

- |         |  |
|---------|--|
| 702-672 | VERBRUGGE Bone Holding Forceps with Long Ratchet, 10" (25.4cm)                 |
| 702-674 | VERBRUGGE Bone Holding Forceps with Long Ratchet, 10-1/2" (26.7cm)             |
| 702-676 | VERBRUGGE Bone Holding Forceps with Long Ratchet, 11" (27.9cm)                 |
| 702-680 | ULRICH Self Retaining Forceps, Straight with Speed Lock, Mini, 7-1/4" (18.4cm) |
| 702-682 | ULRICH Self Retaining Forceps, Straight with Speed Lock, 9" (22.8cm)           |
| 702-684 | ULRICH Self Retaining Forceps, Straight with Speed Lock, 10" (25.4cm)          |
| 702-686 | ULRICH Self Retaining Forceps, Straight with Speed Lock, 11" (27.9cm)          |
| 702-688 | ULRICH Self Retaining Forceps, Angular with Speed Lock, 11" (27.9cm)           |



## ORTHOPEDIC INSTRUMENTS



- A** 702-753 Langenbeck Elevator, Narrow, 7"  
702-761 Langenbeck Elevator, Broad, 7"
- B** 702-803 Lane Elevator, Narrow, 7"  
702-811 Lane Elevator, Broad, 7"
- C** 702-852 M.G.H. Elevator, 6-1/2"
- D** 702-902 Farabeuf Raspatories, Straight, 6"  
702-910 Farabeuf Raspatories, Curved, 6"



- A 703-256
- 703-264
- 703-272
- 703-280
- 703-298
- B 703-553
- C 703-603
- 703-604
- D 703-652
- E 703-702
- F 703-850
- 703-868

**ORTHOPEDIC INSTRUMENTS**

KEY Periosteal Elevator, 7" (17.8 cm), 1/8" (.33 cm) wide  
 KEY Periosteal Elevator, 7" (17.8 cm), 1/4" (.64 cm) wide  
 KEY Periosteal Elevator, 7-1/2" (19.1 cm), 1/2" (1.3 cm) wide  
 KEY Periosteal Elevator, 8" (20.3 cm), 3/4" (19. cm) wide  
 KEY Periosteal Elevator, 8-1/4" (21 cm), 1" (2.5 cm) wide  
 MURPHY-LANE Bone Skid, 12" (30.5 cm)  
 SAYRE Periosteal Elevator, Sharp, 6-3/4" (17.1 cm)  
 SAYRE Periosteal Elevator, Blunt, 6-3/4" (17.1 cm)  
 SEDILLOT Periosteal Elevator, 7-1/2", blade 17 mm wide"  
 Bayonet Bone File, 9-3/4" (24.8 cm)  
 PUTTI Bone Rasp, 10-1/2" (26.7 cm), flat ends,  
 one side curved on flat, other one curved sideways  
 PUTTI Bone Rasp, 12" (30.5 cm),  
 round and half-round tapered, curved ends

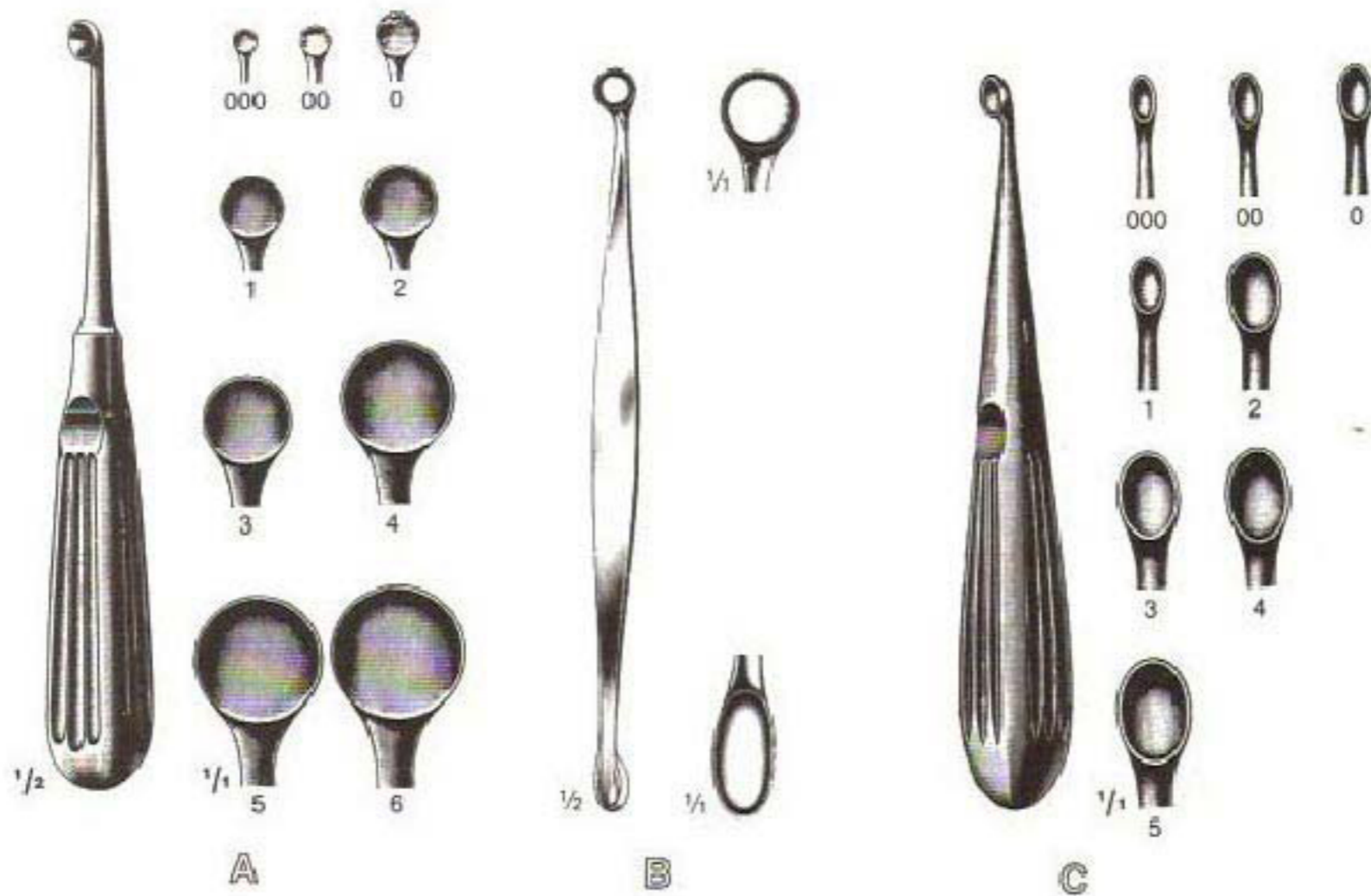

## ORTHOPEDIC INSTRUMENTS

<b>A</b>	703-983	Bruns Curette, #000, 6-3/4"	<b>C</b>	704-387	Hibbs-Spratt Curette, #000, 8"
	703-991	Bruns Curette, #00, 6-3/4"		704-395	Hibbs-Spratt Curette, #00, 8"
	704-007	Bruns Curette, #0, 6-3/4"		704-403	Hibbs-Spratt Curette, #0, 8"
	704-015	Bruns Curette, #1, 6-3/4"		704-411	Hibbs-Spratt Curette, #1, 8"
	704-023	Bruns Curette, #2, 6-3/4"		704-429	Hibbs-Spratt Curette, #2, 8"
	704-031	Bruns Curette, #3, 6-3/4"		704-437	Hibbs-Spratt Curette, #3, 8"
	704-049	Bruns Curette, #4, 6-3/4"		704-445	Hibbs-Spratt Curette, #4, 8"
	704-056	Bruns Curette, #5, 6-3/4"		704-452	Hibbs-Spratt Curette, #5, 8"
	704-064	Bruns Curette, #6, 6-3/4"		704-460	Hibbs-Spratt Curette, #6, 8"
<b>B</b>	704-155	Bone Curette, Double Ended, 5"			
	704-163	Bone Curette, Double Ended, 6-1/2"			





## ORTHOPEDIC INSTRUMENTS



STRATT (BRUN) BONE CURETTES 6 1/2" (16.5CM) OVAL CUPS				
<b>A</b>	704-470	Size 5/0	704-482	Size 2
	704-472	Size 4/0	704-484	Size 3
	704-474	Size 3/0	704-486	Size 4
	704-476	Size 2/0	704-488	Size 5
	704-478	Size 0	704-490	Size 6
	704-480	Size 1		
<b>B</b>	461-301	Martini Bone Curette 1 1/2" (14 cm), Double End 4 mm and 5 mm Round Cups		
<b>C</b>	704-495	Williger Bone Curette 5 1/2" (14 cm), Double End, 3 mm and 4 mm Oval Cups		



## ORTHOPEDIC INSTRUMENTS

- A** 704-500 Volkman Double End Curette, 5 ½" (14cm) Long, Oval Cups 5mm x 10mm and 8mm x 20mm
- B** 704-505 Volkman Double End Curette, 5" (12.7cm) Long, Oval Cup 6mm x 10mm and Round Cup 7mm Dia.
- C** 704-510 Volkman Double End Curette 6 ½" (16.5cm) Long, Oval Cup 8mm x 14mm and Round Cup 10mm Dia.
- D** 704-515 Bunnell Tendon Stripper 6" (15.2cm) 3mm  
704-520 Bunnell Tendon Stripper 6" (15.2cm) 4mm  
704-525 Bunnell Tendon Stripper 6" (15.2cm) 5mm  
704-530 Bunnell Tendon Stripper 6" (15.2cm) 6mm  
704-535 Bunnell Tendon Stripper 6" (15.2cm) 7mm

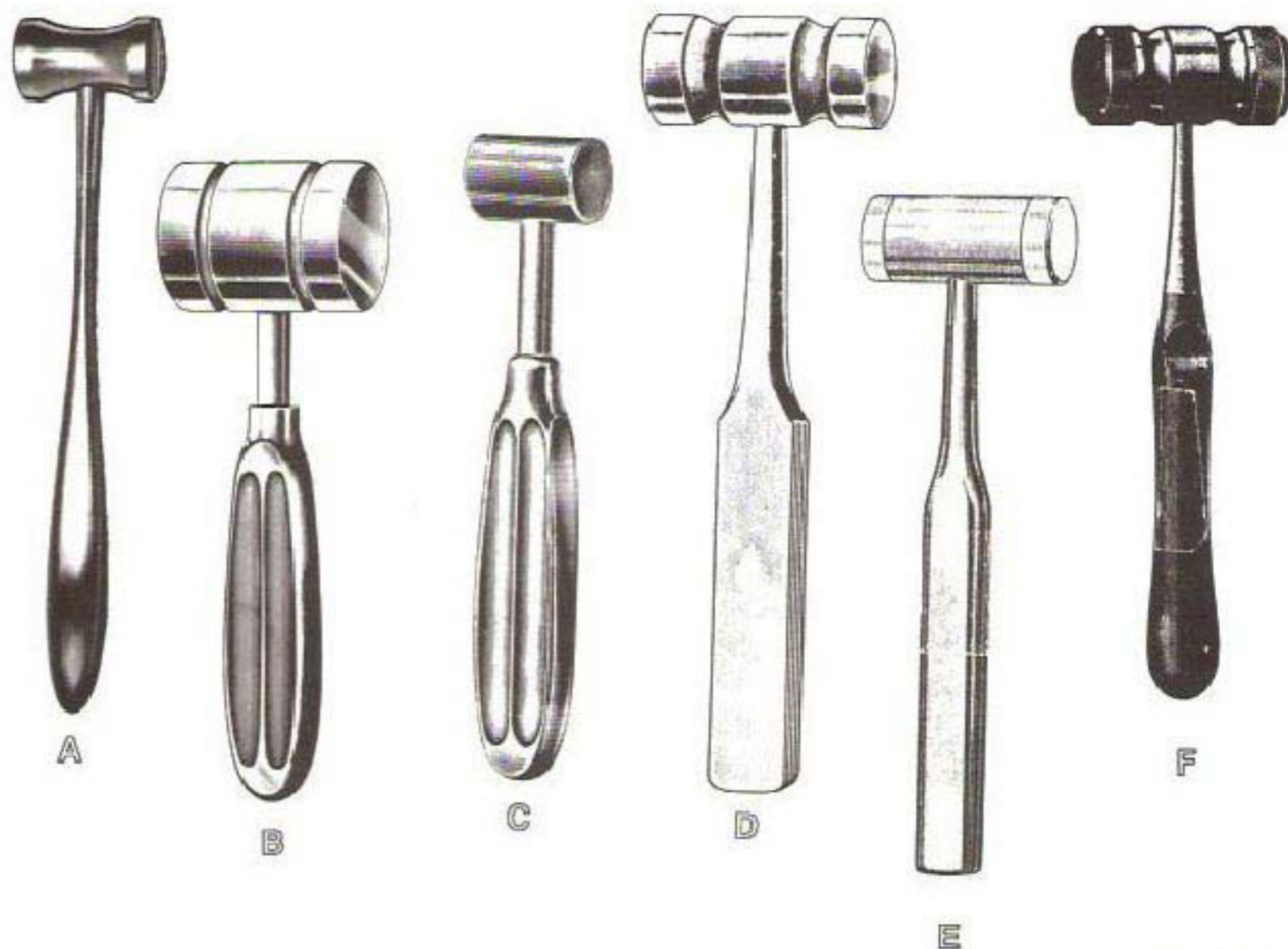

## ORTHOPEDIC INSTRUMENTS

- A** 704-650    Lucae Mallet 7 3/4", Head 9oz, Solid Stainless
- B** 704-675    Crane Mallet, Chrome, Small, 6-1/2"  
704-700    Crane Mallet, Chrome, Large, 6-1/2"
- C** 704-858    Gerzog Mallet 7-1/2", head 8 oz. lead filled with stainless jacket
- D** 704-958    Orthopedic Mallet, head 16 oz. solid, stainless, 11"  
704-959    Orthopedic Mallet, head 32 oz. solid, stainless, 11"
- E** 704-960    Mallet, 7-1/2" Lightweight 7.5 oz. - Stainless Head, 1" Diameter  
With 2 Replaceable Nylon Caps
- F** 704-962    Mead Mallet, 7-1/2" with Replaceable Nylon Caps  
Weight: 12 oz. Head Diameter: 20mm
- G** 824-003    Hajek Mallet, 16mm Bronze Head, 8 oz., 8-1/4"





## MALLETS



- A** 704-964 Williger Bone Mallet, Lead Filled Head, 350grams – 13 ozs, 30mm Diam., (24cm) – 9 ½"
- B** 704-966 Mallet, Solid, 490 Grams – 1lb, 2 ozs, 28mm Diam., (23cm) – 9"
- C** 704-968 Heath Mallet Heavyweight, w/Anodized Aluminum Handle, Weight: 28 ozs, Head Diameter: 40mm, 7 ½"
- D** 704-970 Kirk Mallet, Weight: 24 ozs, Head Diameter: 1 ½". 7 ¾"
- E** 704-972 Post Mortem Hammer 9 ½" (24.1cm), w/Hook Handle



## ORTHOPEDIC INSTRUMENTS

### MALLETS

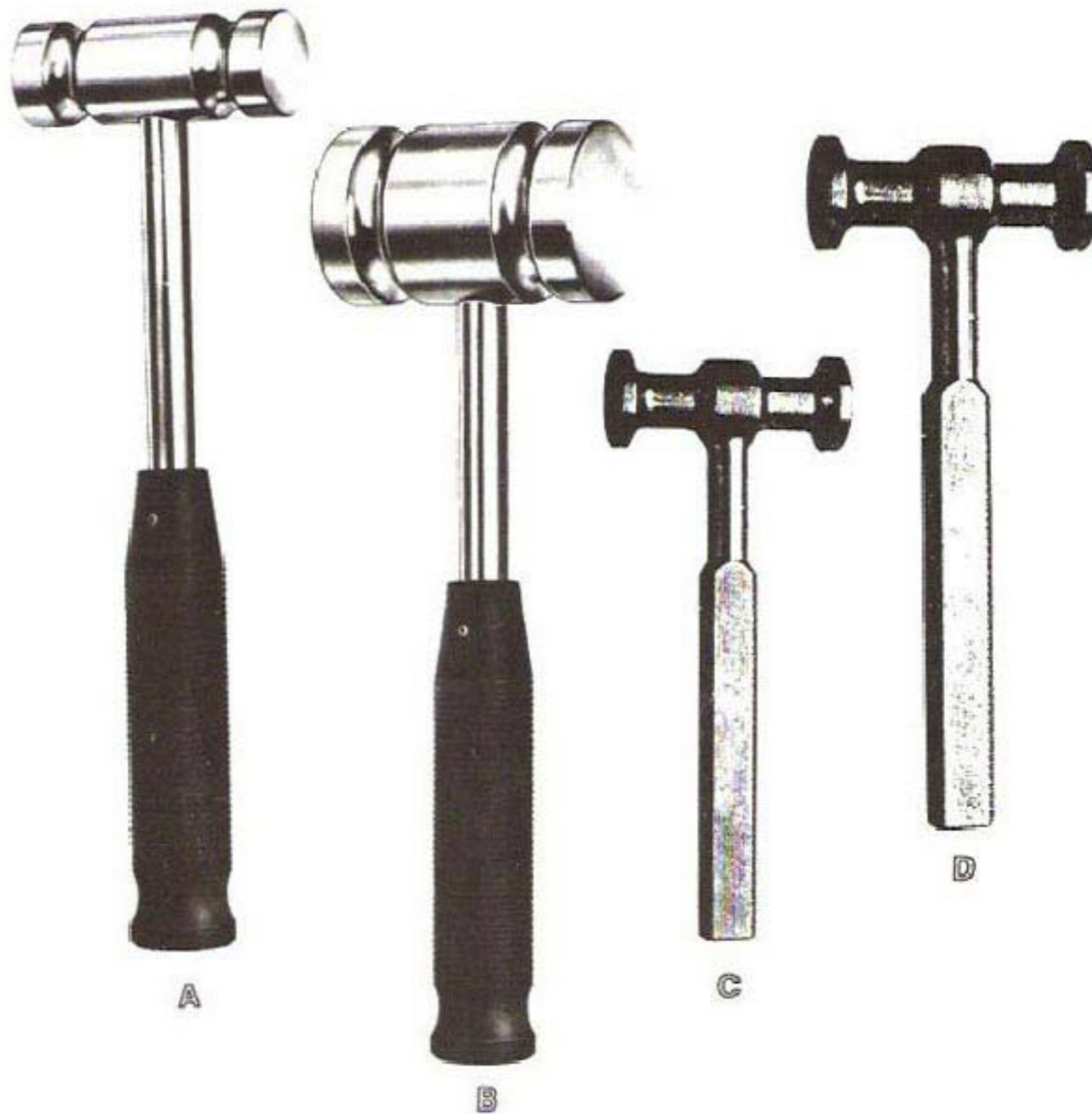

- A** 704-974 Phenolic Handle Mallet, Weight: 1lb, Head Diameter: 1 1/4", 11"
- B** 704-976 Phenolic Handle Mallet, Weight: 2lbs, Head Diameter: 1 3/4", 11"
- C** 704-978 Orthopedic Mallet, Head 1 3/16" (3cm) Diameter, Weight: 2lbs Overall Length 7 3/16" (18.3cm)
- D** 704-980 Orthopedic Mallet, Head 1 4/5" (3.8cm) Diameter, Weight: 2lbs Overall Length 7 -9/16" (19.3cm)



## ORTHOPEDIC INSTRUMENTS

- |          |         |                                      |
|----------|---------|--------------------------------------|
| <b>A</b> | 705-004 | Hoke Osteotome, 1/8", 3mm, 5-1/2"    |
|          | 705-012 | Hoke Osteotome, 3/16", 5mm, 5-1/2"   |
|          | 705-020 | Hoke Osteotome, 1/4", 7mm, 5-1/2"    |
|          | 705-038 | Hoke Osteotome, 5/16", 8.5mm, 5-1/2" |
|          | 705-046 | Hoke Osteotome, 3/8", 10mm, 5-1/2"   |
|          | 705-053 | Hoke Osteotome, 1/2", 12mm, 5-1/2"   |
| <b>B</b> | 705-301 | Lambotte Osteotome, 1/4", 6mm, 9"    |
|          | 705-319 | Lambotte Osteotome, 1/2", 12mm, 9"   |
|          | 705-327 | Lambotte Osteotome, 3/4", 19mm, 9"   |
|          | 705-335 | Lambotte Osteotome, 1", 25mm, 9"     |
|          | 705-343 | Lambotte Osteotome, 1-1/2", 37mm, 9" |
| <b>C</b> | 705-400 | U.S.A. Pattern Chisel, 6mm, 6-1/4"   |
|          | 705-418 | U.S.A. Pattern Chisel, 12mm, 6-1/4"  |
|          | 705-426 | U.S.A. Pattern Chisel, 18mm, 6-1/4"  |
| <b>D</b> | 705-509 | U.S.A. Pattern Gouge, 6mm, 6-1/4"    |
|          | 705-517 | U.S.A. Pattern Gouge, 10mm, 6-1/4"   |
|          | 705-525 | U.S.A. Pattern Gouge, 14mm, 6-1/4"   |

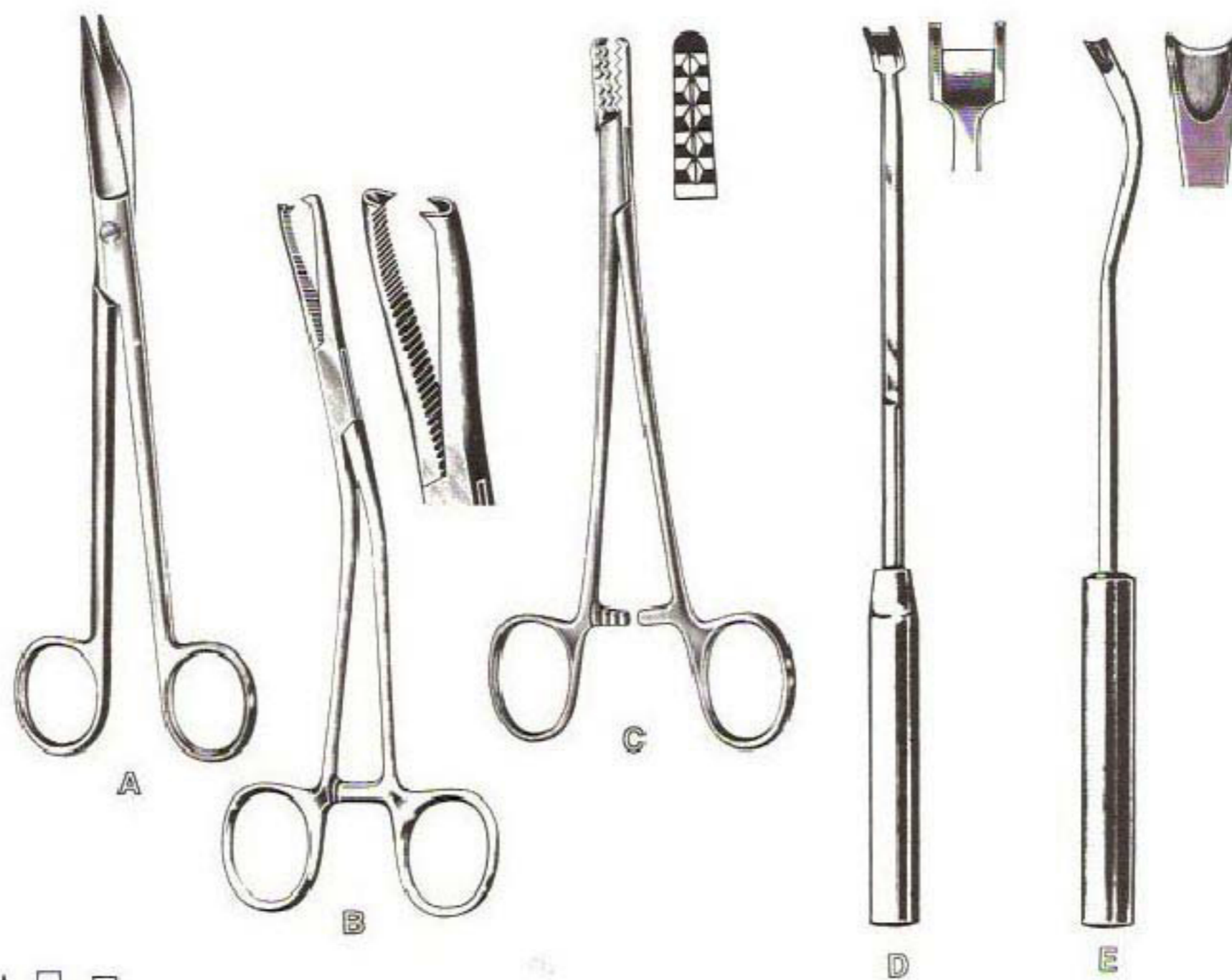

## ORTHOPEDIC INSTRUMENTS

- A** 705-558 Martin Cartilage Scissors, Serrated Blades, 8"
- 705-574 Martin Cartilage Scissors, Smooth Blades, 8"
- B** 705-608 Dingman Cartilage Clamp, 7 1/2"
- C** 705-657 Martin Cartilage Clamp, 7 1/2"
- D** 705-707 Lowe-Breck Cartilage Knife, 10 1/2" (26.7 cm) Straight Edge with Guards
- E** 705-710 Downing Cartilage Knife, 10" (25.4 cm), Concave Edge with Guards
- F** 705-715 Smillie Cartilage Knife, 6 3/4" (17.1 cm), Straight Edge
- 705-720 Smillie Cartilage Knife, 6 3/4" (17.1 cm), Left
- 705-725 Smillie Cartilage Knife, 6 3/4" (17.1 cm), Right

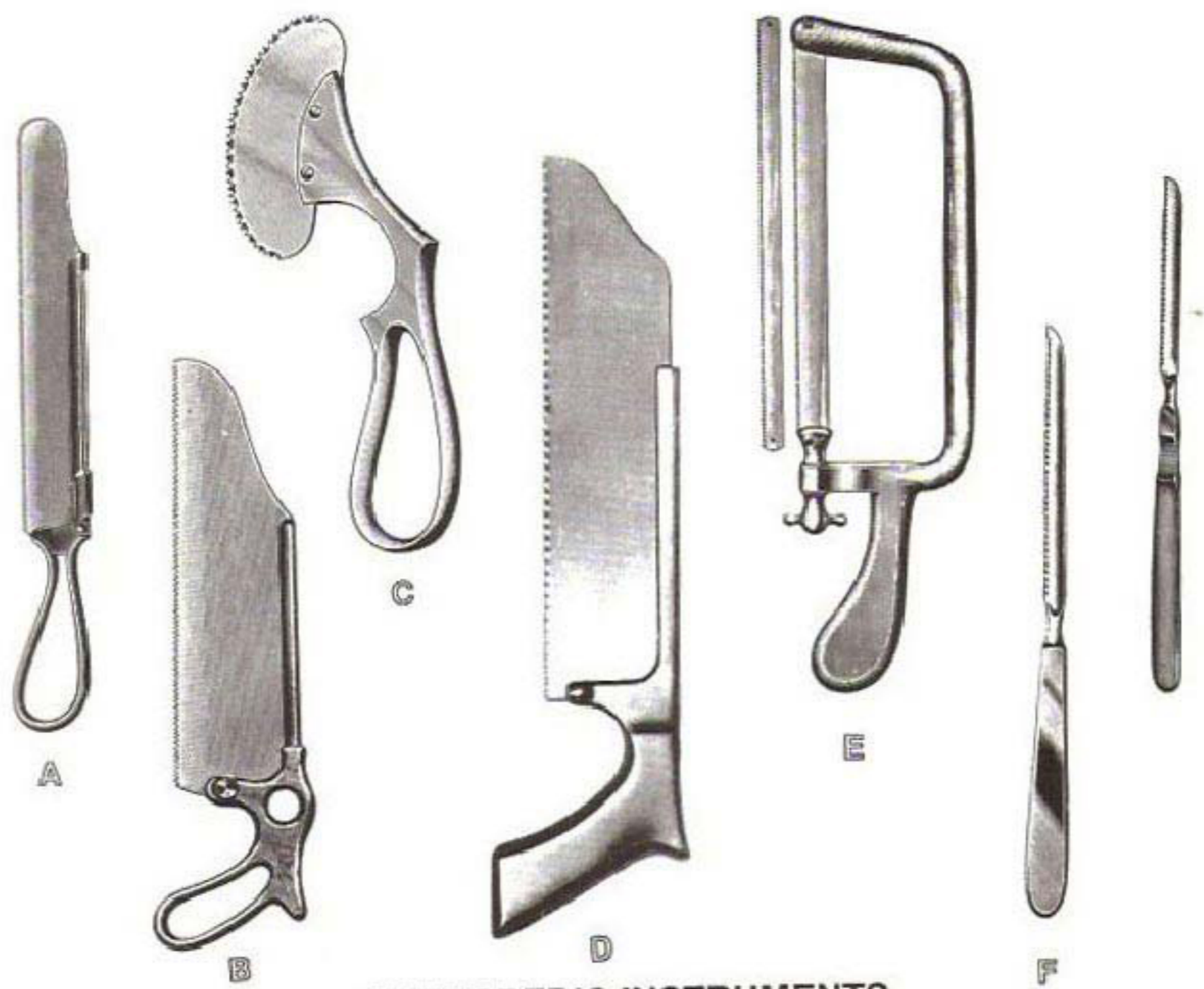

### ORTHOPEDIC INSTRUMENTS

- |          |         |  |
|----------|---------|--|
| <b>A</b> | 705-806 | Charriere Bone Saw 8" Blade, Chrome Handle, 11 ½"                              |
|          | 705-810 | Charriere Bone Saw 9 ½" Blade, Chrome Handle, 14"                              |
| <b>B</b> | 705-812 | Satterlee Bone Saw 9" Blade, Chrome Handle, 12"                                |
|          | 705-814 | Satterlee Bone Saw, Blade Only 9"  |
| <b>C</b> | 705-820 | Engel Cast Saw, 6" (15.2cm)  |
| <b>D</b> | 705-824 | Satterlee Bone Saw 12" (30.5cm), Light Metal Handle<br>with Stainless Blades   |
|          | 705-825 | Blade for No. 705-824 Satterlee Saw  |
| <b>E</b> | 705-830 | Charriere Bone Saw 14" (35.6cm) with one each 12mm and 18mm<br>Stainless Blade |
|          | 705-832 | 12mm Wide Blade for No. 705-830 Saw  |
|          | 705-834 | 18mm Wide Blade for No. 705-830 Saw  |
| <b>F</b> | 705-836 | Langenbeck Metacarpel Saw 9 ¼" (23.5cm), Blade<br>4 ½" (11.4cm) Long           |
| <b>G</b> | 705-840 | Fine Bone Saw 6" (15.2cm), Blade 2" (5.1cm)                                    |





1/2

706-051



706-101  
706-119  
706-127



706-259



706-300



706-309



706-505

## ORTHOPEDIC INSTRUMENTS

- 706-051 "Diamond" Pin and Wire Cutter, 6 1/2" (16.5cm), cuts up to 2mm, 5/8 Diameter Hard Wire Stainless
- 706-101 Gigli Saw 12" (30.5cm), Standard Twisted Wire Type
- 706-119 Gigli Saw 20" (50.5cm), Standard Twisted Wire Type
- 706-127 Gigli Saw 30" (76.2cm), Standard Twisted Wire Type
- 706-259 Gigli-Strully Saw Handle, Loop Grip, Rigid, with Snap Lock
- 706-300 Gigli-Strully Saw Handle, T-Shape, Turnable, with Snap Lock
- 706-309 Gigli Saw Handle, Standard Pattern, T-Shape, Turnable
- 706-505 Fine Canulated Pin and Wire Cutter, 7 1/2" (19.1cm), End Cutting up to 3.2mm (1/4") Soft Wire or 1.6mm (1/16") Hard Wire



## LEAD HANDS



706-507



706-508

## LEAD HANDS

- |         |                          |
|---------|--------------------------|
| 706-507 | Lead Hand, 14", Adult    |
| 706-508 | Lead Hand, 9-1/2", Child |



## TUNGSTEN CARBIDE

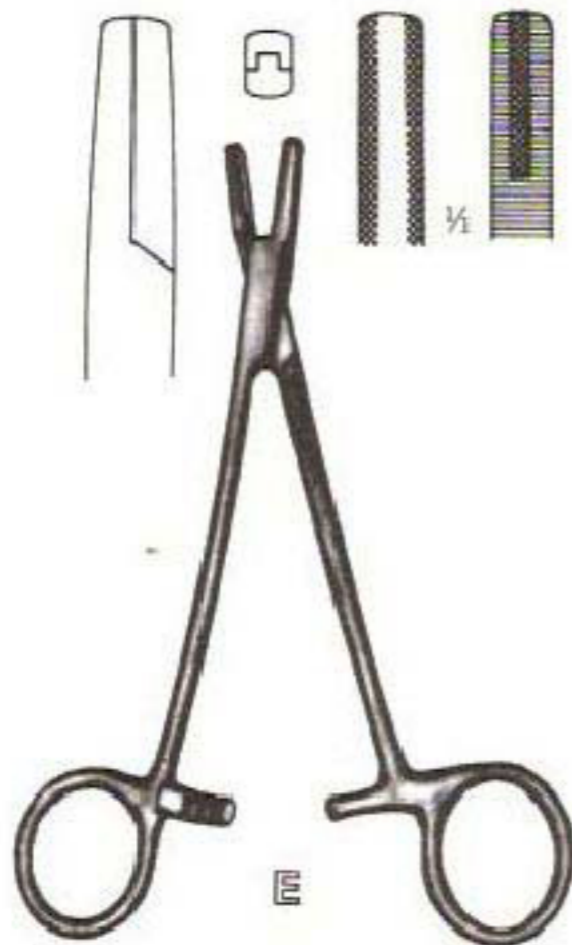
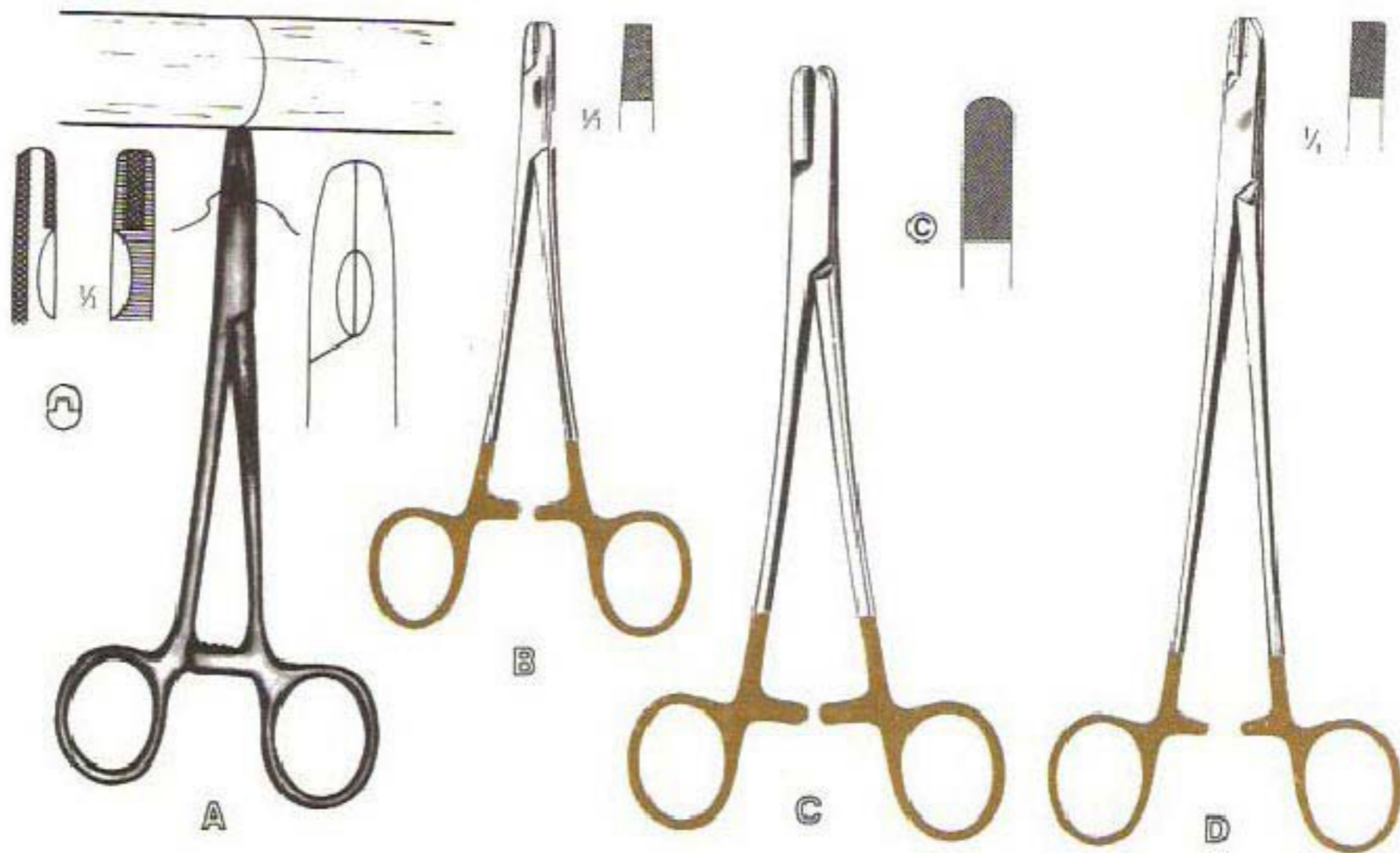

## WIRE TIGHTENERS AND TWISTERS

- 706-510    **A** Wire Twister and Tightener, 6-1/4"
- 706-515    **B** Wire Twisting Forceps, 6", Carbide Jaws
- 706-520    **C** Wire Twisting Forceps, 7-1/4", Carbide Jaws
- 706-525    **D** Wire Twisting Forceps, 8", Carbide Jaws
- 706-530    **E** Wire Pulling Forceps, 6-1/2"

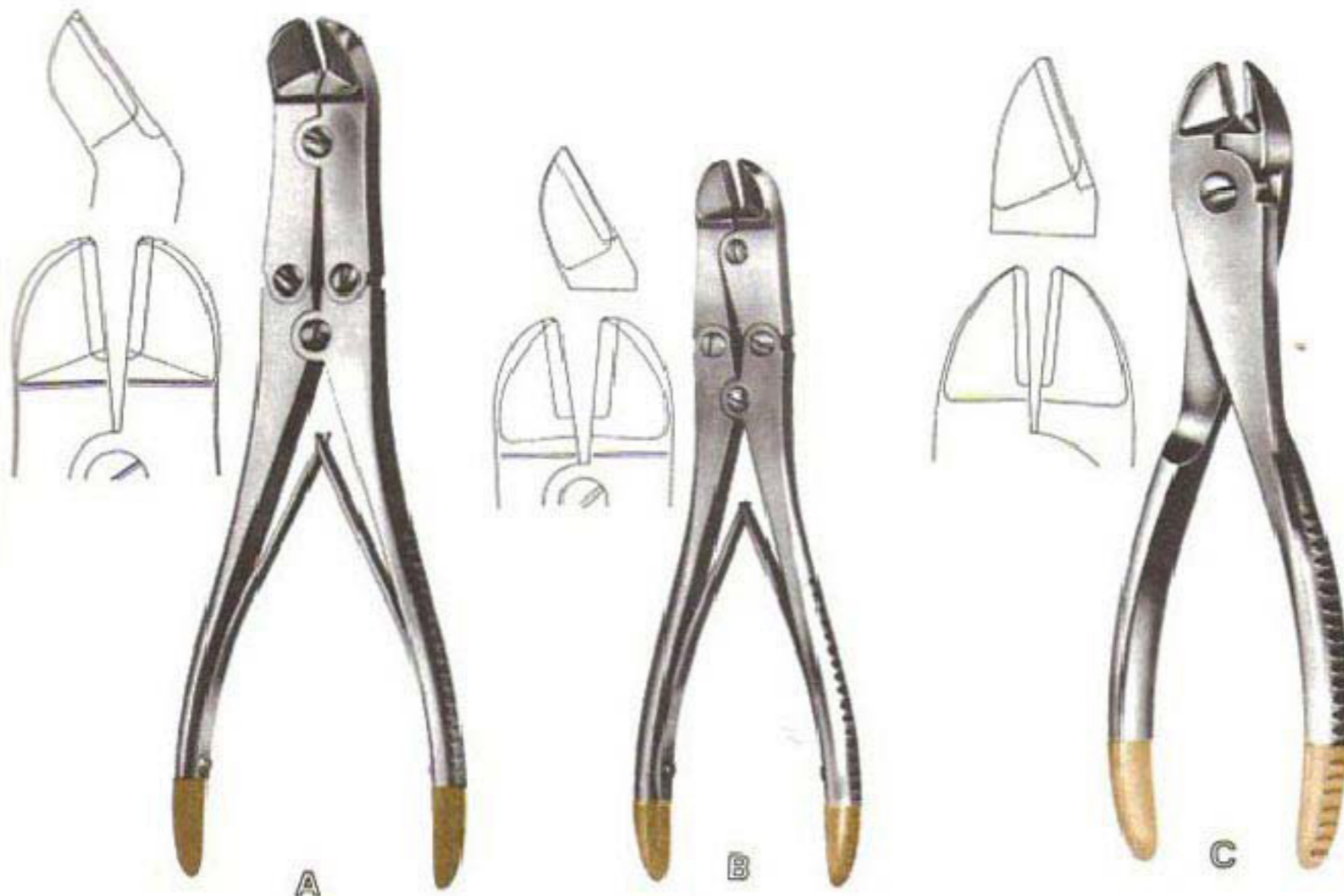

### WIRE and PIN CUTTERS with Tungsten Carbide Inserts

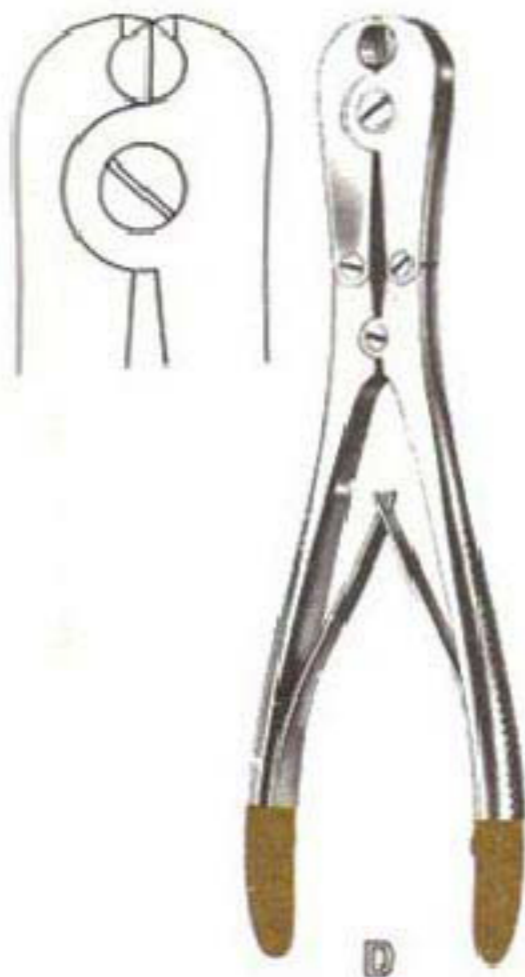

- A** 706-535 Double Action Wire Cutter, 8 ½", Angled Side Cutting, with Tungsten Carbide Inserts
- 706-537 Double Action Wire Cutter, 9 ¼", Angled Side Cutting, with Tungsten Carbide Inserts
- B** 706-540 Double Action Wire Cutter, 7" Angled Side Cutting, with Tungsten Carbide Inserts
- 706-542 Double Action Wire Cutter, 9" Straight Jaws Side Cutting, with Tungsten Carbide Inserts
- C** 706-545 Side Cutter, 7", Side Cutting with Tungsten Carbide Inserts
- D** 706-550 Front and Side Wire Cutter, 7" Front and Side Cutting with Tungsten Carbide Inserts, Double Action



### PLIERS AND PLUG CUTTERS

- A** 706-555 Slip Joint Pliers
- B** 706-560 Double Action Wire Extraction Pliers, 7" 2mm Delicate Jaws, Carbide Insert
- 706-565 Double Action Wire Extraction Pliers 7" 4mm Jaws, Carbide
- 706-570 Double Action Wire Extraction Pliers 7" 6mm Jaws, Carbide Inserts
- C** 706-580 Flat Nose Pliers, 5-1/2", Broad 5mm Tip
- D** 706-585 Double Action Parallel Pliers and Wire Cutter 4-1/2", Nickel Plated
- E** 706-590 Locking Pliers, 8" Self-Locking
- F** 706-595 Needle Nose Locking Pliers, 9-1/2", Self-Holding with Groove

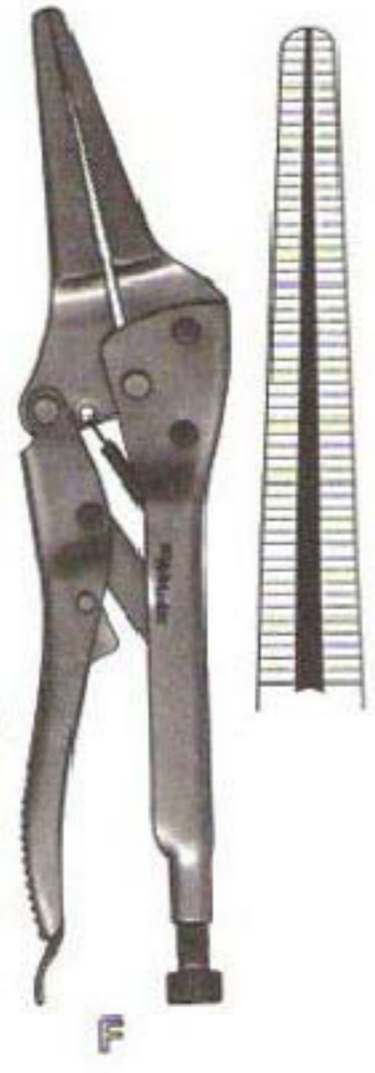



## PIN and ROD END CUTTER

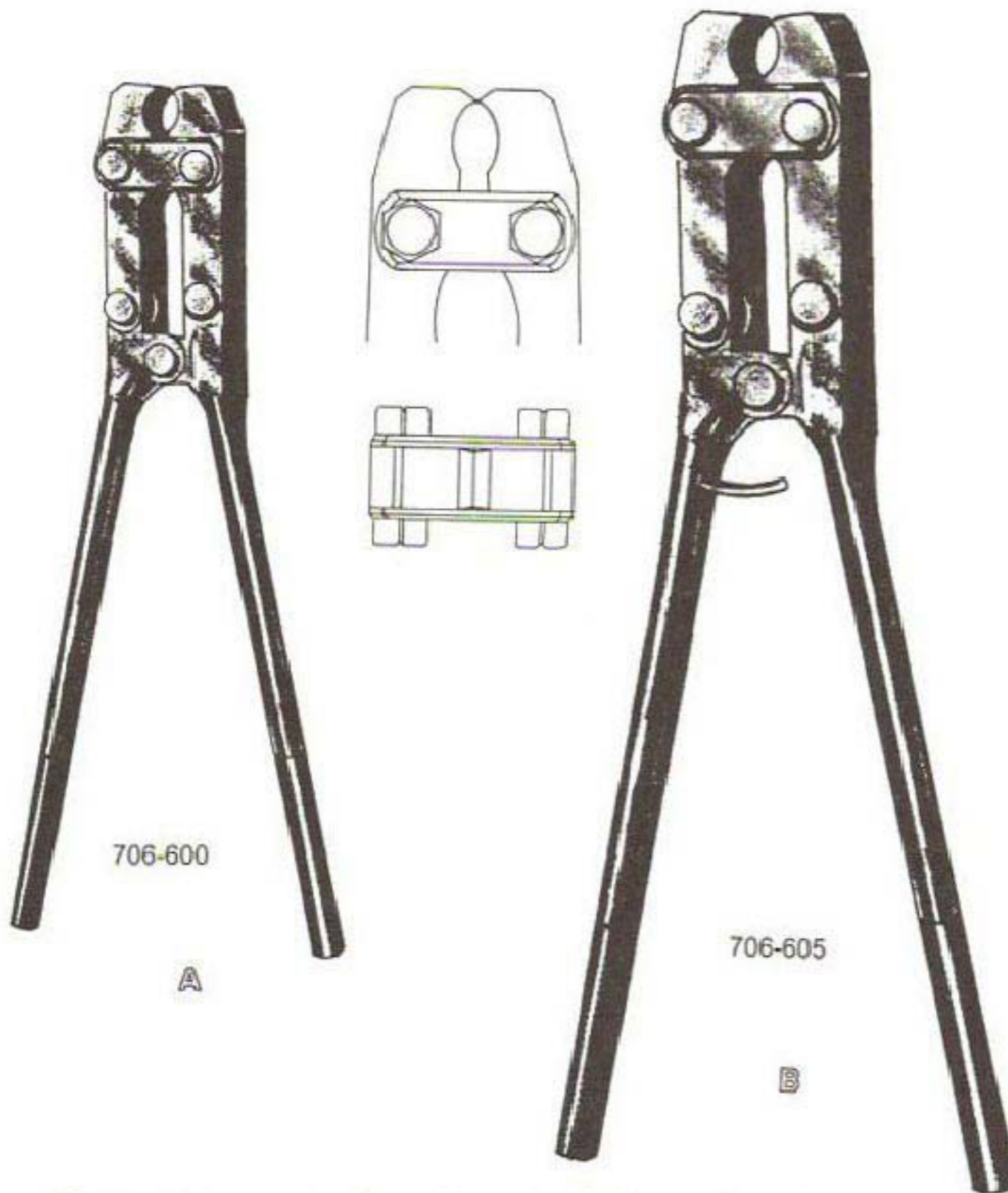

Cutter for cutting of Kirschner wires.

### PIN and ROD END CUTTER

- A** 706-600 Pin Cutter, Small, 10" (25.4 cm) end cutting, Max. Cap. 1/8" (3mm)
- B** 706-605 Pin Cutter, Medium, 16" (40.6 cm) end cutting, Max. Cap. 3/16" (4.7mm)



**PIN and ROD SIDE CUTTERS  
With Tungsten Carbide Inserts**



**WIRE CUTTERS**

for pins up to  $\varnothing$  6 mm

Cutter for cutting of Kirschner wires.  
Steinmann Pins up to 6 mm dia. hard

**PIN and ROD SIDE CUTTERS**

- 706-606 Pin Cutter, 17-3/4" (45cm) side cutting, TC Jaws
- 706-607 Pin Cutter, 22" (56cm) side cutting, TC Jaws
- 706-608 Pin Cutter, 17-3/4" (47cm) side cutting,  
TC Jaws with Adj. Bolt
- 706-609 Pin Cutter, 22" (56cm) side cutting,  
TC Jaws with Adj. Bolt

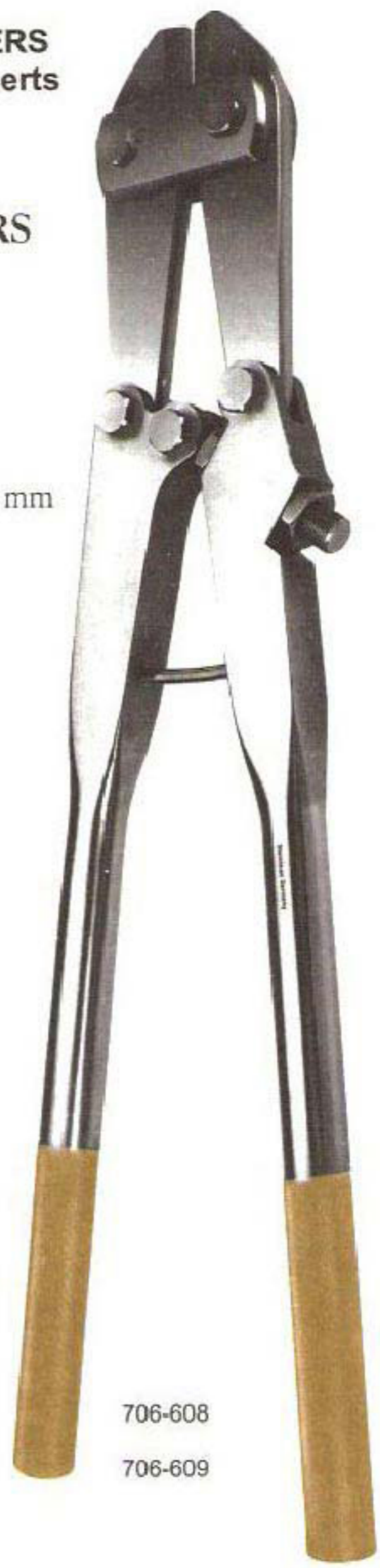



## WIRE CUTTERS and PLIERS

- 706-051 "Diamond" Pin and Wire Cutter, 6 ½"
- 706-610 Flat Nose Pliers, 6" Delicate, 2mm Tip
- 706-615 Flat Nose Pliers, 5 ½"
- 706-620 Flat Nose Pliers, 6 ½" 3.5mm Tip  
Combination Pliers and Cutter
- 706-625 Pin and Wire Cutter, 6 ½"





### NEEDLE NOSE PLIERS – SEIZING FORCEPS

- A** 706-635 Double Action Flat Nose Pliers, 6 ¼"
- B** 706-640 Needle Nose Pliers with Groove, 5 ½" Delicate
- C** 706-645 Flat Nose Seizing Forceps, 15cm 6"
- D** 706-650 Needle Nose Pliers, 5 ½"



## NEURO-SURGICAL INSTRUMENTS LAMINECTOMY RONGEURS

SCHLESINGER CERVICAL RONGEURS, THIN TIPS, 6" SHAFT

Up-Bite		Down-Bite	
720-005	3mm	720-009	3mm
720-007	5mm	720-010	5mm

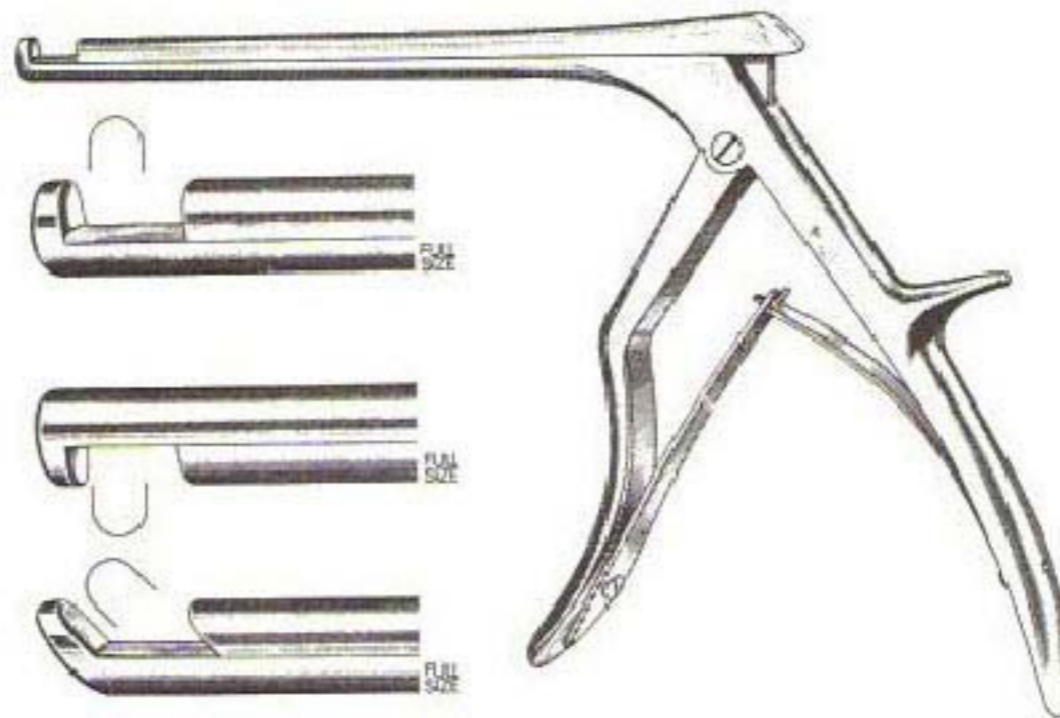

## NEURO-SURGICAL INSTRUMENTS LAMINECTOMY RONGEURS

### SPURLING-KERRISON CERVICAL RONGEURS

Up-Bite	Down-Bite	40° Forward Angle Up-Bite
6" Shaft	6" Shaft	6" Shaft
720-018 3mm	720-021 3mm	720-023 3mm
720-020 5mm	720-022 5mm	720-024 5mm
8" Shaft	8" Shaft	8" Shaft
720-025 3mm	720-028 3mm	720-030 3mm
720-026 5mm	720-029 5mm	720-032 5mm

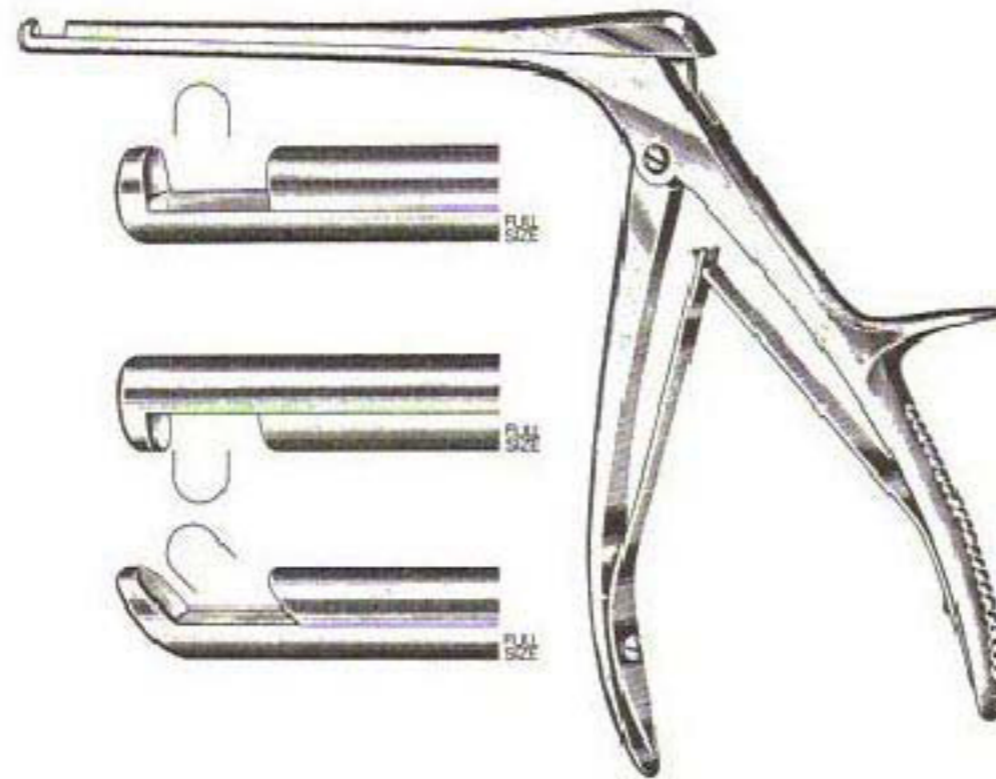

## NEURO-SURGICAL INSTRUMENTS LAMINECTOMY RONGEURS

### LOVE-KERRISON CERVICAL RONGEURS

Up-Bite		Down-Bite		40° Forward Angle Up-Bite	
6" Shaft		6" Shaft		6" Shaft	
720-033	3mm	720-035	3mm	720-037	3mm
720-034	5mm	720-036	5mm	720-038	5mm
7" Shaft					
720-039	3mm				
720-040	5mm				

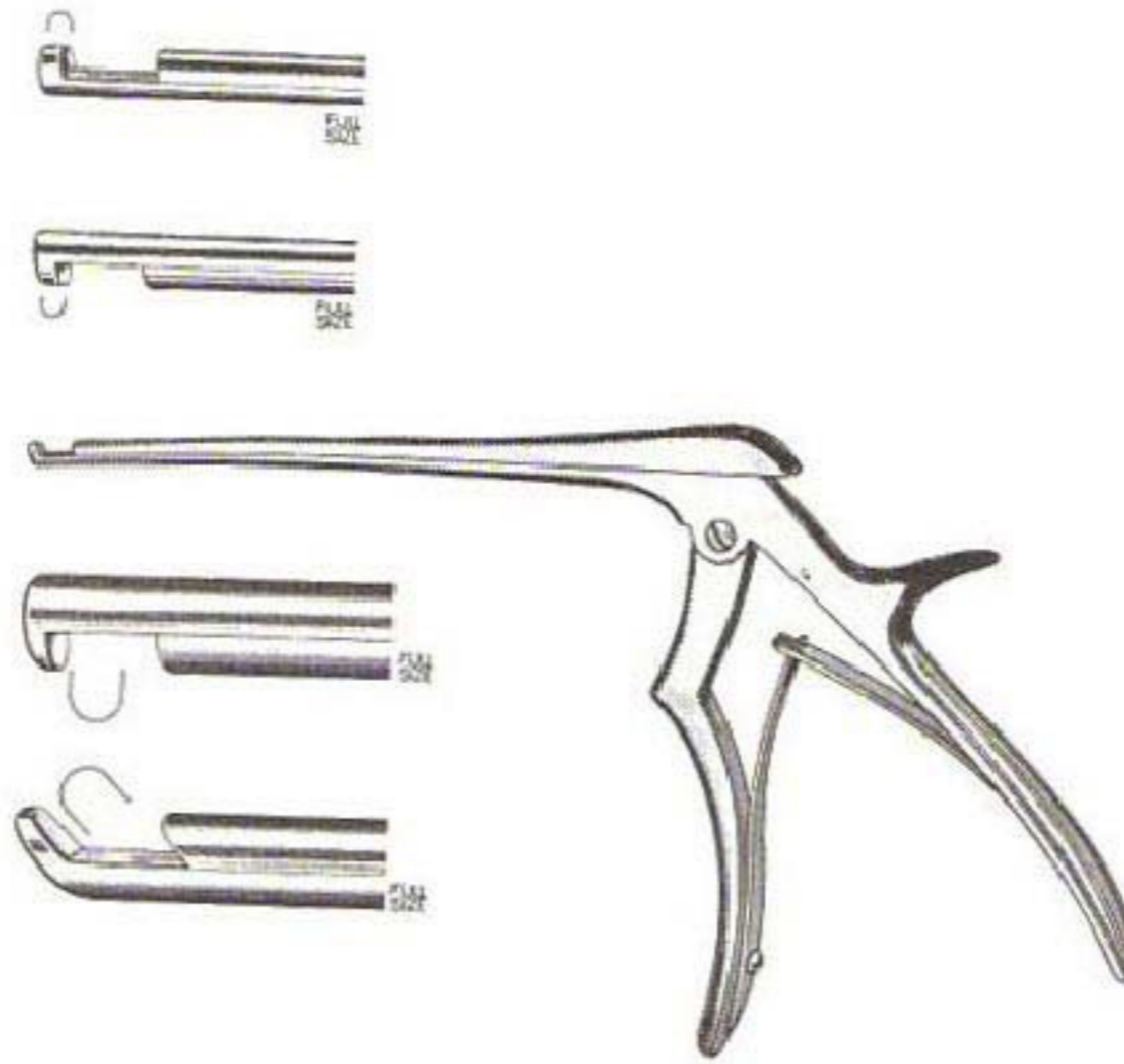

## NEURO-SURGICAL INSTRUMENTS LAMINECTOMY RONGEURS

CROWN-KERRISON CERVICAL RONGEURS 7" SHAFT, IMPROVED HANDLE

Up-Bite		Down-Bite		40° Forward Angle Up-Bite	
720-043	2mm	720-046	2mm	720-049	2mm
720-044	3mm	720-047	3mm	720-050	3mm
720-045	4mm	720-048	4mm	720-051	4mm

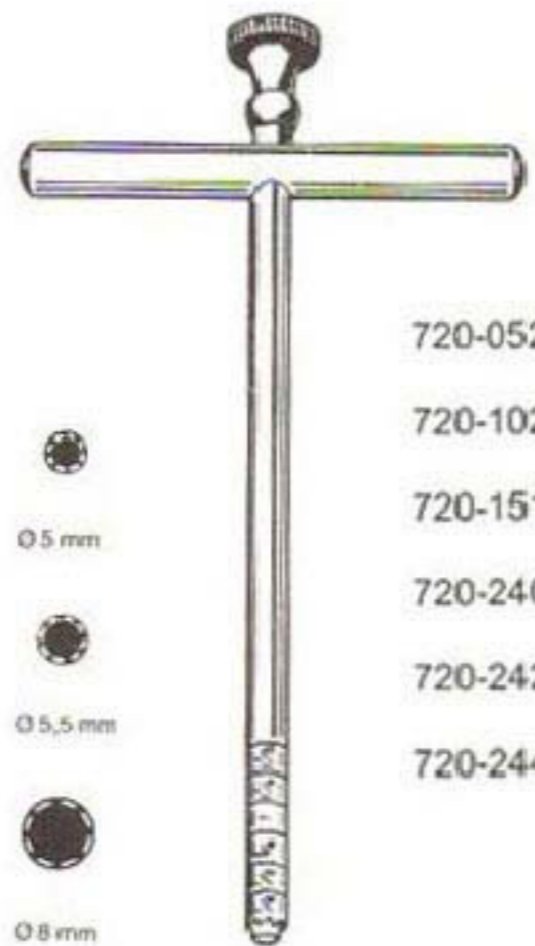

- 720-240  0.5 mm
- 720-242  0.5.5 mm
- 720-244  0.8 mm

## NEUROLOGICAL INSTRUMENTS

- 720-052 BAILEY-GIGLI Saw Guide, 12" (30.5 cm), flexible
- 720-102 ADSON Drill Guide and Dura Protector
- 720-151 DAVIS Guide for Gigli saws, 8" (20.3 cm)
- 720-240 MICHELE Trephine, 6-1/4" (15.9 cm) shaft, 3/16" (.47 cm)  
O.D. graduated 1/4" (.64 cm) To 1-1/4" (3.2 cm)
- 720-242 MICHELE Trephine, 6-1/4" (15.9 cm) shaft, 7/32" (.56 cm)  
O.D. graduated 1/4" (.64 cm) To 1-1/4" (3.2 cm)
- 720-244 MICHELE Trephine, 6-1/4" (15.9 cm) shaft, 5/16" (.79 cm)  
O.D. graduated 1/4" (.64 cm) To 1-1/4" (3.2 cm)

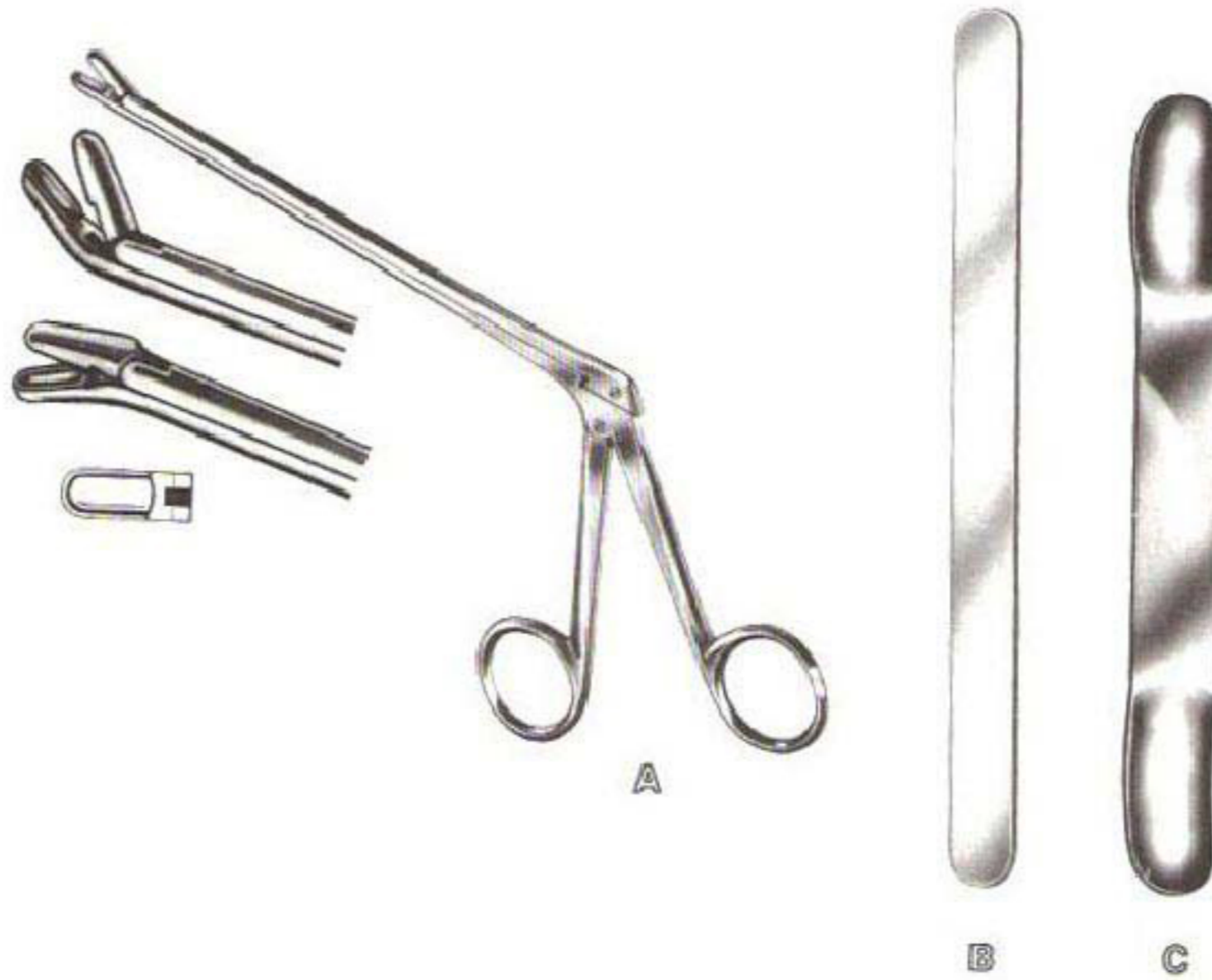

## NEUROSURGICAL INSTRUMENTS

- |          |         |   |
|----------|---------|---|
| <b>A</b> | 720-160 | Cloward Pituitary Rongeur, 6x10 mm Cup Jaws 6" (15.2 cm) Shanks, Straight               |
|          | 720-162 | Cloward Pituitary Rongeur, 6x10 mm Cup Jaws 6" (15.2 cm) Shanks, Up-Angle               |
|          | 720-164 | Cloward Pituitary Rongeur, 6x10 mm Cup Jaws 6" (15.2 cm) Shanks, Down-Angle             |
| <b>B</b> | 720-166 | Davis Spatula 7" (17.8 cm) x 1/2" (1.3 cm) Nickel Silver, Malleable                     |
|          | 720-168 | Davis Spatula 7" (17.8 cm) x 3/4" (1.9 cm) Nickel Silver, Malleable                     |
| <b>C</b> | 720-170 | Cushing Spatula Spoon 6 3/4" (17.1 cm), Spoon Ends 1/2" (1.3 cm) and 3/4" (1.7 cm) Wide |
|          | 720-172 | Cushing Spatula Spoon 7 3/4" (19.7 cm), Spoon Ends 3/4" (1.9 cm) and 1" (2.5 cm) Wide   |

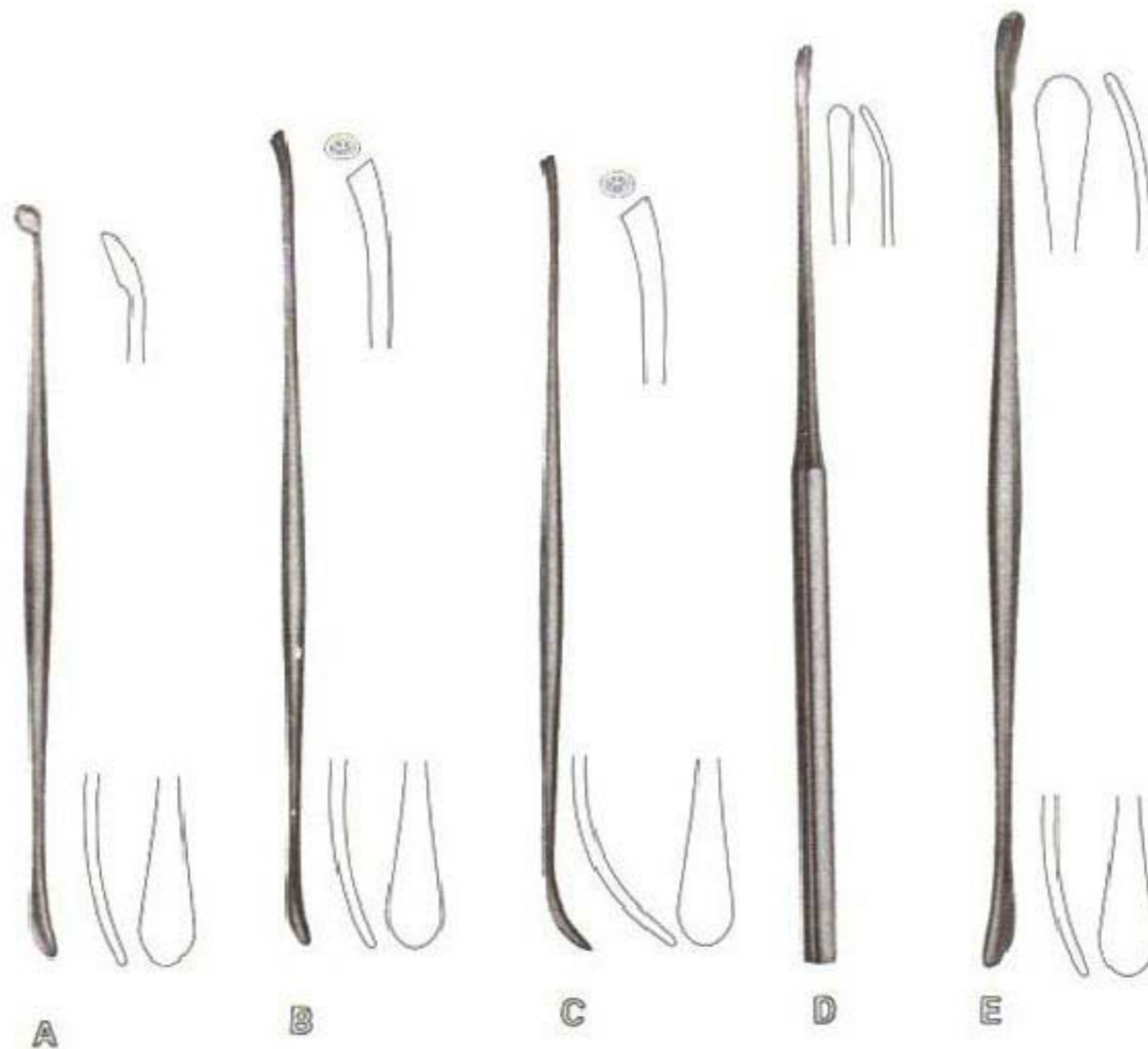

## NEUROSURGICAL INSTRUMENTS

- A** 720-700 Penfield Dissector 7  $\frac{1}{4}$ " (18.4 cm), Double End, 6mm Sharp Cup and 6 mm Blunt Dissector
- B** 720-705 Penfield Dissector 7  $\frac{3}{4}$ " (19.7 cm), Double End, Wax Packer and 6 mm Blunt Dissector, Slightly Curved
- C** 720-710 Penfield Dissector 7  $\frac{1}{2}$ " (19.1 cm) Double End, Wax Packer and 6mm Blunt Dissector, Fully Curved
- D** 720-715 Penfield Dissector, 8  $\frac{3}{4}$ " (22.2 cm) Single End, Light Pattern 3mm Blunt Dissector, Slightly Curved
- E** 720-720 Penfield Dissector, 11  $\frac{1}{2}$ " (29.2 cm), Double End, Slightly Curved Blunt Dissector Blades 7mm and 8 mm wide





### NEUROLOGICAL INSTRUMENTS

- A 720-458 Frazier Dura Separator, 6"
- B 720-508 Sachs Nerve Separator and Spatula, 8-1/4"
- C 720-557 Adson Dura Hook, Sharp, 8"
- D 720-565 Adson Dura Hook, Blunt, 8"
- E 720-607 Graham Dura Hook, Blunt, 6-3/4"
- F 720-656 Sachs Dura Hook, Blunt, 7-1/2"





A



B



C



D



E



F

## NEUROLOGICAL INSTRUMENTS

- A 720-805 Adson Aneurysm Needle, 9"
- B 720-854 Dandy Nerve Hook, Angled, 9"  
720-862 Dandy Nerve Hook, Straight, 9"  
720-870 Dandy Nerve Hook, Angled Right, 9"
- C 720-904 Cushing Angular Hook, 7-1/2"
- D 720-953 Nerve Hook Plain, 7-1/2"
- E 721-001 Smithwick Nerve Hook and Dissector, 12"
- F 721-100 Crile Hook and Dissector, 12"



721-159



721-209



721-506  
721-510

## NEUROLOGICAL INSTRUMENTS

721-159 Strully Dissecting Scissors, Probe Tip, Curved, 8"

721-209 Frazier (Taylor) Scissors, Probe Tips, 6"

721-506 Dandy (Kolodney) Scalp Hemostats, 5-1/2"

721-510 Dandy (Kolodney) Scalp Hemostats, 1 x 2 Teeth, 5-1/2"



## NEUROSURGICAL INSTRUMENTS

- |          |         |   |
|----------|---------|---|
| <b>A</b> | 722-360 | Scoville Clip Applying Forceps, 6" (15.2 cm), Shaft                           |
| <b>B</b> | 721-520 | Cushing Pituitary Rongeur, (2x10 mm) Cup Jaws, 7" (17.8 cm) Shank Straight    |
| <b>C</b> | 721-525 | Cushing Pituitary Rongeur (2x10 mm) Cup Jaws, 7" (17.8 cm) Shank Curved Up    |
| <b>D</b> | 721-530 | Cushing Pituitary Rongeur (2x10 mm) Cup Jaws, 7" (17.8 cm) Shank Curved Down  |
|          | 721-535 | Spurling Pituitary Rongeur (4x10 mm) Cup Jaws, 7" (17.8 cm) Shank Curved Down |

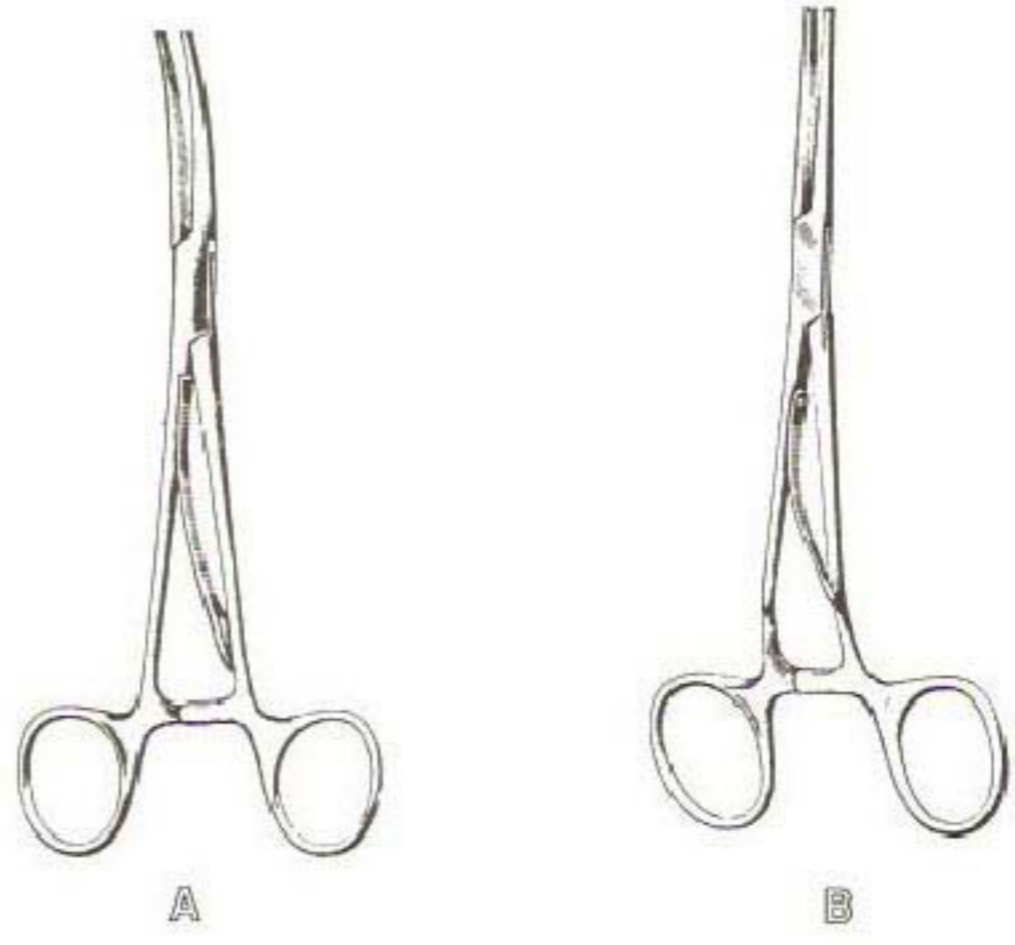

## NEUROLOGICAL INSTRUMENTS

- A** 722-005 McKenzie Clip Applying Forceps, Straight Handle, Curved Jaws, 6"
- B** 722-007 McKenzie Clip Applying Forceps, Curved Handle, Straight Jaws, 6"



## NEUROLOGICAL INSTRUMENTS

- |          |         |  |
|----------|---------|--|
| <b>A</b> | 722-009 | Smithwick Clip Applying Forceps 9", Curved Jaws<br>Straight Handles    |
| <b>B</b> | 722-017 | Smithwick Clip Applying Forceps 10 ½", Curved Jaws<br>Straight Handles |
| <b>C</b> | 722-157 | Sweet Clip Applying Forceps 10 ½", Straight Jaws<br>Angled Shanks      |

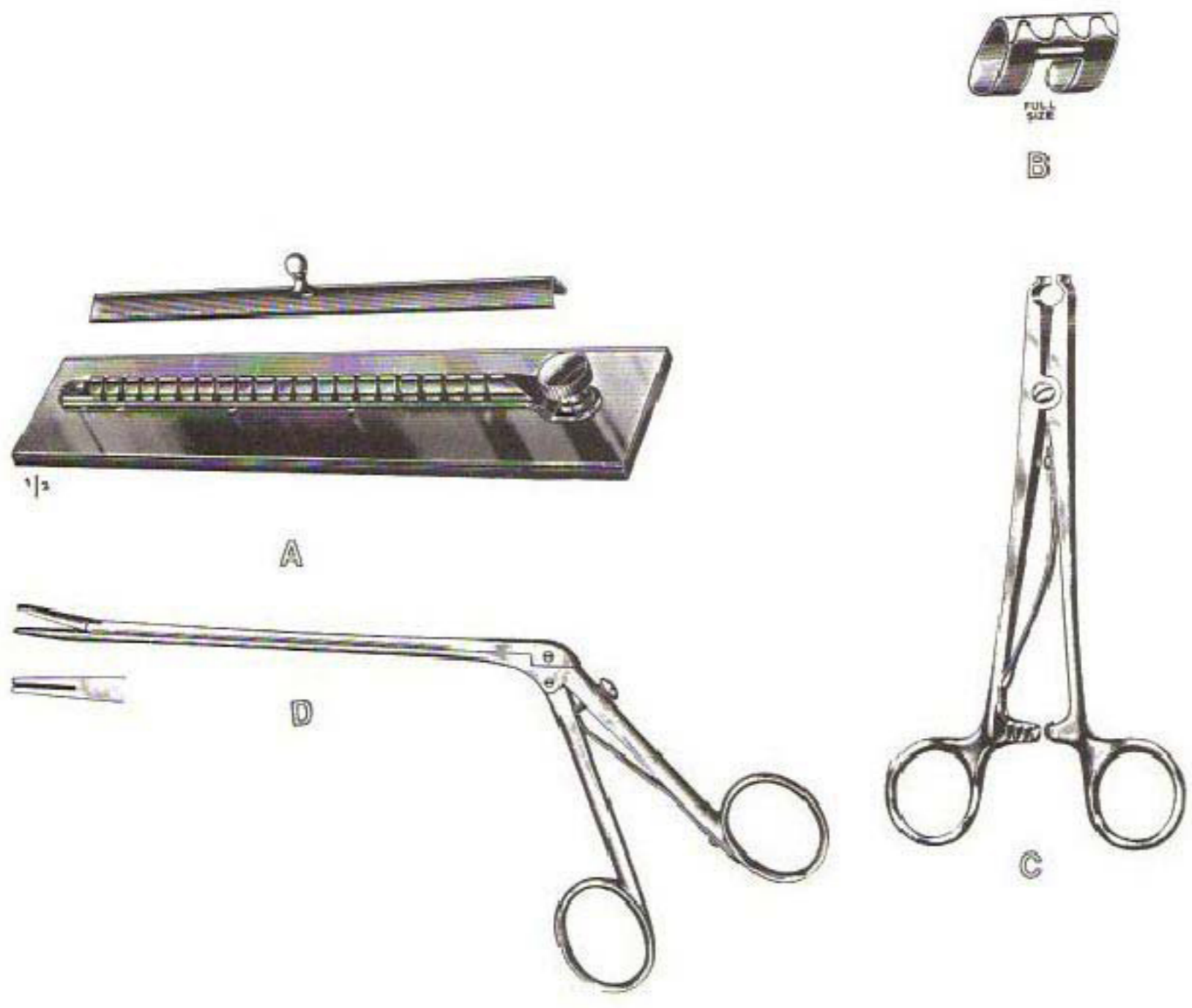

### NEUROSURGICAL INSTRUMENTS

- A 722-207 McKenzie Clip Rack Chrome
- B 722-306 Raney Scalp Clips, Nickel Plated, Vial of 12
- C 722-355 Raney Scalp Clip Forceps, 6 1/2"
- D 722-360 Scoville Clip Applying Forceps, 6" (15.2cm) Shaft



## NEUROSURGICAL INSTRUMENTS



- A** 722-400 Stille Pattern Drill Set, Complete with 4 Twist Drills, (2.5 to 4mm)  
4 Burs (4-16mm and 1 Trepine 10mm), Chrome Plated Drill,  
Stainless Points
- 722-405 Stille Pattern Drill 10" (25.4cm), Chrome Plated

### REPLACEMENT POINTS for STILLE PATTERN DRILLS

Twist Drills		Round Burs	
<b>B</b> 722-406	Fig. 1 = 2.5mm	722-416	Fig. 6 = 5mm
722-408	Fig. 2 = 3mm	722-418	Fig. 7 = 8mm
722-410	Fig. 3 = 3.5mm	722-420	Fig. 8 = 12mm
722-412	Fig. 4 = 4mm	722-422	Fig. 9 = 16mm
722-414	Fig. 5 = 10mm Trepine 10mm Dia.		

**C** 722-424 Raney-Crutchfield Skull Traction Tong 120mm  
Spread includes 2 Drill Points  
Raney-Crutchfield Drill Points





## NEUROSURGICAL INSTRUMENTS



- A** 720-201 Galt Cranial Trepine, 1/2" Diam.  
720-219 Galt Cranial Trepine, 5/8" Diam.  
720-227 Galt Cranial Trepine, 3/4" Diam.  
720-235 Galt Cranial Trepine, 1" Diam.
- B** 722-430 Universal Hand Drill  
Application: For Light-Duty Drilling Procedures  
Fully canulated shaft, can be locked by button on top  
With no strain on gearing, includes Jacobs Chuck
- C** 722-432 Jacobs Chuck Key, Stainless  
**D** 722-434 Jacobs Chuck only, Stainless  
**E** 722-436 Jacobs Chuck with Drill Handle, 4" Fully Canulated  
**F** 722-438 Steinmann-Jacobs Drill Handle w/Three-Jaw Chuck  
Locked by Rotable Sleeve



## NEUROSURGICAL INSTRUMENTS

- A** 722-425 Oldberg Pituitary Rongeur 7" (17.8 cm) Shank, Round Cup Jaws 6mm Dia.
- B** 722-426 Ferris Smith Pituitary Cup Jaw Rongeurs, 7" (17.8 cm) Shank Straight, 3x10 mm Jaws
- C** 722-427 Ferris Smith Pituitary Cup Jaw Rongeur, 7" (17.8 cm) Shank Curved up, 3x10 mm Jaws
- D** 722-428 Ferris Smith Pituitary Cup Jaw Rongeur, 7" (17.8 cm) Shank Curved Down, 3x10 mm Jaws



## ORTHOPEDIC INSTRUMENTS

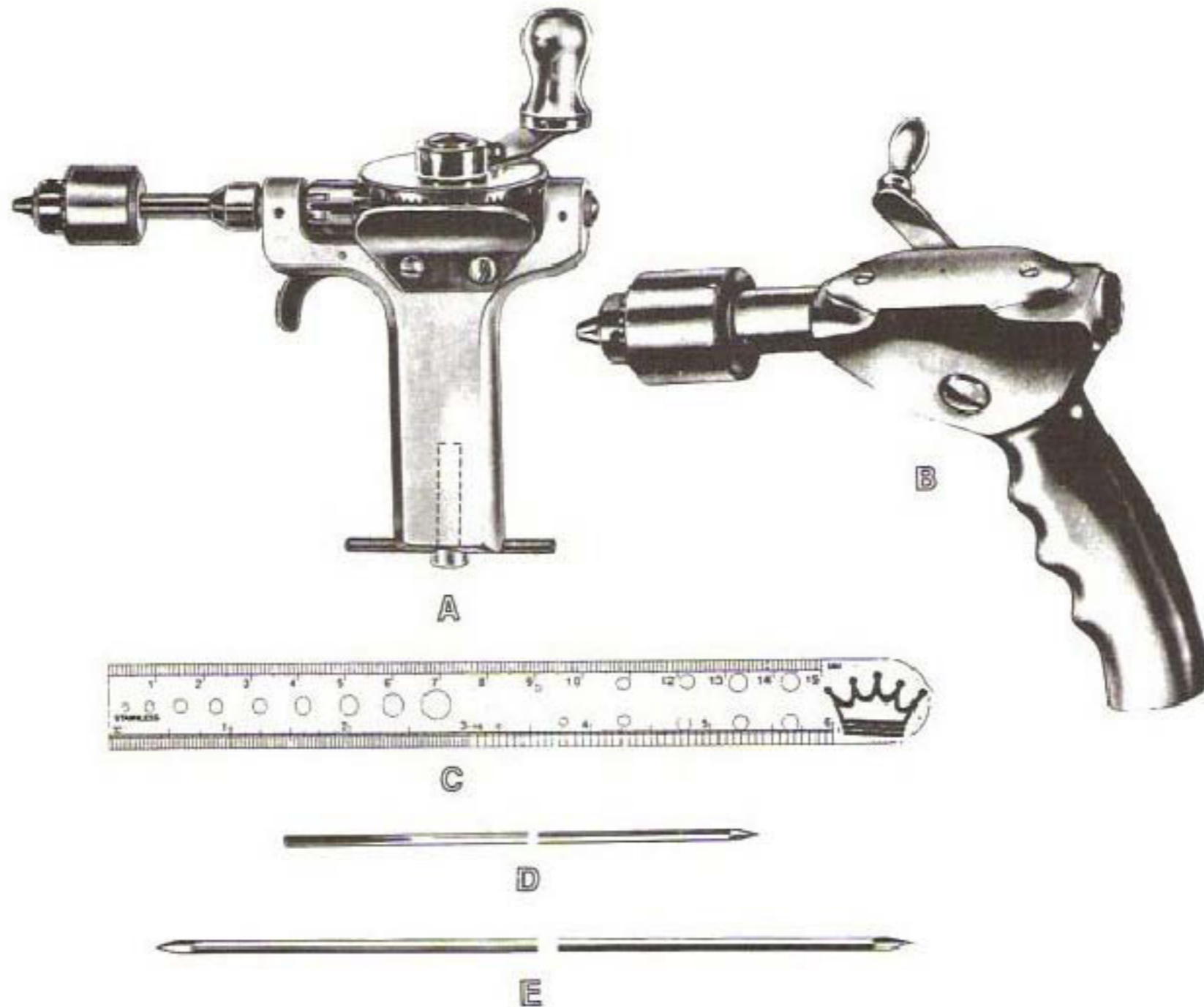

- A** 722-440 Bunnell Hand Drill, Lightweight, Chrome Plated with 5/32" (14mm) Capacity, Stainless Jacobs Chuck  
Chuck Key Stores in Handle
- B** 722-442 Ralk Bone Drill Offset Handle, w/Jacobs Chuck
- C** 722-444 Pin and Wire Gauge for Kirschner Wires, 6"
- D** 722-446 Kirschner Wires, 12", Trocar Point with Flat Chuck End, .035 Diameter  
722-448 Kirschner Wires, 12", Trocar Point with Flat Chuck End, .045 Diameter  
722-450 Kirschner Wires, 12", Trocar Point with Flat Chuck End, .0625  
Kirschner Wires, 12", Trocar Point
- E** 722-452 Kirschner Wires, 7 1/2", Trocar Point at Both Ends .035 Dia.  
722-454 Kirschner Wires, 7 1/2", Trocar Point at Both Ends, .045 Dia.  
722-456 Kirschner Wires, 7 1/2", Trocar Point at Both Ends, .0625 Dia.



## NEUROSURGICAL INSTRUMENTS

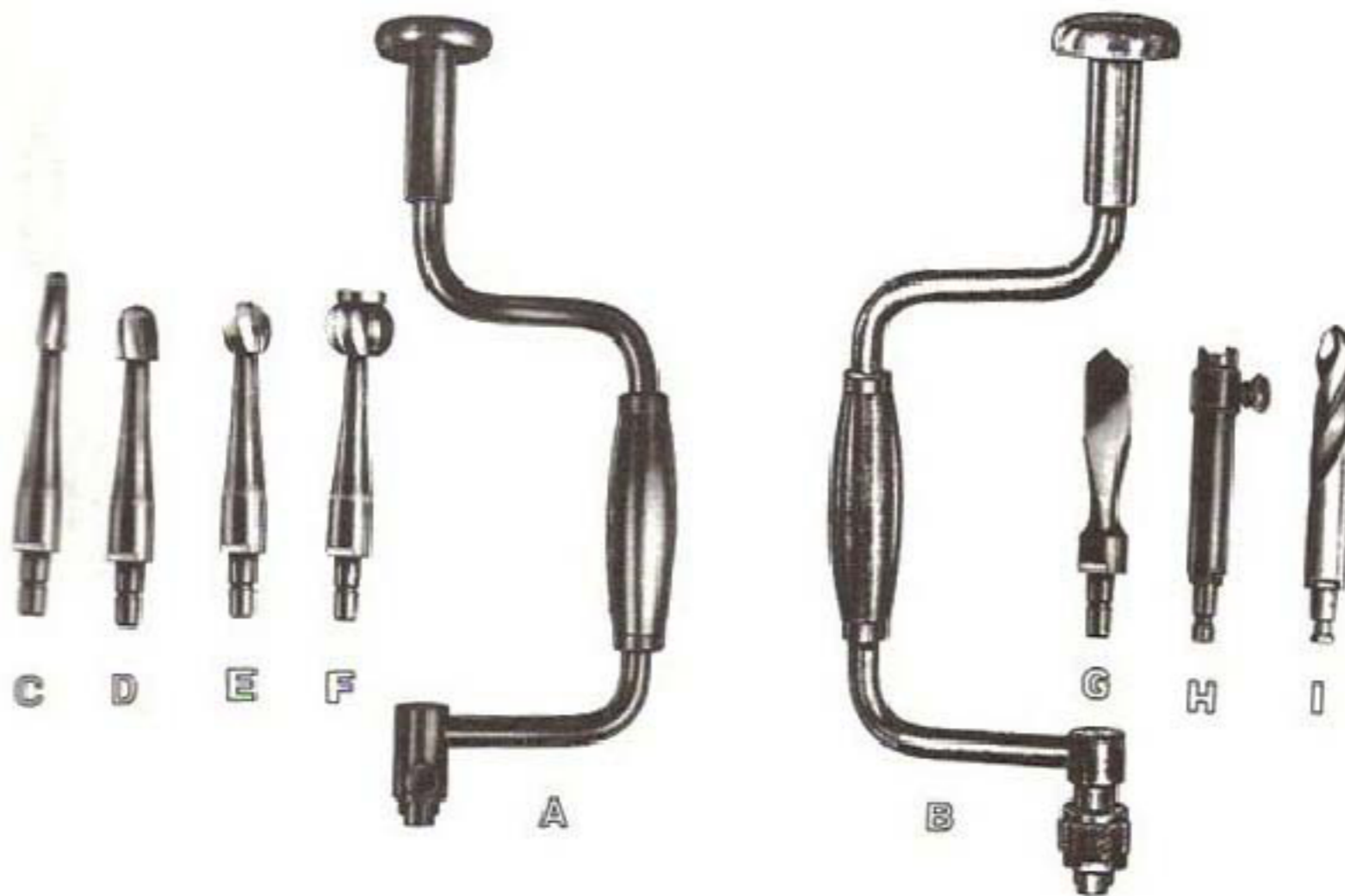

- A** 722-455 Hudson Brace 10 ½" (26.7cm), with Standard Thumb Screw Chuck
- B** 722-460 Hudson Brace 11" (27.9cm), with Improved Snap-Lock Chuck
  
- C** 722-462 Hudson Bur, 9mm Diameter
- D** 722-464 Hudson Bur, 14mm Diameter
- E** 722-466 Hudson Bur, 16mm Diameter
- F** 722-468 Hudson Bur, 22mm Diameter
  
- G** 722-470 Cushing Perforator, for Hudson Brace
- H** 722-472 Hudson Cerabellar Extension, 4" for Hudson Brace
- I** 722-474 McKenzie Perforator for Hudson Brace

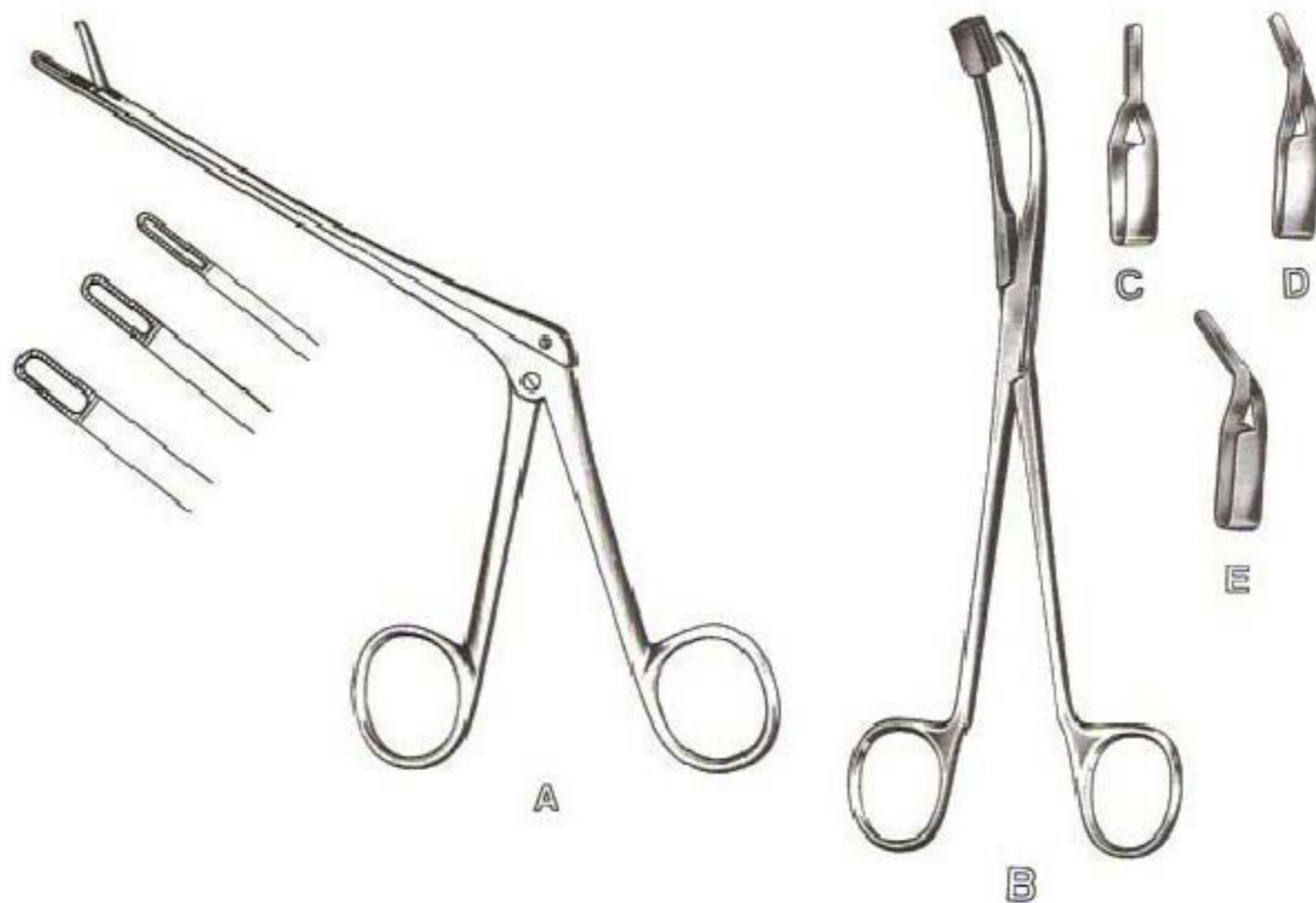

## NEUROSURGICAL INSTRUMENTS

<b>A</b>	722-476	Schlesinger Pituitary Rongeur, Serrated Cup Jaws, Straight 6" (15.2 cm) Shanks, 2x10 mm Bite
	722-478	Schlesinger Pituitary Rongeur, Serrated Cup Jaws, Straight 6" (15.2 cm) Shanks, 3x10 mm Bite
	722-480	Schlesinger Pituitary Rongeur, Serrated Cup Jaws, Straight 6" (15.2 cm) Shanks, 4x10 mm Bite
<b>B</b>	722-482	Schwartz Clip Applying Forceps 8" (20.3 cm)
<b>C</b>	722-484	Schwartz Vessel Clip 1" (2.5 cm), Straight Jaws 1.7x8 mm
<b>D</b>	722-486	Schwartz Vessel Clip 1" (2.5 cm), Slightly Angled Jaws 1.7x8 mm
<b>E</b>	722-488	Schwartz Vessel Clip 1" (2.5 cm), Strong Angled Jaws 1.7x8 mm



## NEUROSURGICAL INSTRUMENTS

- |          |         |  |
|----------|---------|--|
| <b>A</b> | 722-510 | Love Nerve Root Retractor 8 ½" (21.6 cm), Straight, 7mm Blade        |
|          | 722-515 | Love Nerve Root Retractor 8 ½" (21.6 cm), Angled 45°, 7mm Blade      |
|          | 722-520 | Love Nerve Root Retractor 8 ½" (21.6 cm), Angled 90°, 7mm Blade      |
| <b>B</b> | 722-525 | Scoville Nerve Root Retractor 9" (22.9 cm), Straight, 8mm Wide Blade |
| <b>C</b> | 722-530 | Scoville Nerve Root Retractor 9" (22.9 cm), Angular, 8mm Wide Blade  |



## NEUROSURGICAL INSTRUMENTS

<b>A</b>	722-535	Adson Periosteal Elevator 6 ½" (16.5cm), Chisel Edge, Straight, 8mm Wide
<b>B</b>	722-540	Adson Periosteal Elevator 6 ½" (16.5cm), Blunt, Curved, 6mm Wide
<b>C</b>	722-545	Adson Periosteal Elevator 6 ½" (16.5cm), Semi-Sharp, Curved, 7mm Wide
<b>D</b>	722-550	Adson Periosteal Elevator 6 ½" (16.5cm), Semi-Sharp, Straight, 6mm Wide
<b>E</b>	722-555	Cushing Periosteal Elevator 6" (15.2cm)
<b>F</b>	722-560	Children's Hospital Brain Spatula, 8 ½" Long x 1/2" Wide Malleable, Silver Plated
<b>G</b>	722-565	Scoville Brain Spatula, 8", 3/8" and 1/2"
	722-570	Scoville Brain Spatula, 8" 5/8" and 7/8"

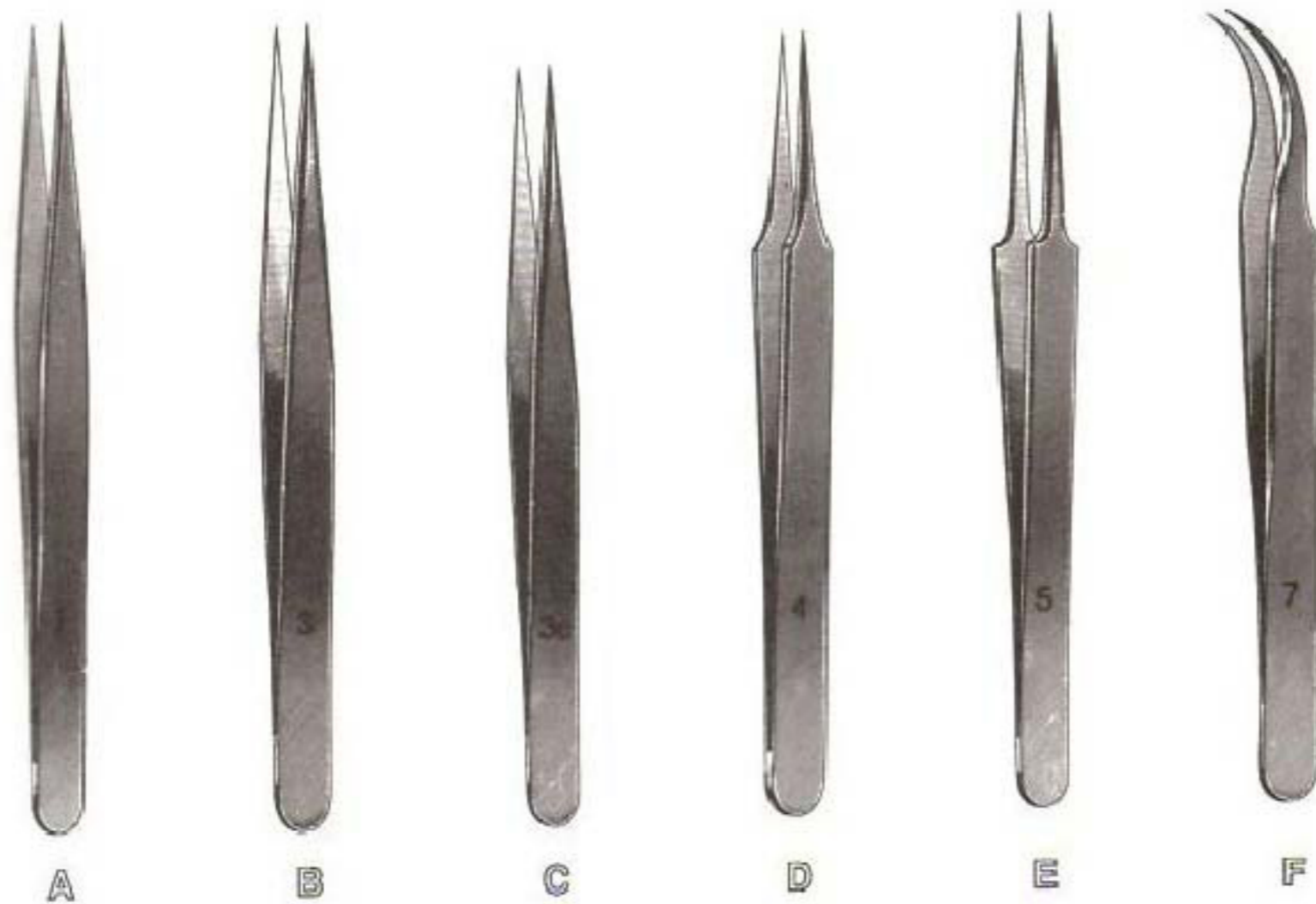

## MICRO SURGERY INSTRUMENTS

- A** 740-001 Swiss Jeweler Style Forceps, #1, 4-3/4" straight, fine points
- B** 740-003 Swiss Jeweler Style Forceps, #3, 4-3/4" straight, narrow fine points
- C** 740-033 Swiss Jeweler Style Forceps, #3C, 4-3/8" straight, narrow fine points
- D** 740-004 Swiss Jeweler Style Forceps, #4, 4-3/8" straight, fine points
- E** 740-005 Swiss Jeweler Style Forceps, #5, 4-3/8" straight, super fine points
- F** 740-007 Swiss Jeweler Style Forceps, #7, 4-1/2" curved, fine points



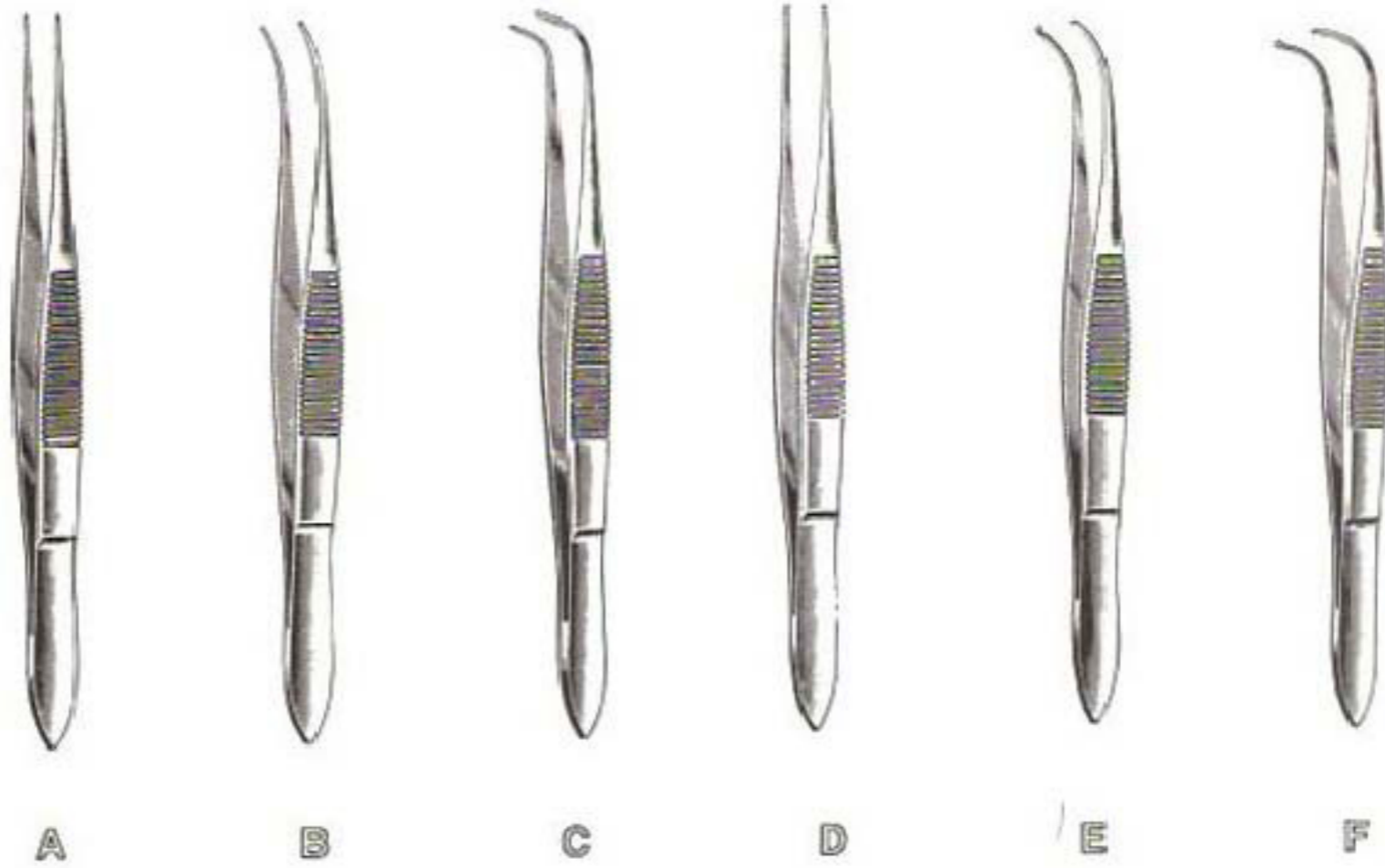

## EYE INSTRUMENTS

- |          |         |  |
|----------|---------|--|
| <b>A</b> | 420-802 | Eye Dressing Forceps, Straight, Extra Fine, Serrated, 4"       |
| <b>B</b> | 420-810 | Eye Dressing Forceps, Half Curved, Extra Fine, Serrated, 4"    |
| <b>C</b> | 420-828 | Eye Dressing Forceps, Fully Curved, Extra Fine, Serrated, 4"   |
| <b>D</b> | 421-800 | Iris Tissue Forceps, Straight, Extra Fine, 1 x 2 Teeth, 4"     |
| <b>E</b> | 421-818 | Iris Tissue Forceps, Half Curved, Extra Fine 1 x 2 Teeth, 4"   |
| <b>F</b> | 421-826 | Iris Tissue Forceps, Fully Curved, Extra Fine, 1 x 2 Teeth, 4" |

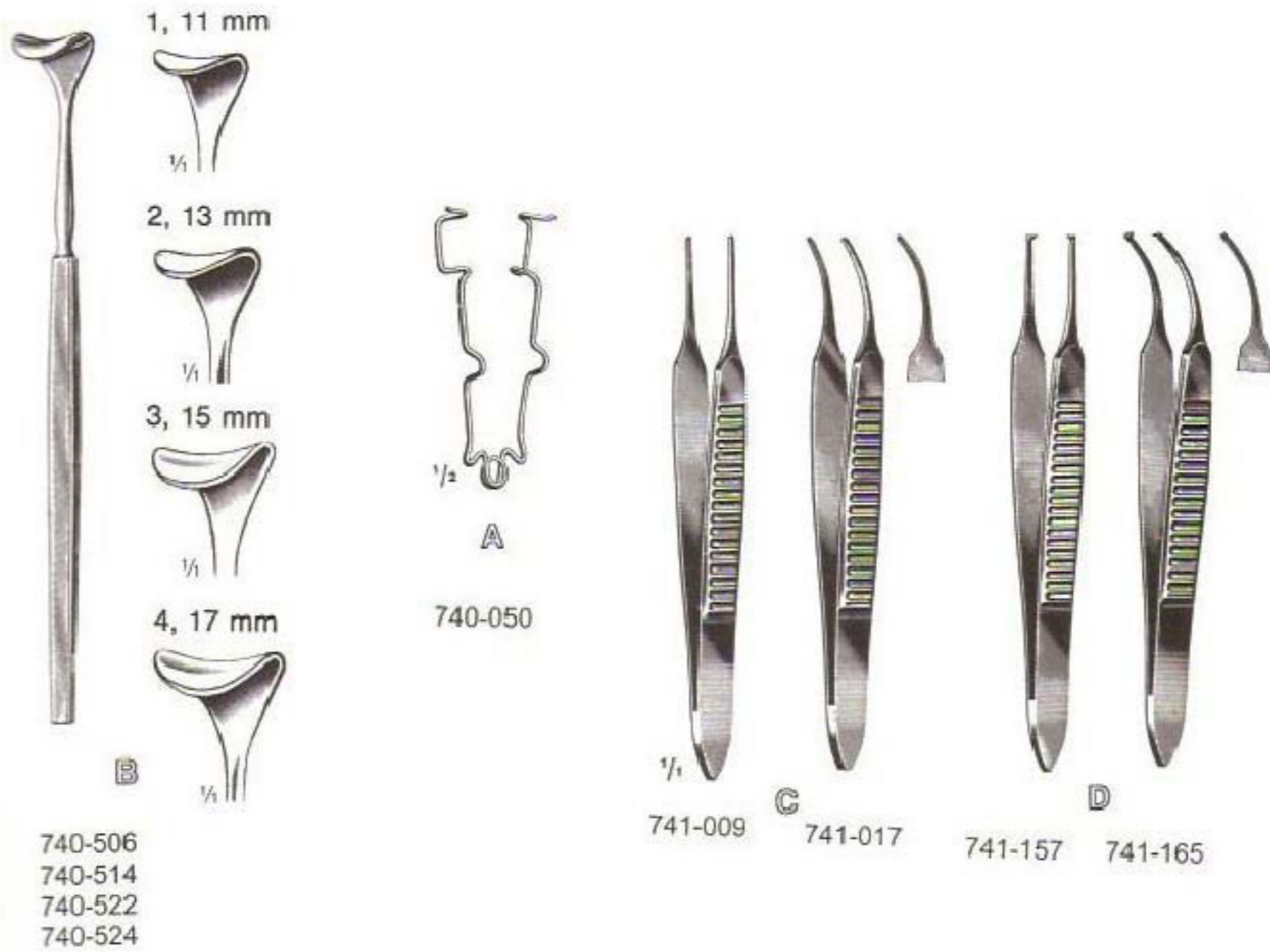

## EYE INSTRUMENTS

- |         |  |
|---------|--|
| 740-050 | Plain Wire Eye Speculum, 2-1/2" (6.4 cm), blades 15 mm wide    |
| 740-506 | DESMARRES Lid Retractor, 5-1/2" (14 cm), size 1, 11 mm         |
| 740-514 | DESMARRES Lid Retractor, 5-1/2" (14 cm), size 2, 13 mm         |
| 740-522 | DESMARRES Lid Retractor, 5-1/2" (14 cm), size 3, 15 mm         |
| 740-524 | DESMARRES Lid Retractor, 5-1/2" (14 cm), size 4, 17 mm         |
| 741-009 | GRAEFE Eye Dressing Forceps, 2-3/4" (7 cm), straight, serrated |
| 741-017 | GRAEFE Eye Dressing Forceps, 2-3/4" (7 cm), curved, serrated   |
| 741-157 | GRAEFE Iris Forceps, 2-3/4" (7 cm), straight, 1 X 2 teeth      |
| 741-165 | GRAEFE Iris Forceps, 2-3/4" (7 cm), curved, 1 X 2 teeth        |



## EYE INSTRUMENTS

- A** 421-830 Foerster Eye Dressing Forceps, 3-3/4", Octagonal Grip, Straight, Serrated Tips, 0.5mm Wide  
421-832 Foerster Eye Dressing Forceps, 3-3/4", Octagonal Grip, Straight, Smooth Tips, 0.5mm Wide
- B** 421-835 Foerster Eye Dressing Forceps, 3-3/4", Octagonal Grip, Curved, Serrated Tips, 0.5mm Wide  
421-838 Foerster Eye Dressing Forceps, 3-3/4", Octagonal Grip, Curved, Smooth Tips, 0.5mm Wide
- C** 421-840 Foerster Iris Tissue Forceps, 3-3/4", Octagonal Grip, Straight, 1 x 2 Teeth, 0.5mm Wide
- D** 421-845 Foerster Iris Tissue Forceps, 3-3/4", Octagonal Grip, Curved, 1 x 2 Teeth, 0.5mm Wide

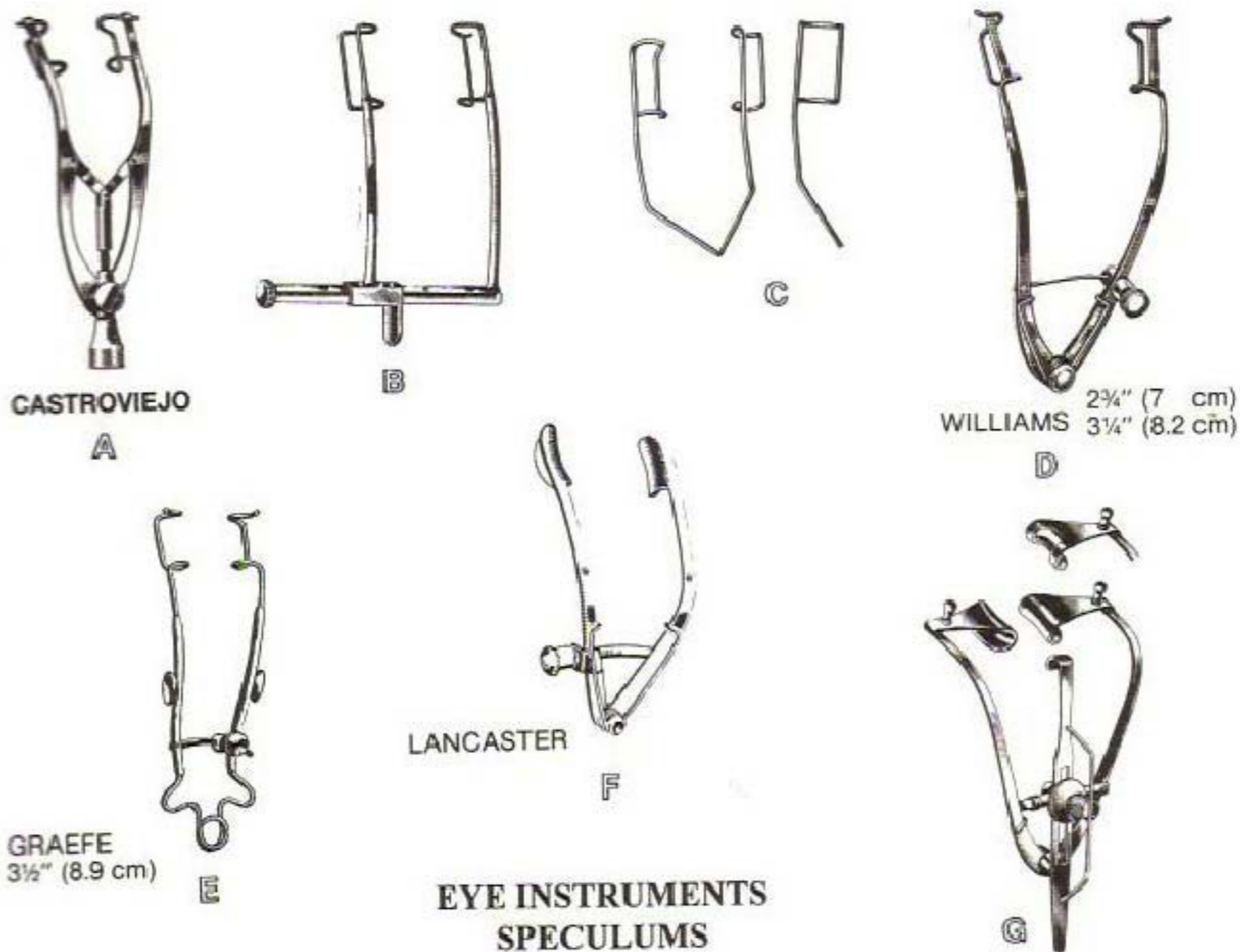

- A 741-220 Castroviejo Eye Speculum, 3.75" Small Blades 13x5mm O.D
- 741-222 Castroviejo Eye Speculum, 3.75" Medium Blades 15x5mm O.D.
- 741-224 Castroviejo Eye Speculum, 4" Large Blades 18x5mm O.D.
  
- B 741-250 Murdock Eye Speculum, 2.25" Blades 15mm Wide
  
- C 741-300 Barraquer Eye Speculum, 1.75" Small Blades 10mm Wide
- 741-310 Barraquer Eye Speculum, 1.75" Large Blades 15mm Wide
  
- D 741-320 Williams Eye Speculum 2 3/4", Small Blades 11x5mm
- 741-325 Williams Eye Speculum 3 3/4" Large Blades 15x5mm
  
- E 741-350 Von Graefe Eye Speculum, 3.5"
  
- F 741-355 Lancaster Eye Speculum, 3.25" Blades 15x5mm
  
- G 741-360 Guyton-Park Eye Speculum 3.5" Solid Blades 14mm Wide with Suture Posts
- 741-365 Guyton-Park Eye Speculum, 3.5" Fenestrated Blades 14mm Wide with Suture Posts

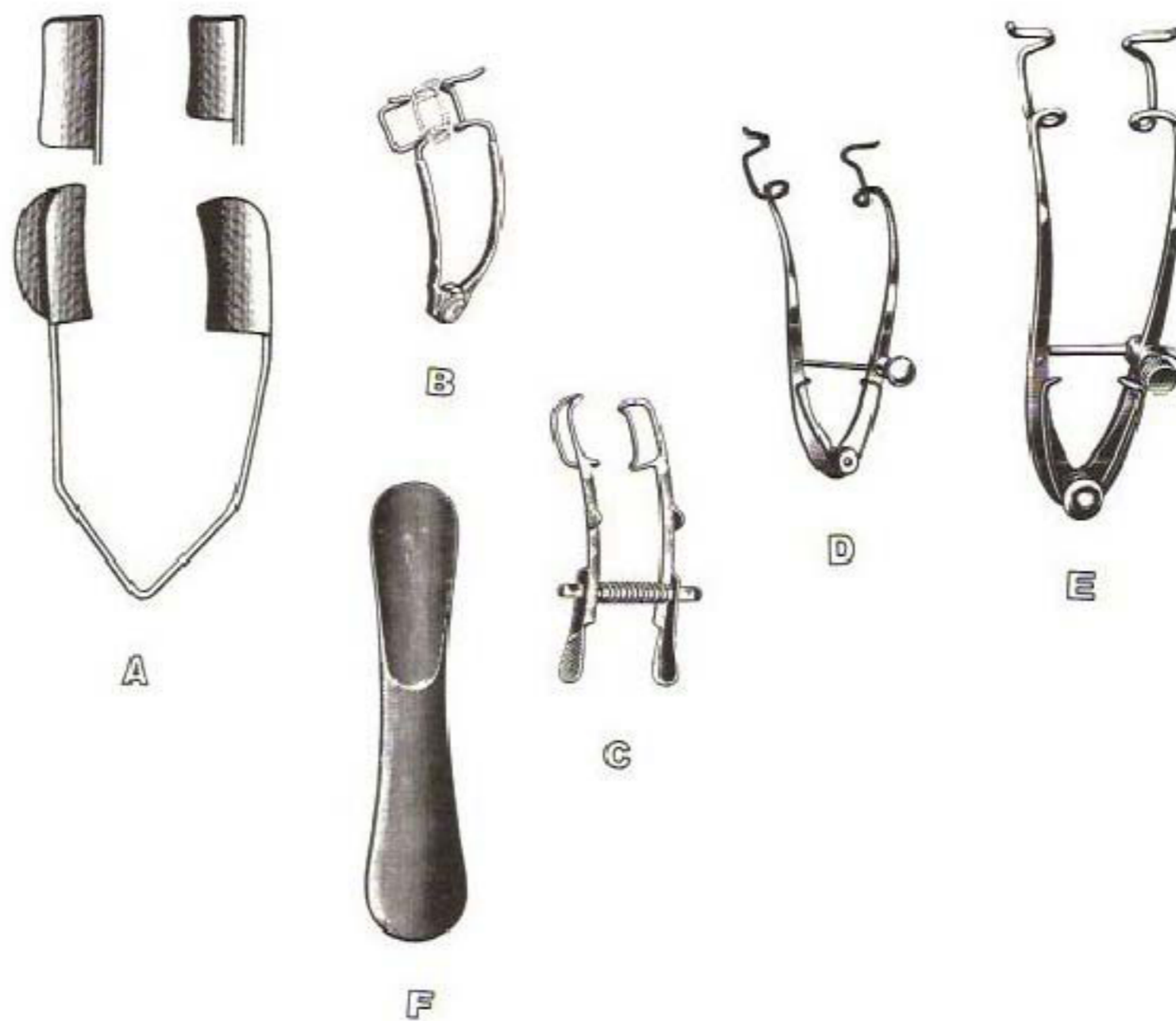

## EYE INSTRUMENTS SPECULUMS

- |          |                |  |
|----------|----------------|--|
| <b>A</b> | <b>741-370</b> | <b>Barraquer Eye Speculum, 1 ½" Long, 10mm, Solid Blade, Child</b> |
|          | <b>741-372</b> | <b>Barraquer Eye Speculum, 1 ½" Long, 15mm, Solid Blade, Adult</b> |
| <b>B</b> | <b>741-375</b> | <b>Smith Eye Speculum, 5cm</b>                                     |
| <b>C</b> | <b>741-380</b> | <b>Clark Eye Speculum, 8cm</b>                                     |
| <b>D</b> | <b>741-385</b> | <b>Knapp Eye Speculum, Non-Magnetic</b>                            |
| <b>E</b> | <b>741-390</b> | <b>Mellinger Eye Speculum, 5cm</b>                                 |
|          | <b>741-395</b> | <b>Mellinger Eye Speculum, 7cm</b>                                 |
| <b>F</b> | <b>741-400</b> | <b>Jaeger Lid Plate, 11cm</b>                                      |

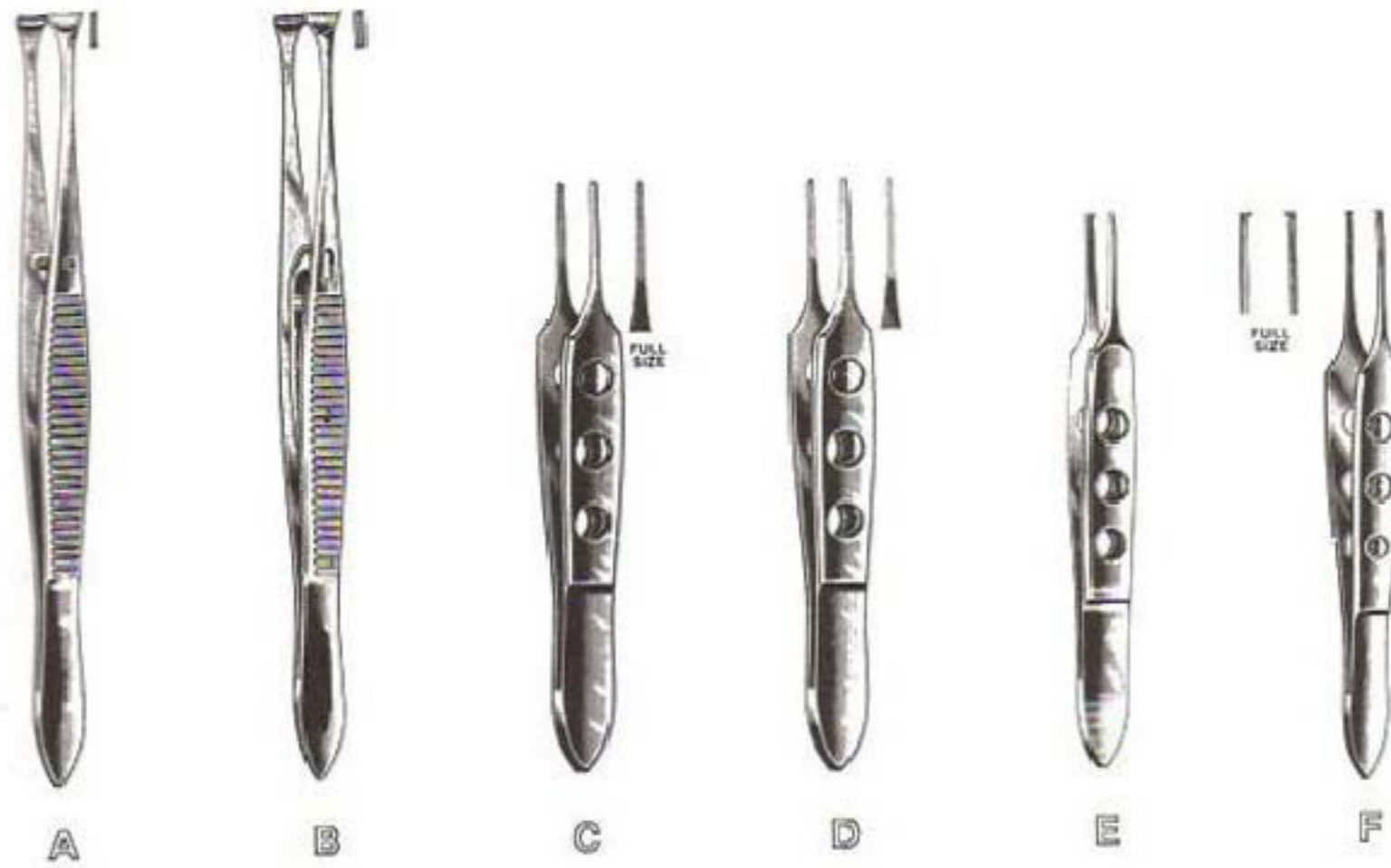

## EYE INSTRUMENTS

- A** 741-504 Von Graefe Fixation Forceps, 4-1/4"
- B** 741-512 Von Graefe Fixation Forceps, with Catch, 4-1/4"
  
- C** 741-524 Bishop-Harmon Dressing Forceps, Str., Del., 0.5mm Wide, 3-3/8"
- D** 741-528 Bishop-Harmon Dressing Forceps, Straight, Serr., 0.8mm Wide, 3-3/8"
  
- E** 741-532 Bishop-Harmon Tissue Forceps, Str., 1 x 2 Teeth, 0.5mm Wide, 3-3/8"
- F** 741-536 Bishop-Harmon Tissue Forceps, Str., 1 x 2 Teeth, 0.8mm Wide, 3-3/8"



741-603

LESTER Fixation  
delicate, 1 X 2 teeth

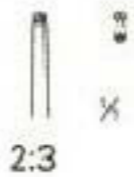

741-605

LESTER Fixation  
delicate, 2x3 teeth



741-801



742-007



742-502



742-551



742-759

### EYE INSTRUMENTS

- 741-603 LESTER Fixation Forceps, 3-3/4" (9.5 cm), delicate, 1 X 2 teeth, 0.6 mm wide
- 741-605 LESTER Fixation Forceps, 3-3/4" (9.5 cm), delicate, 2x3 teeth, 1 mm wide
- 741-801 Eye Knife test drum
- 742-007 DESMARRES Chalazion Forceps, 3-1/2" (8.9 cm), large size, inside ring 17 X 28 mm
- 742-502 BARRAQUER Blade Breaker and Holder, 4-1/2" (11.4 cm), with ratchet lock
- 742-551 CASTROVIEJO Blade Breaker and Holder, 5-1/4" (13.3 cm), with push-pull lock
- 742-759 WELLS Enucleation Scoop, 6" (15.2 cm), cup 21 mm

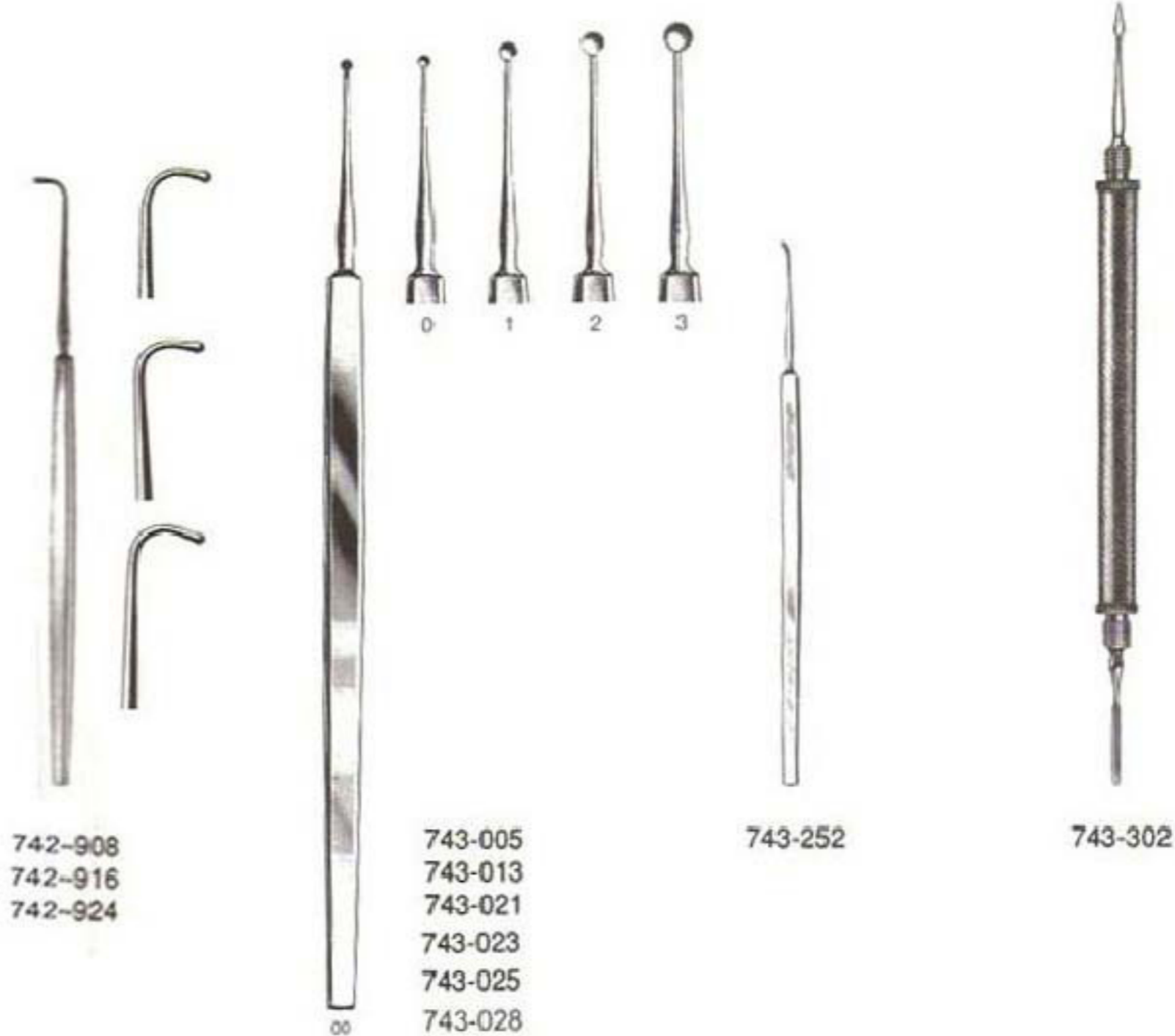

## EYE INSTRUMENTS

- |         |  |
|---------|--|
| 742-908 | Von Graefe Strabismus Hook, Small, 5 1/2"        |
| 742-916 | Von Graefe Strabismus Hook, Medium, 5 1/2"       |
| 742-924 | Von Graefe Strabismus Hook, Large, 5 1/2"        |
| 743-005 | Meyhoeffler Chalazion Curette, 5", Size 00, 1mm  |
| 743-013 | Meyhoeffler Chalazion Curette, 5", Size 0, 1.5mm |
| 743-021 | Meyhoeffler Chalazion Curette, 5", Size 1, 1.7mm |
| 743-023 | Meyhoeffler Chalazion Curette, 5", Size 2, 2mm   |
| 743-025 | Meyhoeffler Chalazion Curette, 5", Size 3, 2.5mm |
| 743-028 | Meyhoeffler Chalazion Curette, 5", Size 4, 3.5mm |
| 743-252 | Risley (LaForce) Foreign Body Spud, Angular, 6"  |
| 743-302 | Dix Needle and Spud, Reversible Handle, 6"       |



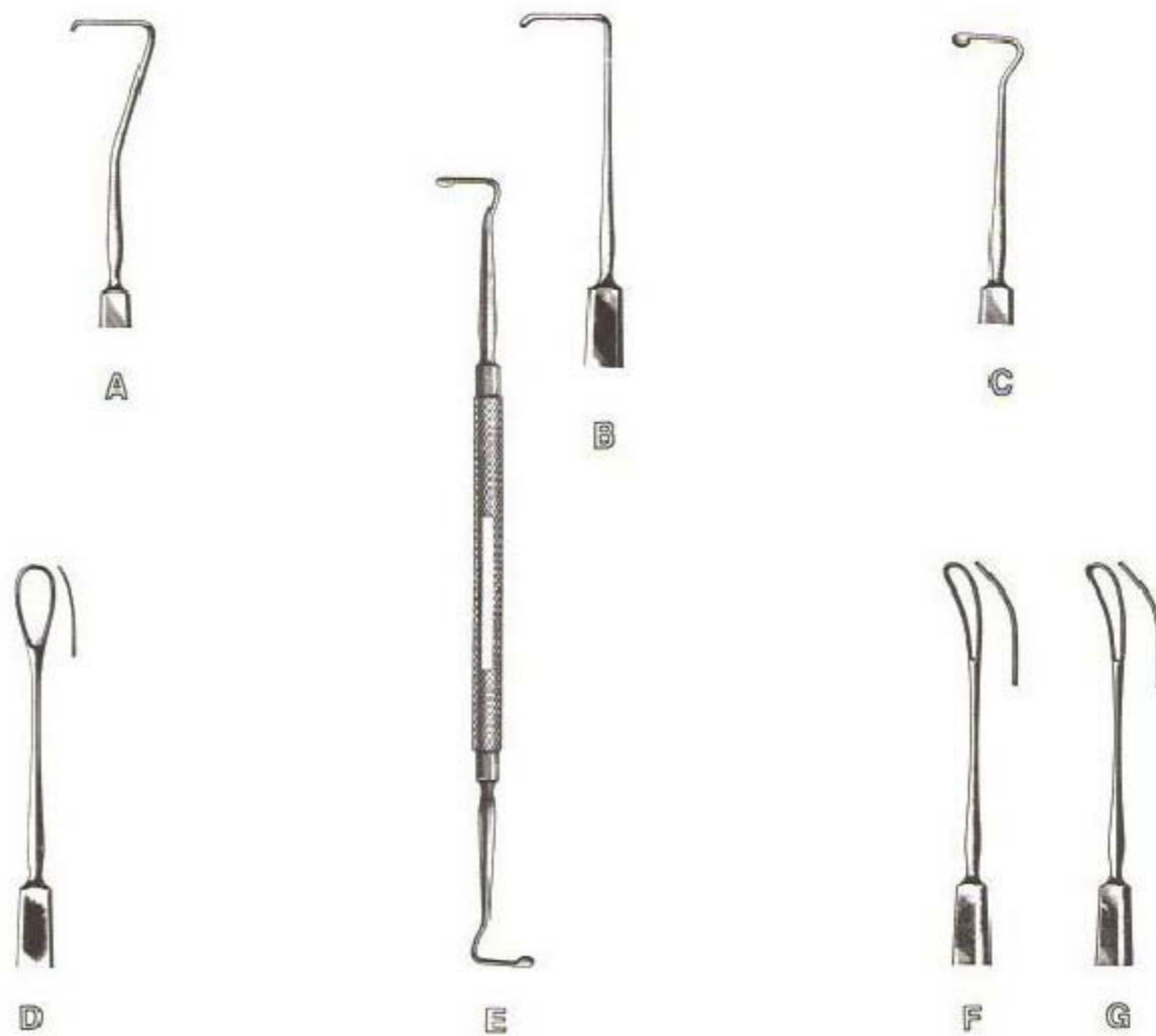

## EYE INSTRUMENTS

- |          |         |  |
|----------|---------|--|
| <b>A</b> | 742-928 | Green Strabismus Hook, 5" 9mm Deep                                   |
| <b>B</b> | 742-930 | O'Connor Tenotomy Hook, 5", Fine serrations inside                   |
| <b>C</b> | 742-934 | Jameson Strabismus Hook, 5", 10mm Deep                               |
| <b>D</b> | 742-936 | New Orleans Lens Loop, 5 1/4", Smooth Loop, 4.5 x 10mm Very Delicate |
| <b>E</b> | 742-938 | Kirby Muscle Hook and Expressor 6", Double End                       |
| <b>F</b> | 742-940 | Wilder Lens Loop, 5 1/4", Serrated Loop, 4x15mm                      |
| <b>G</b> | 742-942 | Wilder Lens Loop, 5 1/4", Smooth Loop, 4x15mm                        |

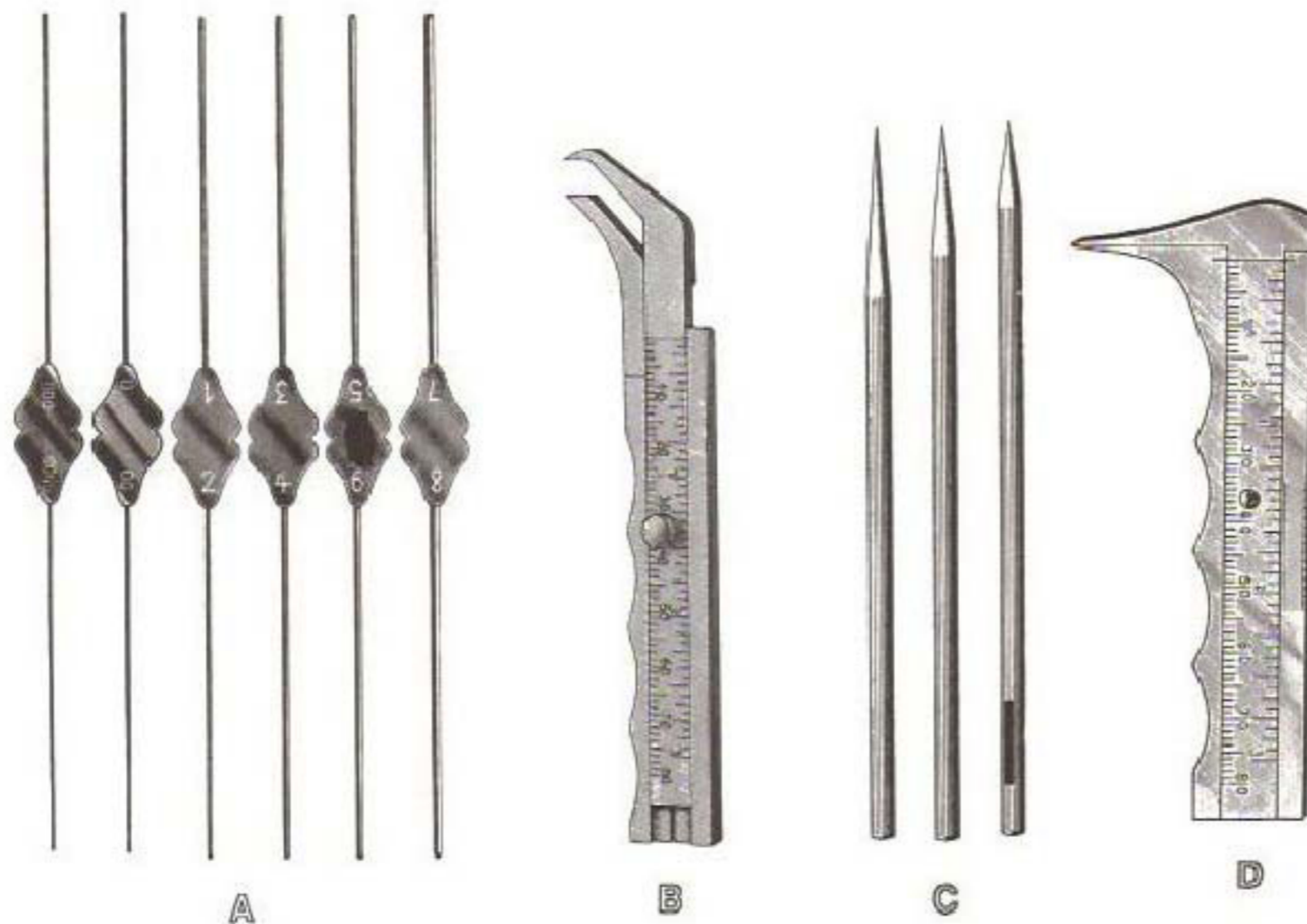

## EYE INSTRUMENTS

- A** 743-450 Bowman Probe, 000-0000, Double Ended, Sterling Silver, 5"  
743-468 Bowman Probe, 00-0, Double Ended, Sterling Silver, 5"  
743-476 Bowman Probe, 1-2, Double Ended, Sterling Silver, 5"  
743-484 Bowman Probe, 3-4, Double Ended, Sterling Silver, 5"  
743-492 Bowman Probe, 5-6, Double Ended, Sterling Silver, 5"  
743-500 Bowman Probe, 7-8, Double Ended, Sterling Silver, 5"
- B** 743-505 Thorpe Caliper 4 ½" (11.4cm), Graduated in inches and mm, Permits measurements in deep areas
- C** 743-807 Wilder Lacrimal Dilator, 4", Fine Taper  
743-815 Wilder Lacrimal Dilator, 4", Medium Taper  
743-816 Wilder Lacrimal Dilator, 4", Heavy Taper
- D** 743-820 Jameson Caliper 3 ¾" (9.5cm), Graduated in inches and mm, with thin tips, Chrome

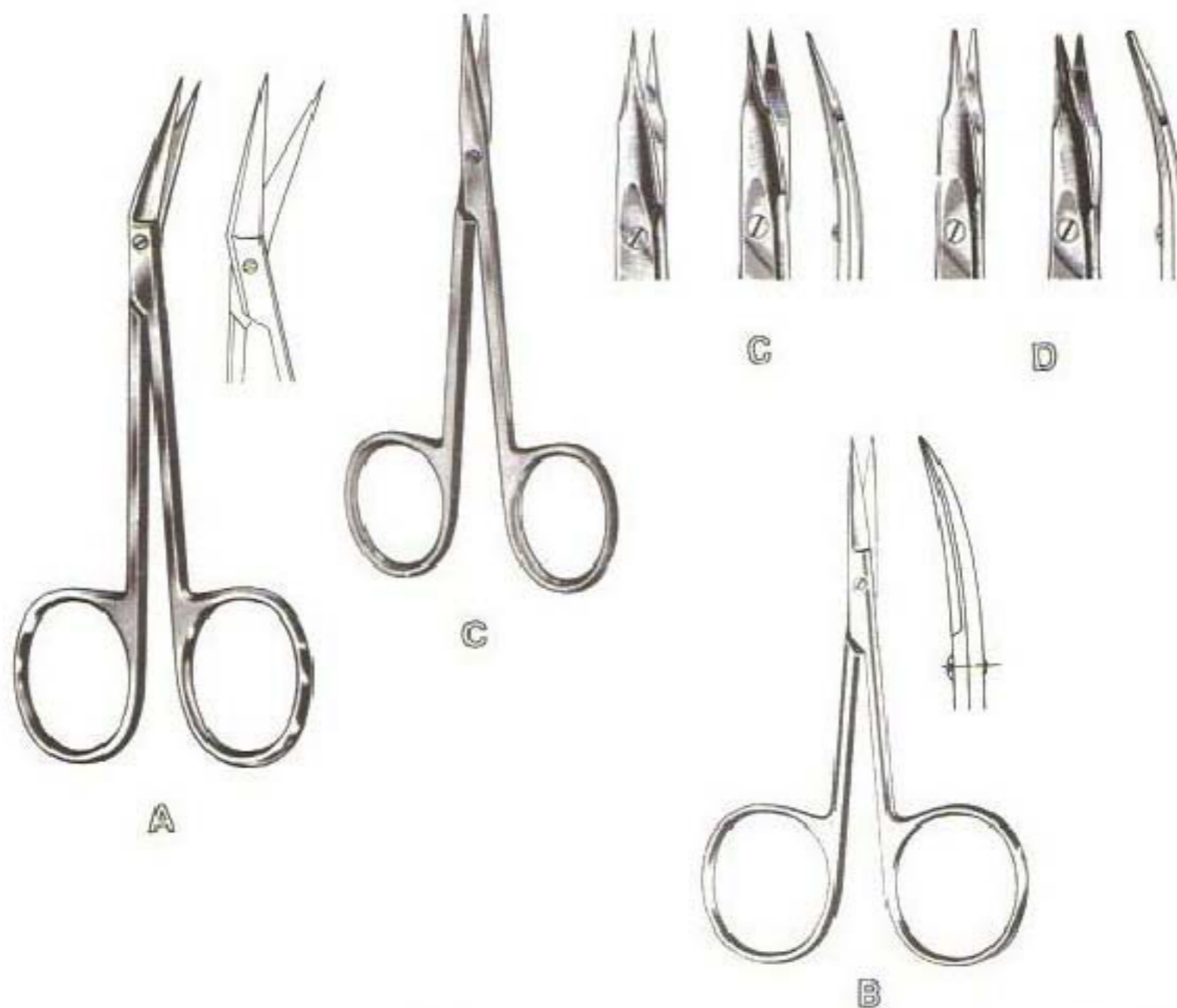

### EYE INSTRUMENTS

- A** 103-634 Iris Scissors, 4-1/2" (11.4 cm), angled on side
- B** 744-056 Eye Scissors, Large Rings, Sharp Tips, Straight, 4", Blades (104 mm)
- 744-058 Eye Scissors, Large Rings, Sharp Tips, Curved, 4", Blades (104 mm)
- C** 744-250 STEVENS Tenotomy Scissors, 4-1/2" (11.4 cm), straight, sharp points
- 744-255 STEVENS Tenotomy Scissors, 4-1/2" (11.4 cm), straight, blunt points
- D** 744-268 STEVENS Tenotomy Scissors, 4-1/2" (11.4 cm), curved, sharp points
- 744-270 STEVENS Tenotomy Scissors, 4-1/2" (11.4 cm), curved, blunt point
- E** 744-280 AECLI Corneal Scissors, 4" (10.2 cm), straight
- 744-282 AECLI Corneal Scissors, 4" (10.2 cm), angled on flat, right
- 744-284 AECLI Corneal Scissors, 4" (10.2 cm), angled on flat, left

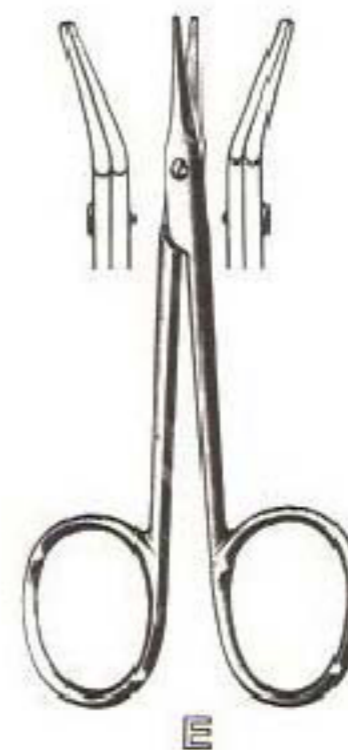

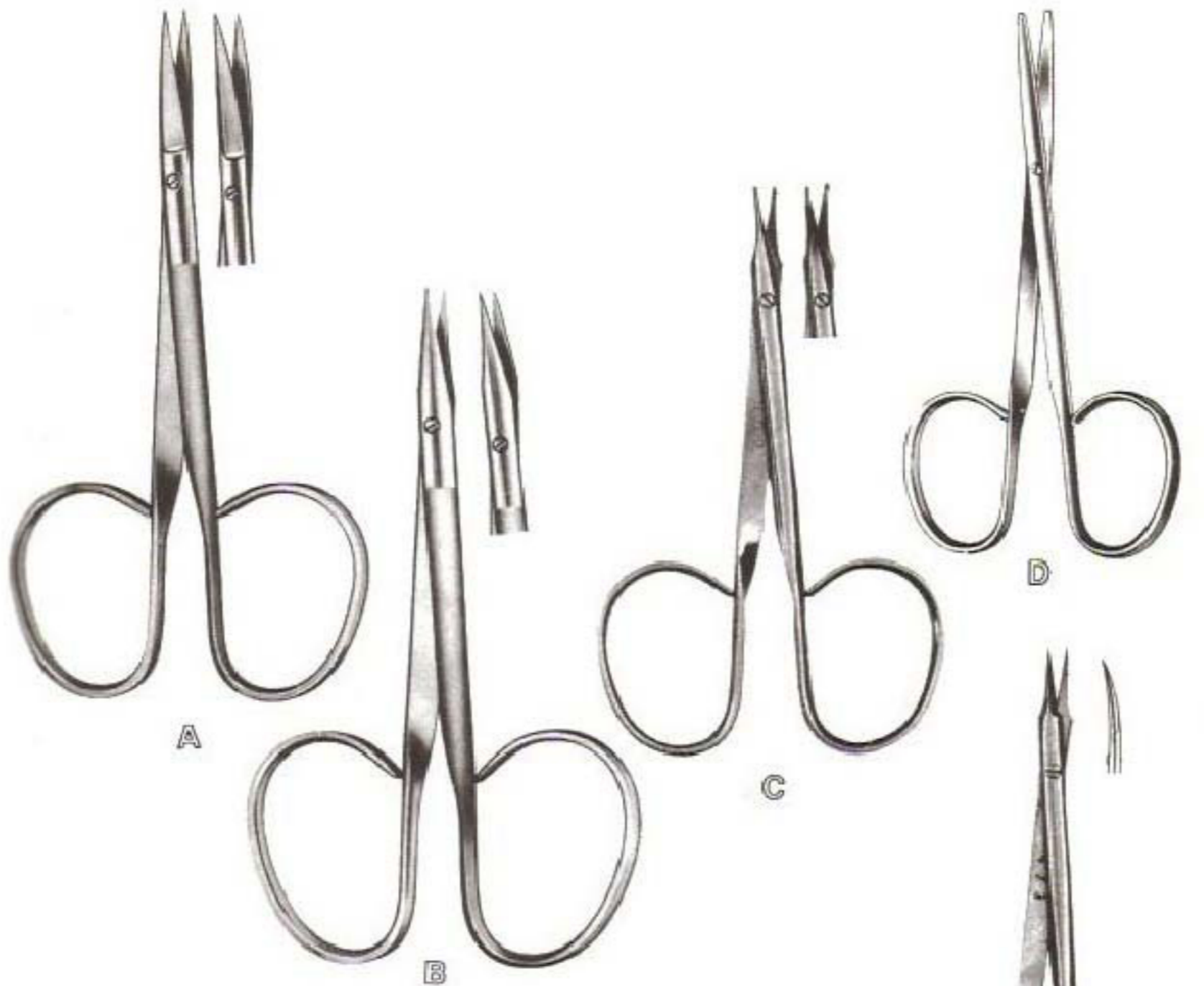

### RIBBON TYPE SCISSORS

- A** 744-060 Eye Scissors, Ribbon Type, Pointed Tips, Straight, 4.1" Blade (22 mm)
- 744-062 Eye Scissors, Ribbon Type, Pointed Tips, Curved, 4.1", Blade (22 mm)
- B** 744-064 STEVENS Tenotomy Scissors, Ribbon Type, Sharp Tips, Straight, 3.7", Blade (12mm)
- 744-066 STEVENS Tenotomy Scissors, Ribbon Type, Sharp Tips, Curved, 3.7", Blades (12 mm)
- C** 744-068 STEVENS Tenotomy Scissors, Ribbon Type, Blunt Tips, Straight, 3.7", Blades (12 mm)
- 744-070 STEVENS Tenotomy Scissors, Ribbon Type, Blunt Tips, Curved, 3.7", Blades (12 mm)
- D** 744-072 Strabismus Scissors, Ribbon Type, Straight, 4.2", Blades (25 mm)
- 744-074 Strabismus Scissors, Ribbon Type, Curved, 4.2", Blades (25 mm)
- E** 744-076 Stitch Scissors, Ribbon Type, Extra Fine Blades, Light Curve, 3.7", Blades (20 mm)
- F** 744-078 Utility Scissors, Ribbon Type, Blunt Tips, Straight, 4.1", Blades (20 mm)
- 744-080 Utility Scissors, Ribbon Type, Blunt Tips, Curved, 4.1", Blades (20 mm)

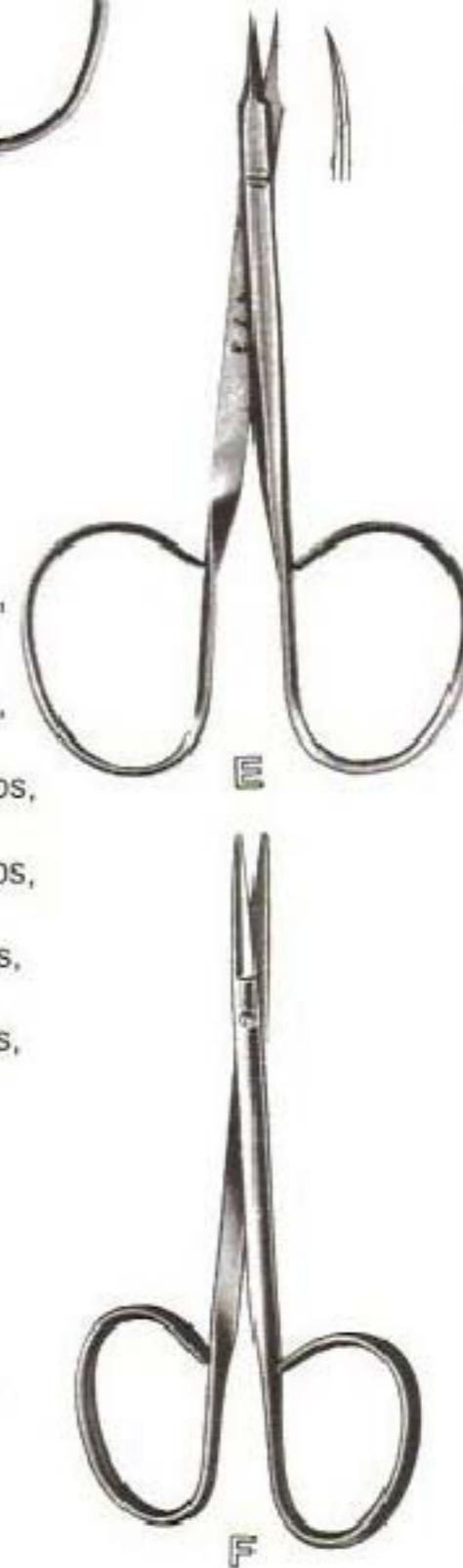

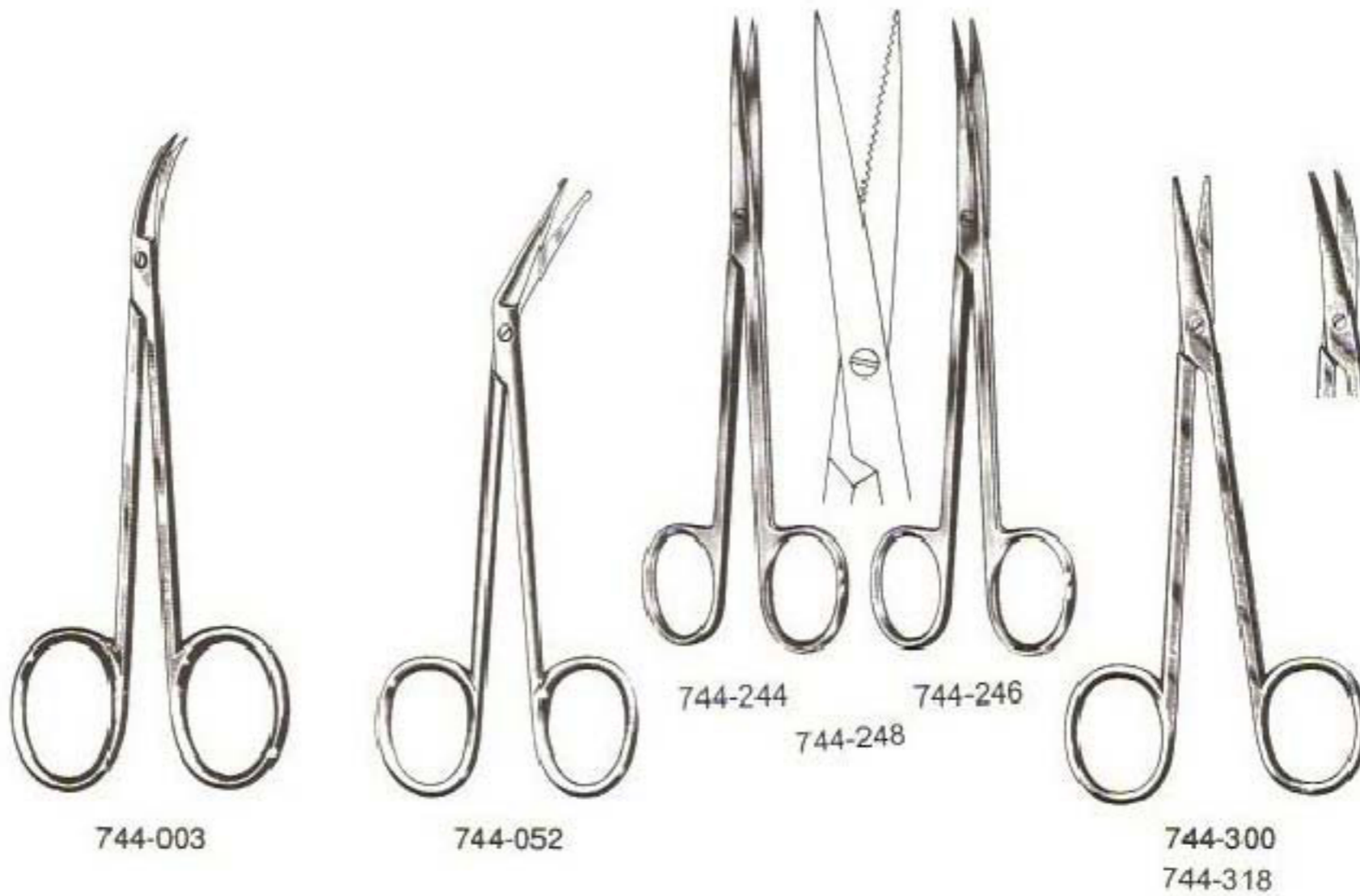

## EYE INSTRUMENTS



744-508

- 744-003 Iris Scissors, Curved Sideways, 4-1/2" (11 cm)
- 744-052 Iris Scissors, Angular with probe point, 4-1/2" (11 cm)
- 744-244 BROPHY (Sullivan) Scissors, Straight, 5-1/2" (14.5 cm)  
Sharp Points
- 744-246 BROPHY (Sullivan) Scissors, Curved, 5-1/2" (14.5 cm)  
Sharp Points
- 744-248 BROPHY (Sullivan) Scissors, Curved, 5-1/2" (14.5 cm)  
One Serrated Blade.
- 744-300 Strabismus Scissors, Straight, 4-1/2" (11 cm)
- 744-318 Strabismus Scissors, Curved, 4-1/2" (11 cm)
- 744-320 WESTCOTT Utility Scissors, Curved, Blunt Tips, 4-1/2" (11 cm)
- 744-508 BOWMAN Scissors, Curved, Probe Points, 4-1/2" (11 cm)



744-607

744-609



**Castroviejo**  
744-600



**Castroviejo**  
744-602



**Vannas**  
744-994

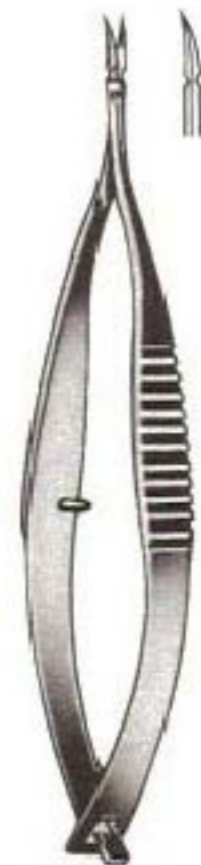

**Vannas**  
744-995



**Vannas**  
744-996

744-566  
744-567

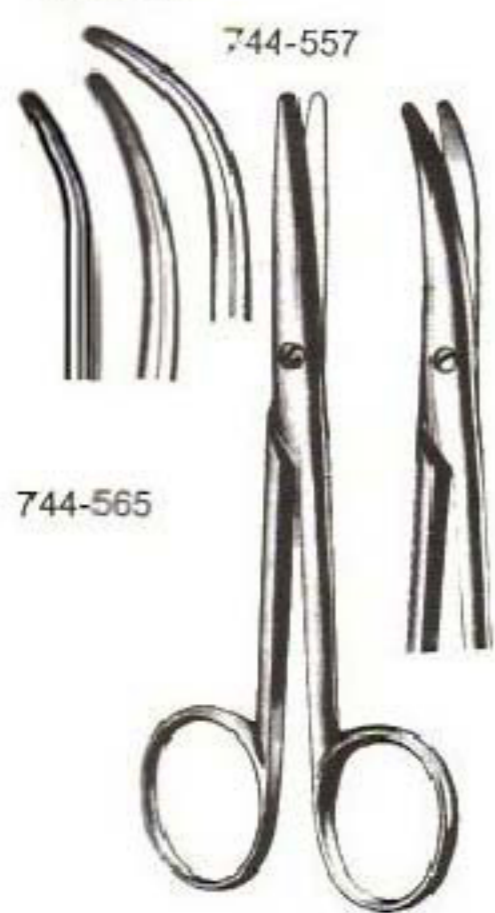

744-557

744-565

A

### EYE INSTRUMENTS

- 744-557 Enucleation Scissors, Straight, 5" (12.7cm)
- 744-565 Enucleation Scissors, light curve, 5" (12.7cm)
- 744-566 Enucleation Scissors, Medium curve, 5" (12.7cm)
- 744-567 Enucleation Scissors, full curve, 5" (12.7cm)
- 744-600 CASTROVIEJO Scissors, Curved, Sharp Points, 4" (10cm)
- 744-602 CASTROVIEJO Scissors, Curved, Blunt Points, 4" (10cm)
- 744-607 CASTROVIEJO Corneal Scissors, 3-3/4" (9.5 cm), angled blades 11 mm, blunt points
- 744-609 CASTROVIEJO Keratoplasty Scissors, 3-3/4" (9.5 cm), angled blades 11 mm, sharp points
- 744-994 VANNAS Micro Scissors, 3-1/4" (8.3 cm), straight
- 744-995 VANNAS Micro Scissors, 3-1/4" (8.3 cm), Curved
- 744-996 VANNAS Micro Scissors, 3-1/4" (8.3 cm), Angled on Flat



## OPERATING SCISSORS

- |         |   |
|---------|---|
| 744-706 | NOYES Iris Scissors, 4-1/2" (11.4 cm), straight, sharp/sharp points                 |
| 744-708 | NOYES Iris Scissors, 4-1/2" (11.4 cm), straight, sharp/blunt points                 |
| 744-710 | NOYES Iris Scissors, 4-1/2", straight (11.4 cm), blunt/blunt points                 |
| 744-712 | NOYES Iris Scissors, 4-1/2" (11.4 cm), curved, sharp/sharp points                   |
| 103-428 | BARRAQUER Iris Scissors, 2-1/4" (5.7 cm), angled 7 mm blades, sharp points          |
| 103-430 | BARRAQUER Iris Scissors, 2-1/4" (5.7 cm), angled 7 mm blades, blunt points          |
| 744-990 | MCPHERSON-VANNAS Micro Iris Scissors, 3-1/4" (8.3 cm), straight, sharp points       |
| 744-991 | MCPHERSON-VANNAS Micro Iris Scissors, 3-1/4" (8.3 cm), Curved, sharp points         |
| 744-992 | MCPHERSON-VANNAS Micro Iris Scissors, 3-1/4" (8.3 cm), Angled on Flat, sharp points |



### EYE INSTRUMENTS

- 745-000 VANNAS Capsulotomy Scissors, 3-1/4" (8.3 cm), straight, extra delicate sharp points
- 745-018 VANNAS Capsulotomy Scissors, 3-1/4" (8.3 cm), curved, extra delicate sharp points
- 745-020 VANNAS Capsulotomy Scissors, 3-1/4" (8.3 cm), angled to side, extra delicate sharp points
- 745-026 VANNAS Capsulotomy Scissors, 3-1/4" (8.3 cm), angled on flat, extra delicate sharp points

- 745-028 Micro Scissors, 3-1/4" (8.3 cm), straight super fine blades
- 745-030 Micro Scissors, 3-1/4" (8.3 cm), curved super fine blades

- 745-042 MCGUIRE Corneal Scissors, 4-1/8" (10.5 cm), right
- 745-044 MCGUIRE Corneal Scissors, 4-1/8" (10.5 cm), left

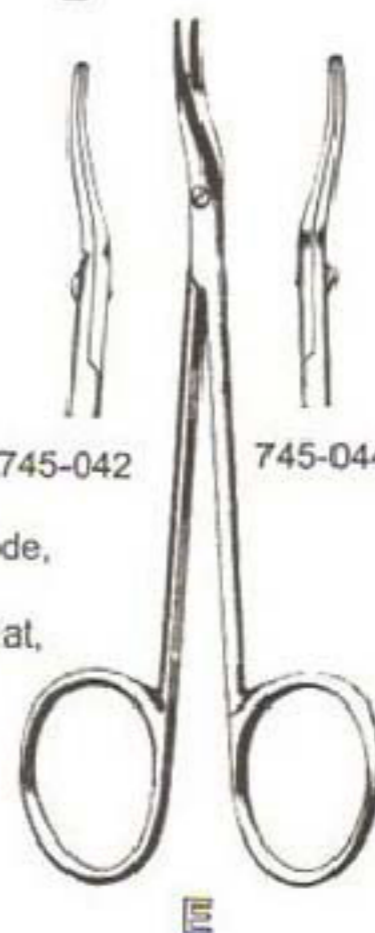





## OPERATING SCISSORS

- A** 745-032 Noyes Iridectomy Scissors 5 ½" (14 cm), Straight 7mm Blades
- B** 745-035 Castroviejo Corneal Section Scissors 4 ½" (11.4 cm), Right Inner Blade 1 mm Longer, Blunt Tips
- 745-040 Castroviejo Corneal Section Scissors 4 ½" (11.4 cm), Left Inner Blade 1 mm Longer, Blunt Tips
- C** 745-045 McClure Iris Scissors 3 ¾" (9.5 cm), Angled Over Edge, 4mm Blades with Very Delicate Sharp Points
- 745-050 McClure Iris Scissors 3 ¾" (9.5 cm) Angled on Flat, 4mm Blades with Very Delicate Sharp Points
- 745-055 McClure Iris Scissors 4" (10.2 cm), Angled on Flat, Regular 10mm Blades with Sharp Points

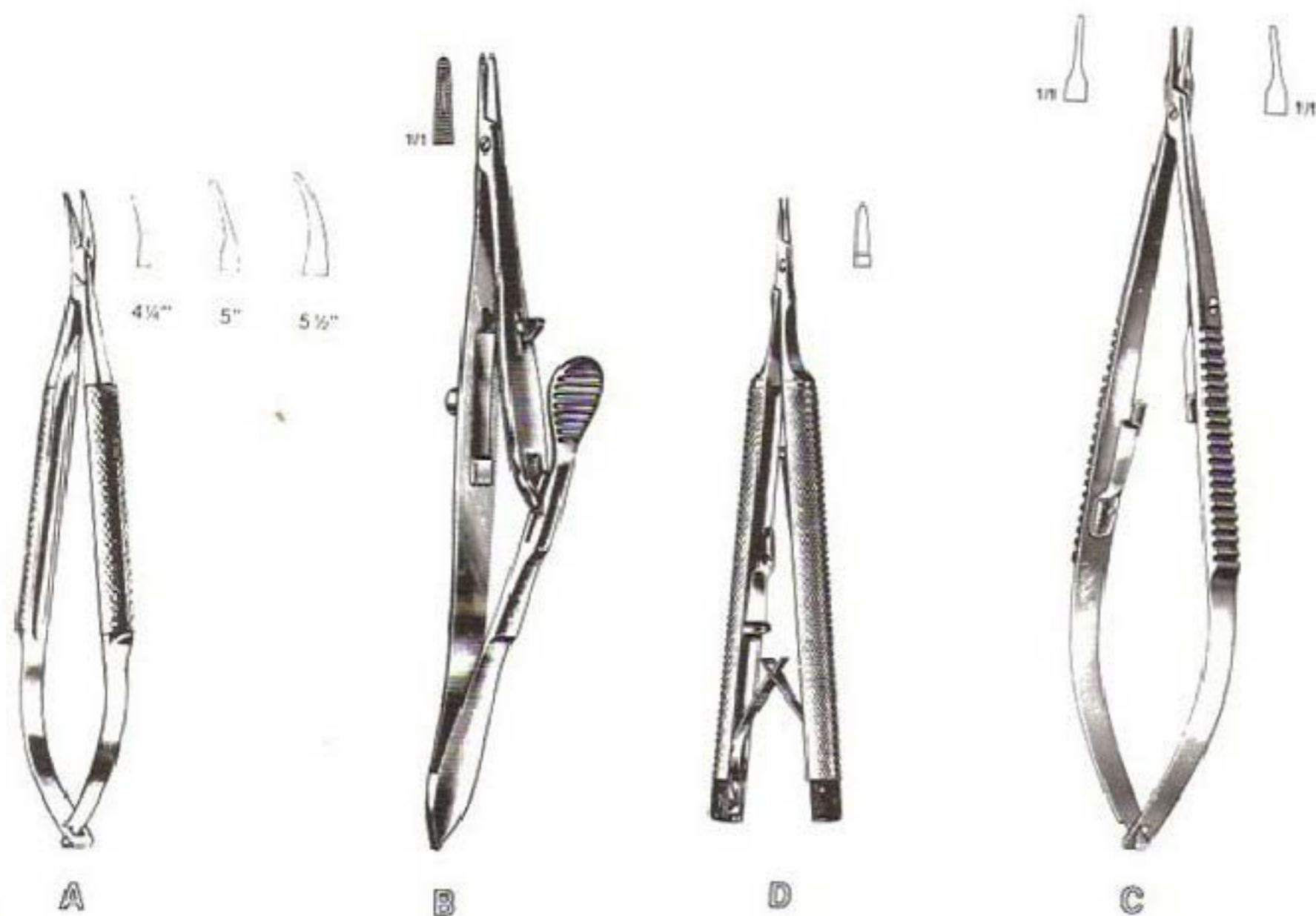

## EYE INSTRUMENTS

- |          |         |   |
|----------|---------|---|
| <b>A</b> | 746-562 | Barraquer Needle Holder, 5", Curved w/out Lock<br>10mm Wide Hollow Round Handle         |
|          | 746-563 | Barraquer Needle Holder, 5", Curved w/Lock<br>10mm Wide Hollow Round Handle             |
|          | 746-564 | Barraquer Needle Holder, 5 1/8", Curved, Delicate Tapered Jaws<br>8mm Wide Round Handle |
| <b>B</b> | 746-565 | Kalt Needle Holder, 5-1/4", standard model, delicate jaws                               |
| <b>C</b> | 746-566 | Castroviejo Needle Holder, 5 1/2", Straight w/Catch<br>Extra Delicate Jaws              |
|          | 746-567 | Castroviejo Needle Holder, 5 1/2" Curved w/Catch<br>Extra Delicate Jaws                 |
| <b>D</b> | 320-432 | Castroviejo Needle Holders, 5 1/4", Pen Type  |



### EYE INSTRUMENTS

- A 749-507 Schiottz Tonometer, in Case, Standard
- 749-515 Schiottz Tonometer, in Case, Improved, Inclined Scale
- 749-560 Schiottz Tonometer, in Case, with Allen Modification, Inclined Scale
  
- B 749-564 Eye Magnet, with Loop and Magnifier, in Case
- C 749-606 Foreign Body Magnet with Probe and Loop
  
- D 749-903 Fox Eye Shields, Package of 12
  
- E 749-952 Castroviejo Caliper, 3-1/2"
  
- F 021-210 Flexible Stainless Ruler, 6" x 1/2" Graduated in 1/32" Fraction

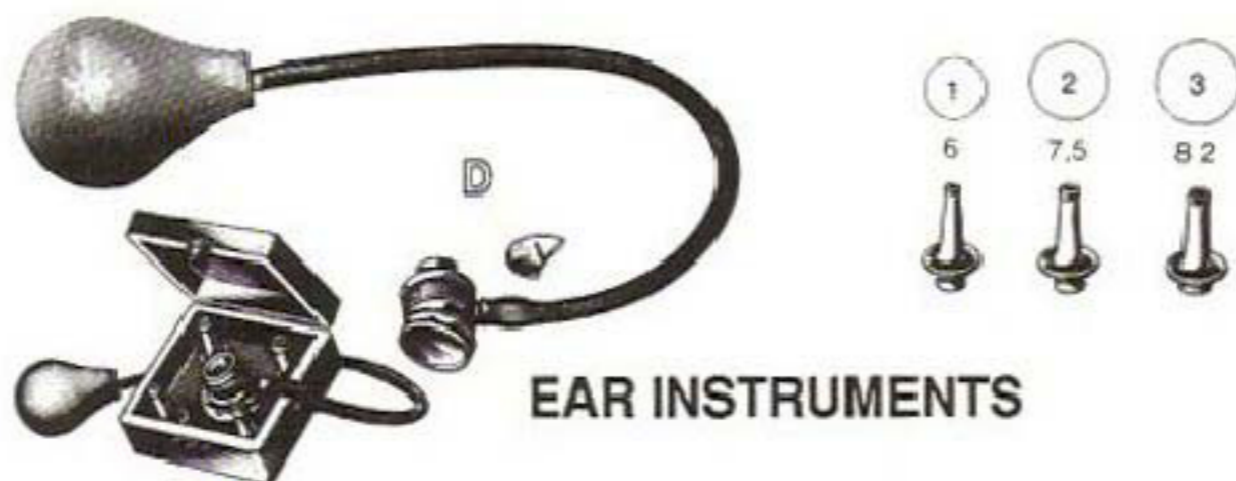

## EAR INSTRUMENTS

- A** 760-058 Boucheron Ear Specula, Chrome, Set of 4 - Round  
 760-066 Boucheron Ear Specula, Chrome, 4.5mm, Size 1  
 760-074 Boucheron Ear Specula, Chrome, 5.5mm, Size 2  
 760-082 Boucheron Ear Specula, Chrome, 6.4mm, Size 3  
 760-090 Boucheron Ear Specula, Chrome, 7.5mm, Size 4
- B** 760-306 Gruber Ear Specula, Chrome, Set of 4, Oval  
 760-314 Gruber Ear Specula, Oval, Chrome, 4x5mm, Size 1  
 760-322 Gruber Ear Specula, Oval, Chrome, 5x5mm, Size 2  
 760-330 Gruber Ear Specula, Oval, Chrome, 6x7mm, Size 3  
 760-335 Gruber Ear Specula, Oval, Chrome, 7x8mm, Size 4
- C** 760-405 Toynbee Ear Specula, Chrome, Set of 3 - Round  
 760-413 Toynbee Ear Specula, 4mm, Size 1  
 760-421 Toynbee Ear Specula, 5mm, Size 2  
 760-439 Toynbee Ear Specula, 6mm, Size 3
- D** 760-603 Bruening Pneumatic Magnifier Otoscope Set

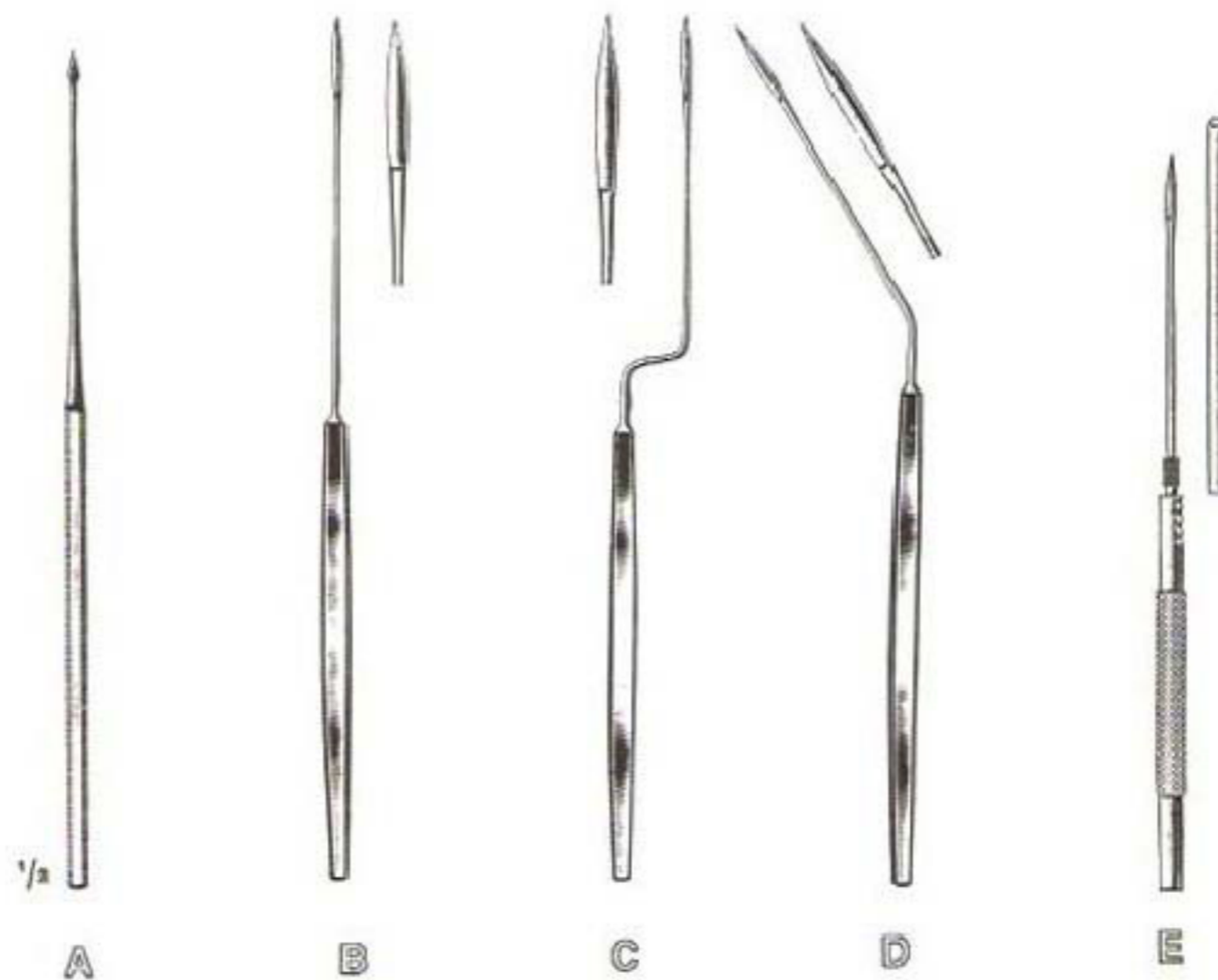

## EAR INSTRUMENTS

- A** 761-007 Buck Myringotomy Knife, Straight, 7"
- B** 761-254 Sexton Ear Knife, Straight, 7"
- C** 761-262 Sexton Ear Knife, Angled, 7"
- D** 761-270 Sexton Ear Knife, Bayonet, 7"
- E** 761-353 Friesner Ear Knife, in Case, 7-1/2"



762-492  
through  
762-534

00  
0  
1  
2  
3



762-003  
through  
762-039



762-690  
through  
762-732

00  
0  
1  
2  
3



762-294  
through  
762-336

## EAR INSTRUMENTS

762-492	Buck Ear Curette, Blunt, Straight, #00	762-690	Buck Ear Curette, Sharp, Straight, #00
762-500	Buck Ear Curette, Blunt, Straight, #0	762-708	Buck Ear Curette, Sharp, Straight, #0
762-518	Buck Ear Curette, Blunt, Straight, #1	762-716	Buck Ear Curette, Sharp, Straight, #1
762-526	Buck Ear Curette, Blunt, Straight, #2	762-724	Buck Ear Curette, Sharp, Straight, #2
762-534	Buck Ear Curette, Blunt, Straight, #3	762-732	Buck Ear Curette, Sharp, Straight, #3
762-003	Buck Ear Curette, Blunt, Angled, #00	762-294	Buck Ear Curette, Sharp, Angled, #00
762-005	Buck Ear Curette, Blunt, Angled, #0	762-302	Buck Ear Curette, Sharp, Angled, #0
762-013	Buck Ear Curette, Blunt, Angled, #1	762-310	Buck Ear Curette, Sharp, Angled, #1
762-021	Buck Ear Curette, Blunt, Angled, #2	762-328	Buck Ear Curette, Sharp, Angled, #2
762-039	Buck Ear Curette, Blunt, Angled, #3	762-336	Buck Ear Curette, Sharp, Angled, #3



## EAR INSTRUMENTS



- 762-914 Shapleigh (Freimuth) Ear Curette, Size 1, 6"
- 762-922 Shapleigh (Freimuth) Ear Cuette Size 2, 6"
- 762-003 Billeau Ear Loop, Small, 2.5mm, 6"
- 763-011 Billeau Ear Loop, Medium, 3mm, 6"
- 763-029 Billeau Ear Loop, Medium, 4mm, 6"
- 763-102 Gross Ear Hook and Spoon, 5 3/4"
- 764-001 Allport Incus Hook, 5 1/2"
- 764-010 Micro Alligator Ear Forceps, 3 1/4" (8.3cm) Shaft, Serrated Jaws 0.6mm Wide, Ebony Finish
- 764-015 Micro Alligator Ear Forceps, 3 1/4" (8.3cm) Shaft, Serrated Jaws 0.8mm Wide
- 764-020 Micro Alligator Ear Forceps, 3 1/4" (8.3cm) Shaft, Serrated Jaws 0.8mm Wide, Ebony Finish
- 764-025 Micro Alligator Ear Forceps, 3 1/4" (8.3cm) Shaft, Oval Cup Jaws 0.5mm Wide, Ebony Finish
- 764-030 Micro Alligator Ear Forceps, 3 1/4" (8.3cm) Shaft, Oval Cup Jaws 0.8mm Wide
- 764-035 Micro Alligator Ear Forceps 3 1/4" (8.3cm) Shaft, Oval Cup Jaws 0.8mm Wide, Ebony Finish
- 764-040 House Strut Forceps, 2 1/4" (7cm) Shaft, Smooth Jaws 0.8mm Wide
- 764-104 Bellucci Micro Ear Scissors, 2 3/4" (7cm) Shaft, 4mm Blades, Ebony Finish



### EAR INSTRUMENTS

- A** 765-008 Quire Mechanical Finger , 4"
- B** 765-057 Blake Ear Dressing Forceps, 4-1/4"
- C** 765-059 Wilde Ear Forceps, 5", Angled Serrated
- D** 765-107 Lucae Ear Forceps, 5-3/4"
- E** 765-156 Jansen Dressing Forceps, Bayonet Shape, 6-1/4"
- F** 765-160 DAY Ear Hook, 6-1/2" (16.5 cm), small size  
765-162 DAY Ear Hook, 6-1/2" (16.5 cm), large size





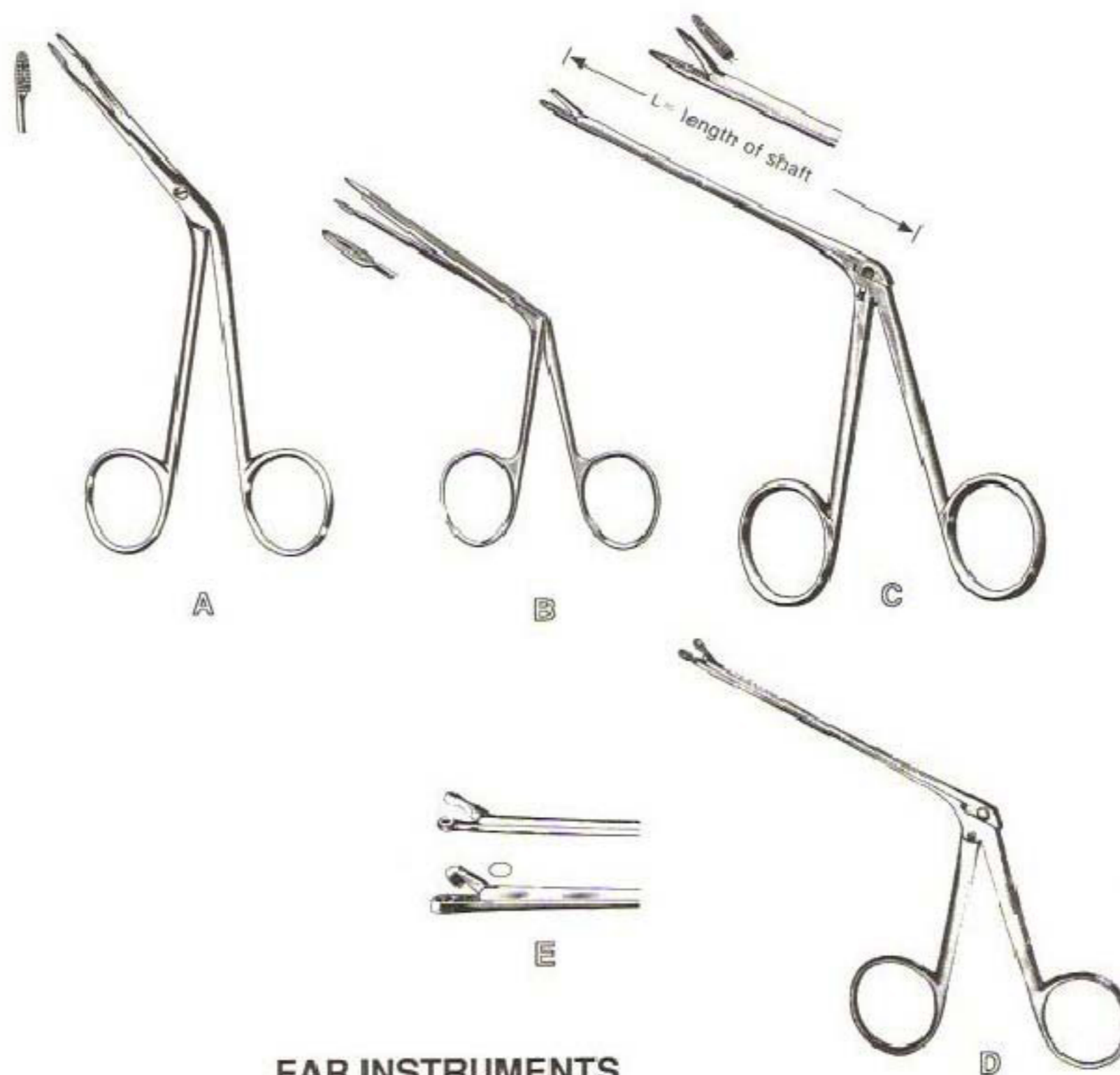

## EAR INSTRUMENTS

- A** 765-305 Hartman Ear Dressing Forceps, Delicate, 5" Serrated Jaws
- B** 765-404 Littauer Ear Dressing Forceps, 4-3/4" Serrated Jaws, Delicate
- C** 765-636 Hartman Alligator Ear Forceps (9cm) Shaft, 3-1/2"  
765-651 Hartman Alligator Ear Forceps (14cm) Shaft, 5-1/2"  
765-669 Hartman Alligator Ear Forceps (16.5cm) Shaft, 6-1/2"
- D** 765-701 Hartman Alligator Ear Forceps, Cupped Jaw, 3-1/2"
- E** 765-750 Hartman (Hoffman) Alligator Ear Forceps, Punch Action, 3-1/2"

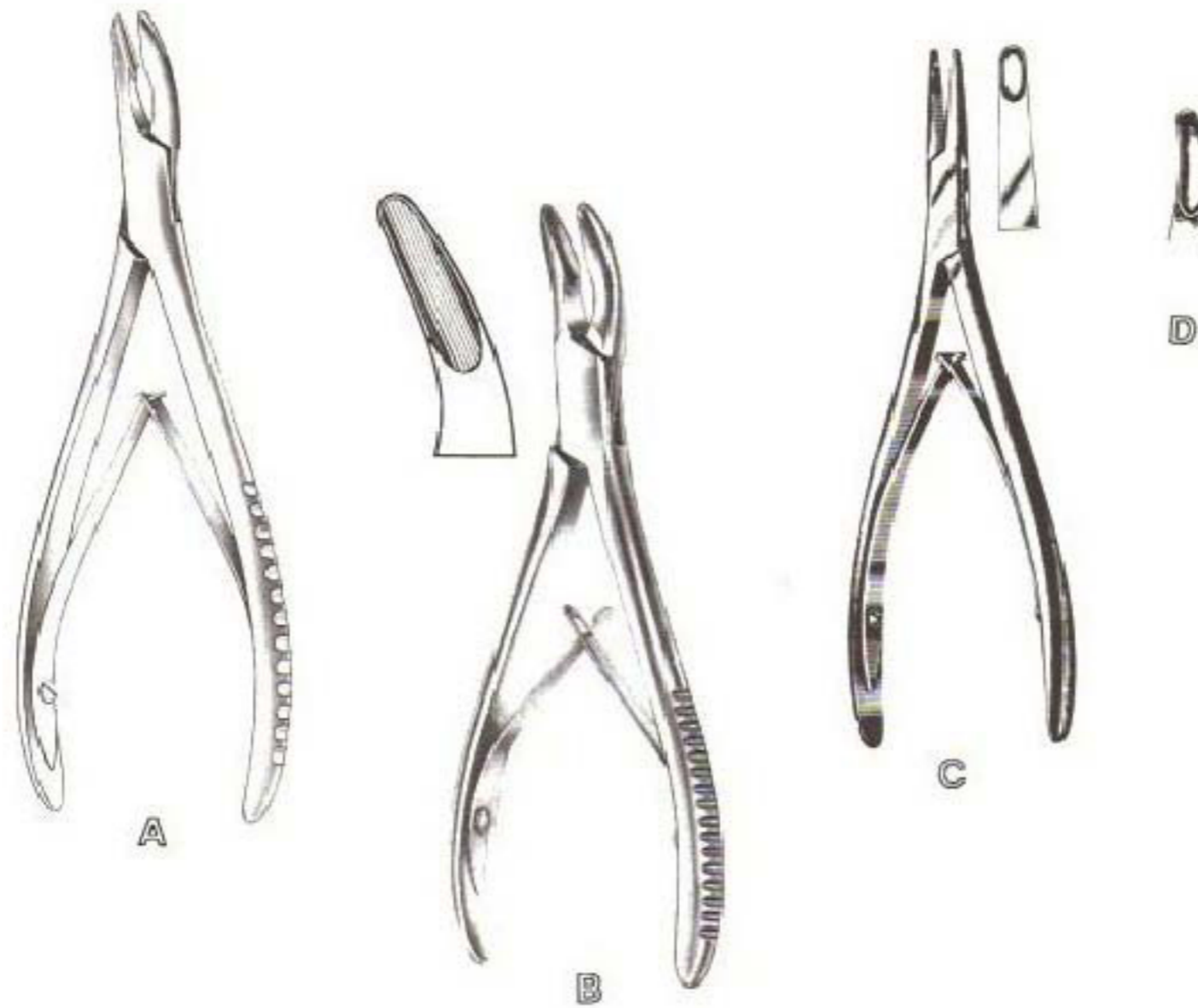

## EAR INSTRUMENTS

- |          |         |  |
|----------|---------|--|
| <b>A</b> | 702-258 | HARTMAN Mastoid Rongeur, 5-3/4" (14.6 cm), Strong Curve            |
| <b>B</b> | 765-805 | BANE Mastoid Rongeur, 7" (17.8 cm), Curved                         |
| <b>C</b> | 765-810 | LEMPERT Rongeur, 6-1/4" (15.9 cm), Straight, Delicate, 2.5 mm bite |
| <b>D</b> | 765-815 | LEMPERT Rongeur, 6-1/4" (15.9 cm), Curved, Delicate, 2.5 mm bite   |



B

## EAR INSTRUMENTS



A

A 766-006 Krause Ear Snare

767-004 Tuning Forks, Aluminum Alloy, Set of 5

B 767-053 Tuning Fork C-64 Vibrations

767-061 Tuning Fork C-128 Vibrations

767-079 Tuning Fork C-256 Vibrations

767-087 Tuning Fork C-512 Vibrations

767-095 Tuning Fork C-1024 Vibrations

767-103 Tuning Fork C-2048 Vibrations

767-111 Tuning Fork C-4096 Vibrations

C 768-028 Pomeroy Ear Syringe, 2 oz.

768-036 Pomeroy Ear Syringe, 3 oz.

768-044 Pomeroy Ear Syringe, 4 oz.



C

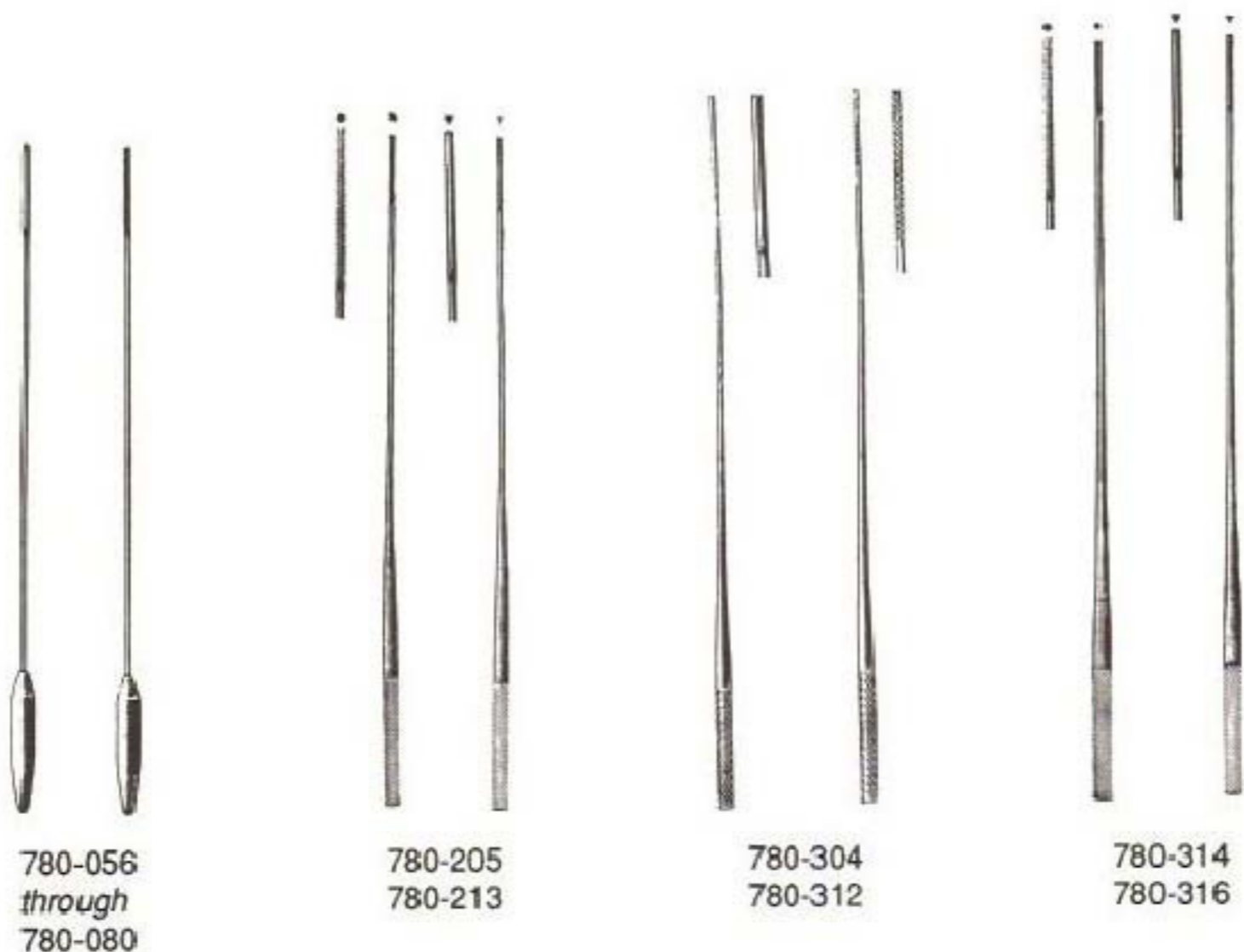

## APPLICATORS

- |         |  |
|---------|--|
| 780-056 | Brown Applicator, Triangular, Copper, 6"       |
| 780-064 | Brown Applicator, Triangular, Stainless, 6"    |
| 780-072 | Brown Applicator, Rough End, Copper, 6"        |
| 780-080 | Brown Applicator, Rough End, Stainless, 6"     |
| 780-205 | Lathbury Applicator, Rough End, 6-1/2"         |
| 780-213 | Lathbury Applicator, Triangular, 6-1/2"        |
| 780-304 | Uebe Applicator, Triangular, Stainless, 7-1/4" |
| 780-312 | Uebe Applicator, Rough End, Stainless, 7-1/4"  |
| 780-314 | Farrell Applicator, Twisted End, 6-1/2"        |
| 780-316 | Farrell Applicator, Triangle End, 6-1/2"       |



## NASAL INSTRUMENTS

- |          |         |   |
|----------|---------|---|
| <b>A</b> | 800-151 | Hartman Nasal Speculum, Medium 6"                           |
| <b>B</b> | 800-250 | Vienna Nasal Speculum, Small 5-3/4"                         |
|          | 800-268 | Vienna Nasal Speculum, Medium 5-3/4"                        |
|          | 800-276 | Vienna Nasal Speculum, Large 5-3/4"                         |
| <b>C</b> | 800-359 | Halle (Tieck) Infant Speculum 5-3/4"                        |
| <b>D</b> | 800-409 | Killian Septum Speculum, 6" w/Set Screw, 2" Long Blades     |
|          | 800-417 | Killian Septum Speculum, 6" w/Set Screw, 2-1/2" Long Blades |
|          | 800-425 | Killian Septum Speculum, 6" w/Set Screw, 3" Long Blades     |
|          | 800-433 | Killian Septum Speculum, 6" w/Set Screw, 3-1/2" Long Blades |
| <b>E</b> | 800-435 | Beckman Nasal Speculum, 6"<br>Angled on Side                |



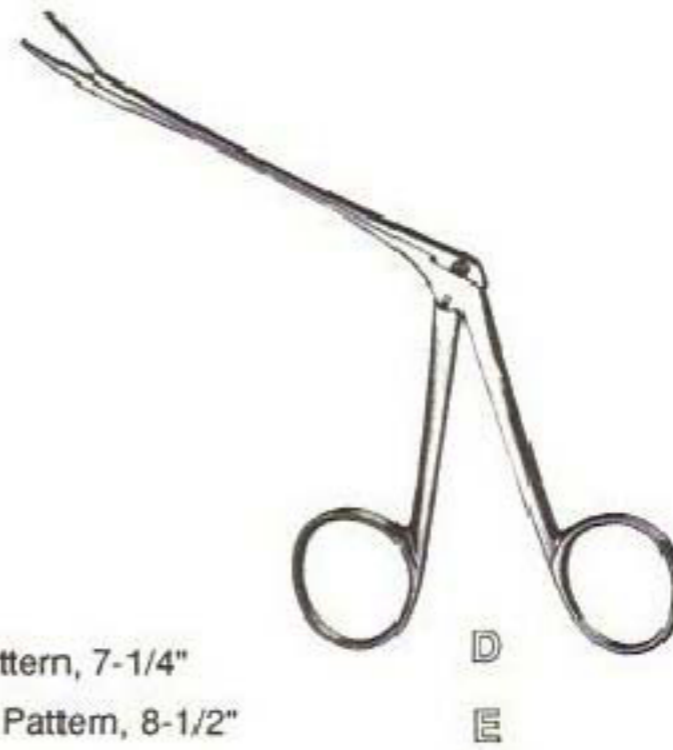

## NASAL INSTRUMENTS

- 800-508 Gruenwald Nasal Forceps, 8"
- 800-557 Wilde Nasal Dressing Forceps, 7"
- 800-607 Hartman Nasal Dressing Forceps, Light Pattern, 7-1/4"
- 800-615 Hartman Nasal Dressing Forceps, Regular Pattern, 8-1/2"
- 800-656 Noyes Alligator Forceps, Serrated Jaws, 5.5" Shaft
- 800-660 Noyes Alligator Forceps, 1x2 T, 5.5" Shaft

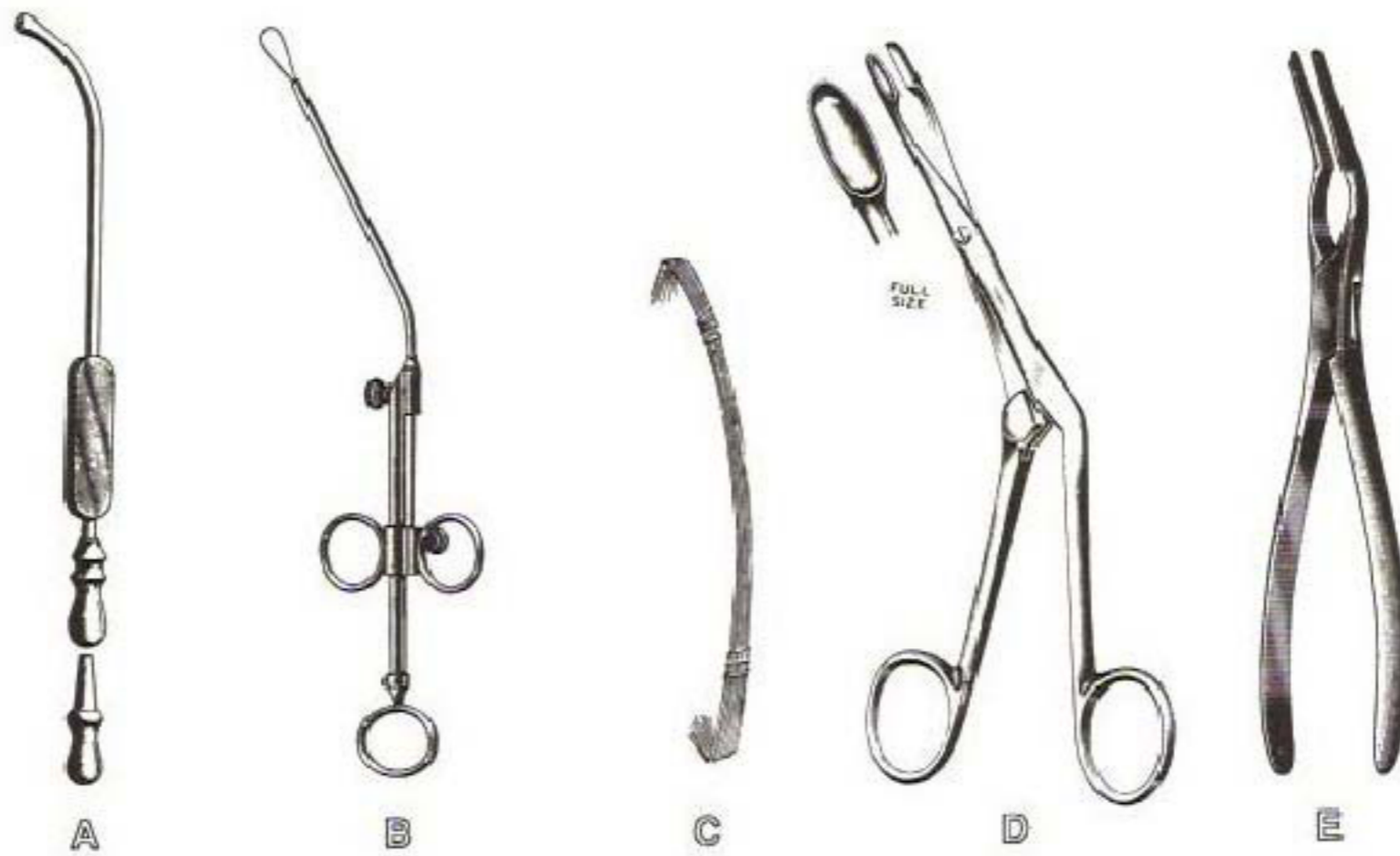

## NASAL INSTRUMENTS

- A** 801-506 Killian (Eiken) Antrum Canula, 3mm, Chrome
- B** 802-009 Krause Nasal Snare 10"  
802-017 Krause Nasal Snare, Stylette Only
- C** 802-058 Cut Snare Wire, Package of 12, Size 5  
802-066 Cut Snare Wire, Package of 12, Size 6
- D** 803-007 Knight Septum Cutting Forceps, 7"
- E** 803-056 Asch Septum Straightening Forceps, 8-3/4"
- F** 803-155 Takahashi Nasal Forceps, 5-1/2" Shaft



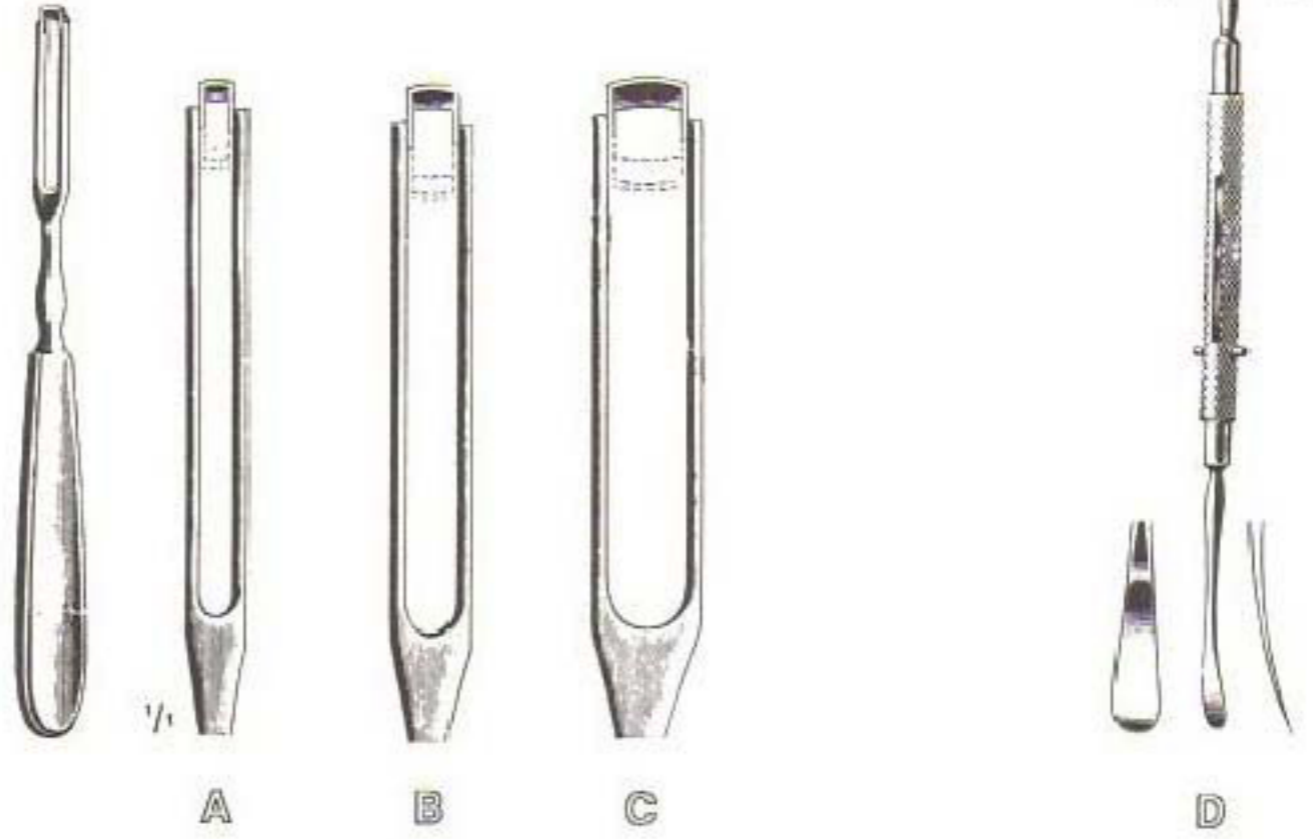

## NASAL INSTRUMENTS

- |          |         |  |
|----------|---------|--|
| <b>A</b> | 803-239 | Ballenger Swivel Knife, 3mm, 7-3/4"                      |
| <b>B</b> | 803-247 | Ballenger Swivel Knife, 4mm, 7-3/4"                      |
| <b>C</b> | 803-254 | Ballenger Swivel Knife, 5mm, 7-3/4"                      |
| <b>D</b> | 803-353 | Freer Septum Elevator, Double Ended, Sharp/Blunt, 7-1/2" |





## PLASTIC SURGERY INSTRUMENTS

- A** 803-400 Cottle Rasp 8" (20.3cm), Backward Cutting
- B** 803-405 Maltz Rasp 7" (17.8cm), Backward Cutting
- C** 803-410 Maltz Rasp 8 ¼" (21cm), Improved Double End Pattern  
One end forward, other end backward cutting
- D** 803-415 Aufricht Giabella Rasp 8 ¼" (21cm), Curved Blade, Forward Cutting
- 803-420 Aufricht Giabella Rasp 8 ¼" (21cm), Curved Blade, Backward Cutting

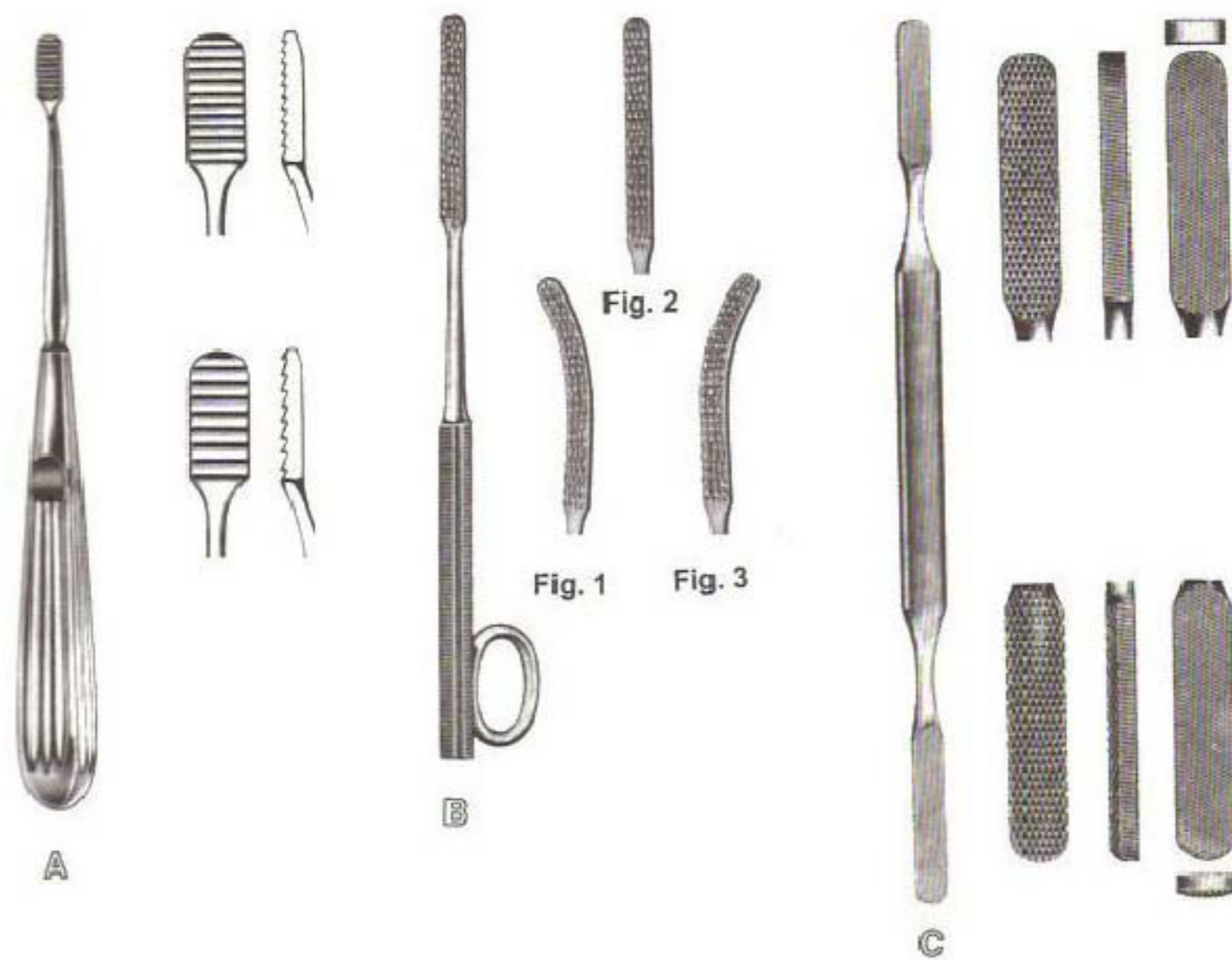

## PLASTIC SURGERY INSTRUMENTS

- A** 803-425 Lewis Rasp 7 ½" (19.1 cm), Fine Teeth, Backward Cutting  
803-430 Lewis Rasp 7 ½" (19.1 cm), Coarse Teeth, Backward Cutting
- B** 803-435 Gallaher Rasp 6 ½" (16.5cm), Coarse Teeth, Convex  
803-440 Gallaher Rasp 6 ½" (16.5 cm), Coarse Teeth, Fig. 1  
803-445 Gallaher Rasp 6 ½" (16.5 cm), Coarse Teeth, Fig. 2  
803-450 Gallaher Rasp 6 ½" (16.5 cm), Coarse Teeth, Fig. 3
- C** 823-485 Foman Rasp 8 ¼" (21 cm) Double End, 4 sided,  
Fine and Coarse Teeth, Both in Flat and Convex
- 823-490 Foman Rasp 8 ¼" (21 cm) Double End, Coarse Teeth Flat and Convex  
823-500 Foman Rasp 8 ¼" (21 cm) Double End, Fine Teeth Flat and Convex



## ORAL INSTRUMENTS

- |          |         |   |
|----------|---------|---|
| <b>A</b> | 804-100 | Blumenthal Oral Surgery Rongeur 6" (15.2 cm), Beaks at 30° Angle                |
| <b>B</b> | 804-105 | Blumenthal Oral Surgery Rongeur 7" (17.8 cm), Beaks at 30° Angle                |
| <b>C</b> | 804-110 | Blumenthal Oral Surgery Rongeur 6" (15.2 cm), Beaks at 90° Angle                |
| <b>D</b> | 804-112 | Mini-Blumenthal Oral Surgery Rongeur 4 ½" (11.4 cm), Beaks at 30° Angle         |
| <b>E</b> | 702-159 | Meade Oral Surgery Rongeur 6 ½" (16.5 cm), No. 1A Pattern Slightly Angled Beaks |

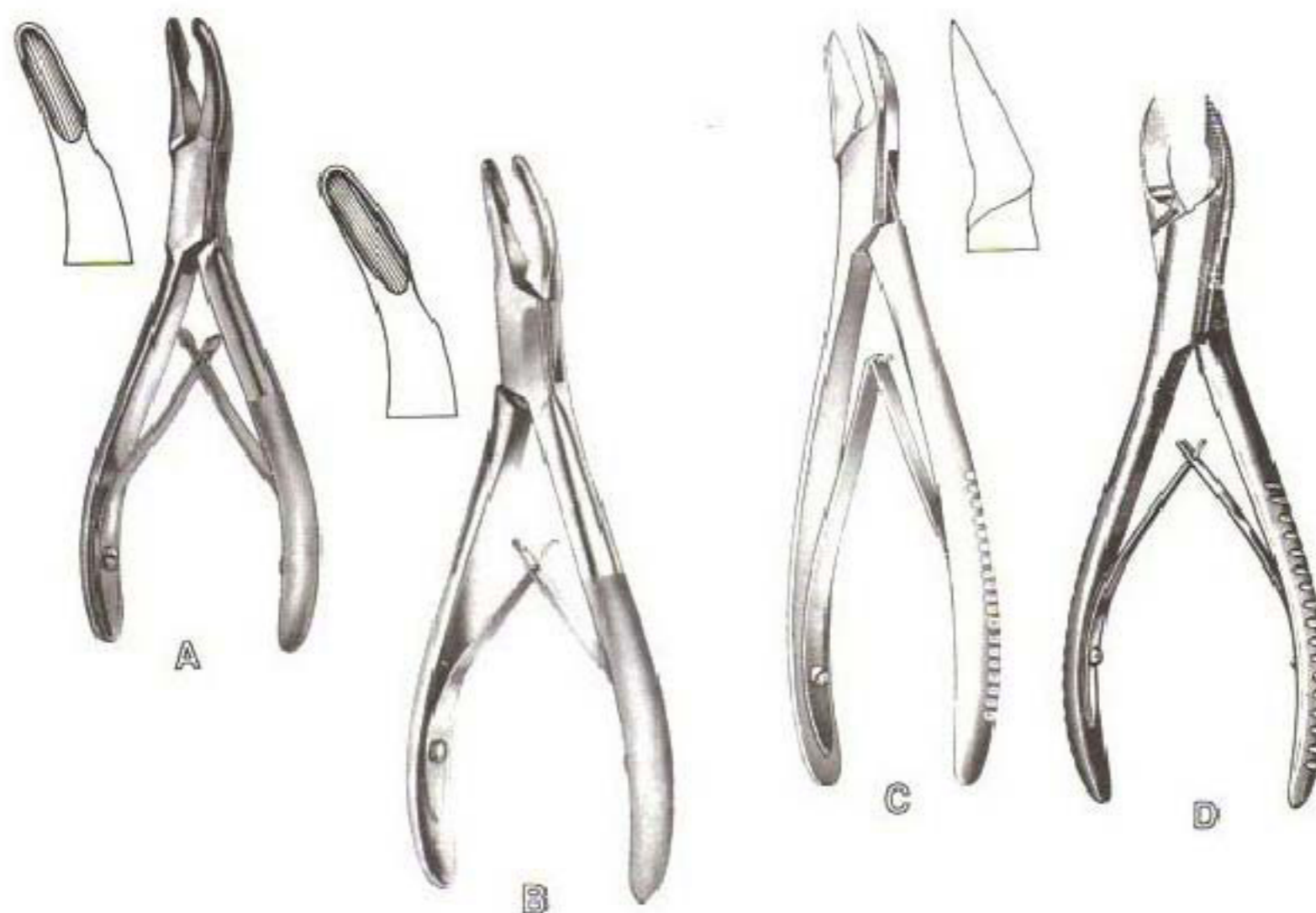

## ORAL INSTRUMENTS

- |          |         |   |
|----------|---------|---|
| <b>A</b> | 804-115 | Oral Surgery Rongeur, 5 ½" (14 cm), No. 4 Pattern, Slightly Curved Beaks            |
| <b>B</b> | 804-120 | Oral Surgery Rongeur, 6 ½" (16.5 cm), No. 4A Pattern, Slightly Curved Beaks         |
| <b>C</b> | 804-125 | Oral Surgery Rongeur, 6 ¾" (17.1 cm), No. 5 Pattern, Side Cutting, Slightly Curved  |
| <b>D</b> | 804-130 | Oral Surgery Rongeur, 6 ½" (16.5 cm), No. 5A Pattern, Side Cutting, Slightly Curved |

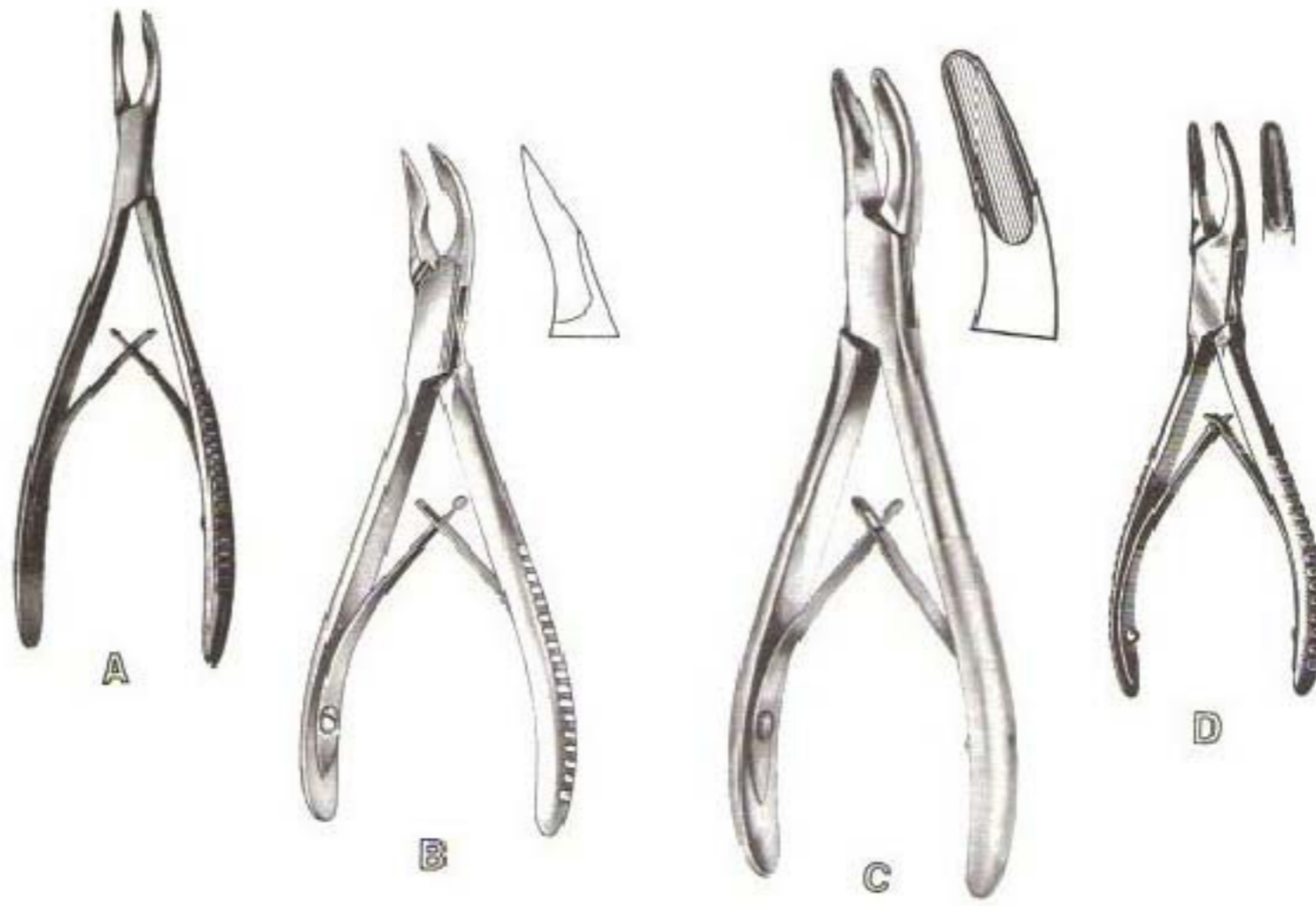

## ORAL INSTRUMENTS

- A** 804-135 Micro FRIEDMAN Rongeur, 5-1/2" (14 cm), straight, 1.3 mm wide jaws, very delicate
- 804-140 Micro FRIEDMAN Rongeur, 5-1/2" (14 cm), curved, 1.3 mm wide jaws, very delicate
- B** 804-145 Micro FRIEDMAN Rongeur, 5-1/2" (14 cm), 90 degree angled 1.3 mm wide jaws, very delicate
- C** 804-147 Oral Surgery Rongeur, 6" (16.5 cm), no. 5S pattern, Side cutting, slightly curved
- 804-150 Oral Surgery Rongeur, 6-1/2" (16.5 cm), no. 1 pattern, strong curved beaks
- D** 804-155 FRIEDMAN Oral Surgery Rongeur, 5-1/2" (14 cm), very delicate, slightly curved beaks



## ORTHOPEDIC INSTRUMENTS

- |          |  |  |
|----------|--|--|
| <b>A</b> | 700-807<br>804-158<br>700-815<br>804-162 | Liston Bone Cutting Forceps 5 ½" (14 cm), Straight<br>Liston Bone Cutting Forceps 6 ¾" (17 cm), Straight<br>Liston Bone Cutting Forceps 7 ½" (19.1 cm), Straight<br>Liston Bone Cutting Forceps 8 ¾" (22.2 cm), Straight                         |
| <b>B</b> | 804-164<br>804-166<br>804-168<br>804-170 | Liston Bone Cutting Forceps 5 ½" (14 cm), Angled on Flat<br>Liston Bone Cutting Forceps 6 ¾" (17 cm), Angled on Flat<br>Liston Bone Cutting Forceps 7 ½" (19.1 cm), Angled on Flat<br>Liston Bone Cutting Forceps 8 ¾" (22.2 cm), Angled on Flat |
| <b>C</b> | 701-052<br>700-757<br>700-768            | Ruskin Bone Cutting Forceps 5 ½" (14 cm), Straight<br>Ruskin Bone Cutting Forceps 7 ½" (19.1 cm), Straight<br>Ruskin Bone Cutting Forceps 7 ½" (19.1 cm), Straight<br>Delicaté Blades  |
| <b>D</b> | 701-060<br>700-765                       | Ruskin Bone Cutting Forceps, 5 ½" (14 cm), Angled<br>Ruskin Bone Cutting Forceps, 7 ½" (19.1 cm), Angled   |
| <b>E</b> | 804-186                                  | Liston-Blau Bone Cutting Forceps, 5.1/2" (14 cm), Narrow<br>Straight Blades  |

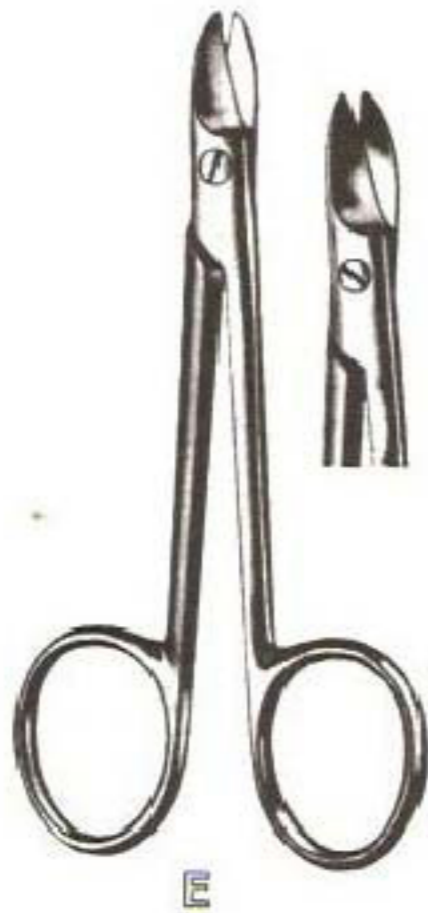

## RHINOPLASTIC INSTRUMENTS

- |          |         |   |
|----------|---------|---|
| <b>A</b> | 825-260 | Knight Nasal Scissors, 6 3/4" (17.1cm) Angled on side<br>Standard Pattern |
| <b>B</b> | 825-265 | Heyman Nasal Scissors, 6 3/4" (17.1cm) Angled on side<br>Rounded Blades   |
| <b>C</b> | 825-270 | Seiler Turbinate Scissors, 6 1/4" (15.9cm) Angled on side                 |
| <b>D</b> | 822-156 | Quimby Scissors, 5", (12.7cm) Blades 15mm,<br>Strongly Curved and Pointed |
| <b>E</b> | 822-304 | Wire Cutting Scissors, 4 3/4" (12.1cm), Straight<br>1 Blade Serrated      |
|          | 822-353 | Wire Cutting Scissors, 4 3/4" (12.1cm), Curved<br>1 Blade Serrated        |



## RHINOPLASTIC INSTRUMENTS

- 823-104 FOMON Retractor, 6-1/2" (16.5 cm), two prongs with ball tips, 11 mm wide
- 823-203 COTTLE Retractor, 5-1/2" (14 cm), 4 blunt prongs, 2 center prongs recessed
- 823-302 AUFRICHT Retractor-Speculum, 6-1/2" (16.5 cm), solid blade
- 823-401 JOSEPH Rasp, 6-1/4" (15.9 cm), fine cross serrations
- 823-404 JOSEPH Nasal Saw, 7-1/2" (19.1 cm), straight
- 823-406 JOSEPH Nasal Saw, 7-1/2" (19.1 cm), bayonet right
- 823-408 JOSEPH Nasal Saw, 7-1/2" (19.1cm), bayonet left
- 803-353 FREER Elevator, 7" (17.8 cm), double end sharp and blunt blades 5 mm wide



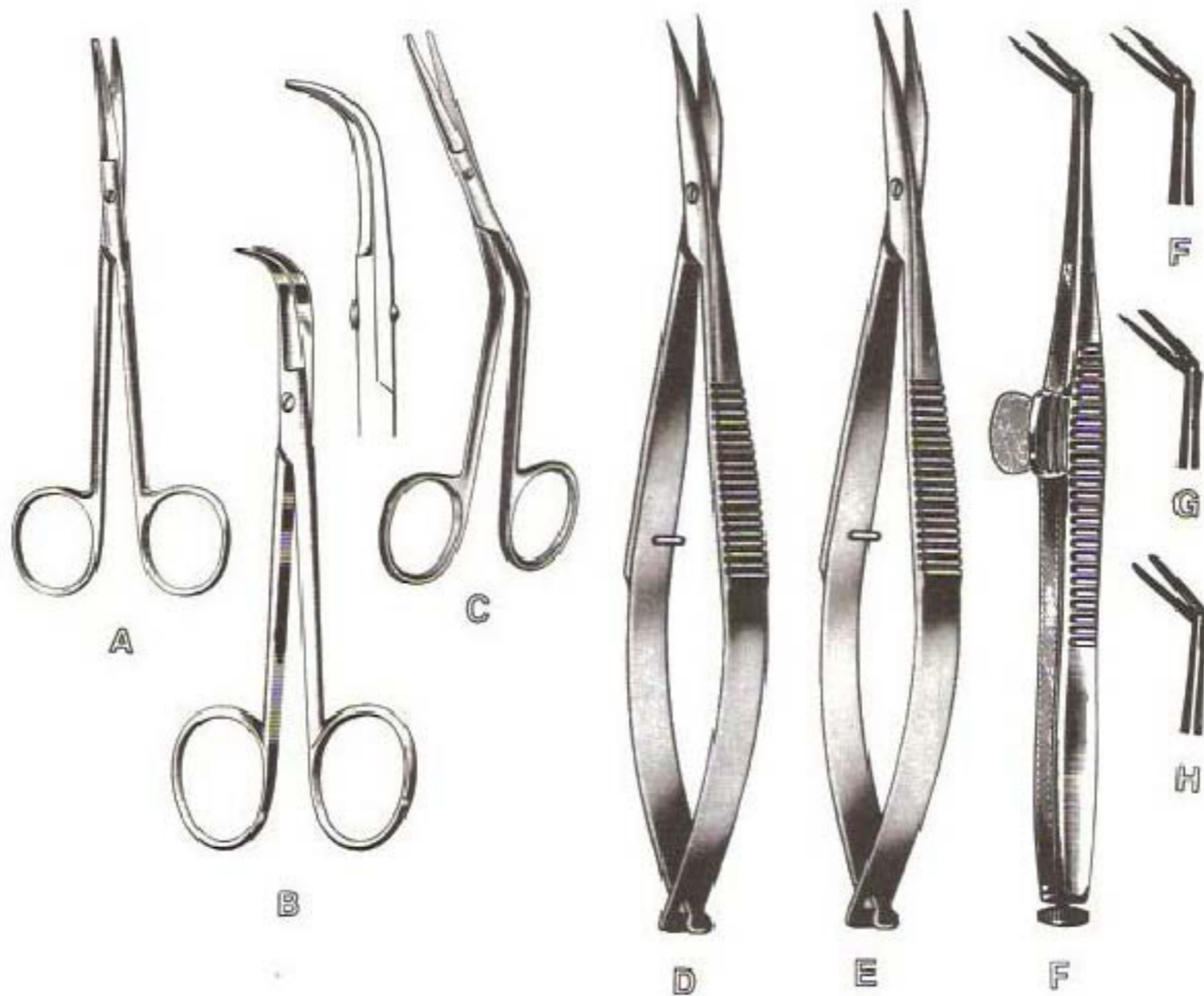

## OPERATING SCISSORS

- |          |         |  |
|----------|---------|--|
| <b>A</b> | 822-104 | Foman Saber-Back 5" (12.7 cm) Slightly Curved Blades with Semi-Sharp Outer Edges Used for Dissection |
| <b>B</b> | 822-106 | Foman Lower Lateral Scissors 5" (12.7 cm), Strong Curve, Dissecting Blades                           |
| <b>C</b> | 822-155 | Foman Dorsal Scissors 5 ½" (14 cm), Light Pattern, Angular Shanks                                    |
| <b>D</b> | 745-060 | Westcott Stitch Scissors 4 ½" (11.4 cm), Curved, Sharp Points  |
| <b>E</b> | 745-065 | Westcott Utility Scissors 4 ½" (11.4 cm), Curved Blunt Tips  |
| <b>F</b> | 745-070 | DeWecker Iris Scissors 4 ¼" (10.8 cm), Angled 7mm Blades Sharp/Sharp Points                          |
| <b>G</b> | 745-075 | DeWecker Iris Scissors 4 ¼" (10.8 cm), Angled 7mm Blades Sharp/Blunt Points                          |
| <b>H</b> | 745-080 | DeWecker Iris Scissors 4 ¼" (10.8 cm), Angled 7mm Blades Blunt/Blunt Points                          |



## OPERATING SCISSORS

- |   |         |  |
|---|---------|--|
| A | 822-160 | Cuttle Dorsal Scissors 6 ½" (16.5 cm), Heavy Pattern with Rounded Blades, Angular Shanks                   |
| B | 822-165 | Gorney Septal Scissors 7 ¾" (19.7 cm), Double Action Angled Handle, Serrated Blades with 1 ¾" (4.4 cm) cut |
| C | 822-170 | Caplan Nasal Bone Scissors 8" (20.3 cm), Double Action, Straight, Serrated Blades                          |
| D | 822-175 | Caplan Nasal Bone Scissors 8" (20.3cm), Double Action, Angled Handle Serrated Blades                       |



### OPERATING SCISSORS

- A 822-180 DUBOIS Scissors, 10-1/2" (26.7 cm), Straight, extra heavy pattern, blunt points
- B 822-185 DUBOIS Scissors, 10-1/2" (26.7 cm), curved, extra heavy pattern, blunt points
- C 822-190 Ingrown Nail Splitting Scissors, 6" (15.2 cm), Straight, One Serrated Blade
- D 822-198 Nail Scissors, 3-1/2" (8.9 cm), Straight blades
- 822-200 Nail Scissors, 3-1/2" (8.9 cm), curved blades
- E 822-202 Cuticle Scissors, 3-1/2" (8.9 cm), Straight blades
- 822-205 Cuticle Scissors, 3-1/2" (8.9 cm), curved blades
- F 822-208 Cuticle Scissors, 3-1/2" (8.9 cm), Straight blades, extra delicate
- 822-210 Cuticle Scissors, 3-1/2" (8.9 cm), curved blades, extra delicate



824-003



824-607



824-904



825-250



825-255

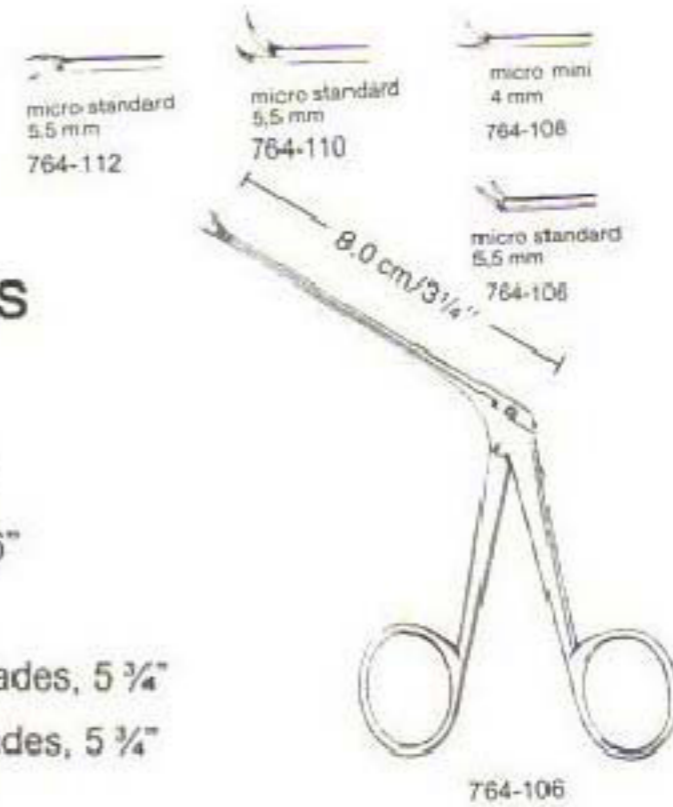

## RHINOPLASTIC INSTRUMENTS

- 824-003 Hajek Mallet, 16mm Bronze Head, 8oz, 8 1/4"
- 824-607 Joseph Button End Knife, 2mm wide Blade, 6"
- 824-904 Cottle-Kazanjian Rongeur, 7 1/2"
- 825-250 Joseph Nasal Scissors, Straight, Serrated Blades, 5 3/4"
- 825-255 Joseph Nasal Scissors, Curved, Serrated Blades, 5 3/4"
- 825-260 Knight Nasal Scissors, 6 3/4", Angled on side
- 764-104 Bellucci Micro Ear Scissors, 2 3/4" Shaft, 4mm Blade
- 764-106 Bellucci Micro Ear Scissors, 3 1/4" Shaft, Cutting Blade Curved up 4mm
- 764-108 Bellucci Micro Ear Scissors 3 1/4" Shaft, Cutting Blade Curved up 3mm
- 764-110 Bellucci Micro Ear Scissors, 3 1/4" Shaft, Cutting Blade, Right Curved, 5.5mm
- 764-112 Bellucci Micro Ear Scissors, 3 1/4" Shaft, Cutting Blade, Left Curved, 5.5mm



## ANESTHESIA INSTRUMENTS

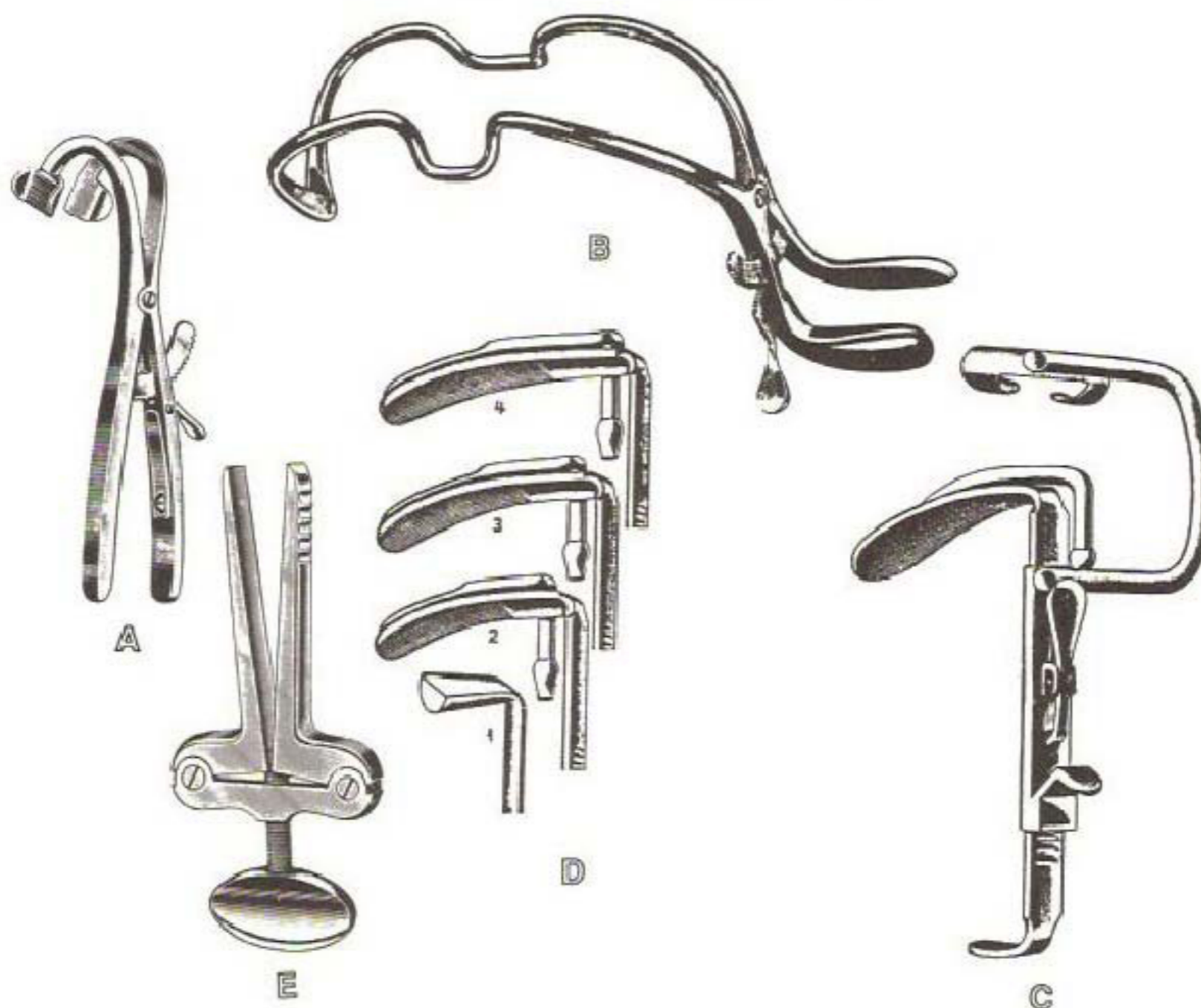

- A** 840-173 Denhardt Mouth Gag 5" (12.7 cm) with Grip Lock
- B** 840-231 Jennings Mouth Gag, Infant Size, 3-3/4" (9.5 cm) Wide  
 840-249 Jennings Mouth Gag, Child Size, 4-3/4" (12.1 cm) Wide  
 840-256 Jennings Mouth Gag, Adult Size, 6" (15.2 cm) Wide
- C** 840-306 Davis Mouth Gag 6-1/4" (15.9) Double Bite, Left, without Blades  
 840-355 Davis Mouth Gag 6-1/4" (15.9) Double Bite, Right, without Blades
- E** 840-450 Heister

**D**

BLADES FOR DAVIS OR McIVOR MOUTH GAGS					
W/Ether Tube	No.	Size		W/O Ether Tube	
840-413A	1	3/4" X 1", (1.9 X 2.5 cm)	tooth plate	840-413	
840-421A	2	1" X 2-3/4", (2.5 X 7 cm)	tongue blade	840-421	
840-439A	3	1" X 3-1/4" (2.5 X 8.3 cm)	tongue blade	840-439	
840-447A	4	1" X 3-3/4" (2.5 X 9.5 cm)	tongue blade	840-447	
840-448A	5	1" X 4" (2.5 X 10.2 cm)	tongue blade	840-448	



## ORAL INSTRUMENTS

- A** 840-108 Wieders Tongue Depressor, Small Blade, 28mm wide, Serrated  
840-116 Wieders Tongue Depressor, Large Blade, 36mm wide, Serrated
- B** 840-118 Bosworth Tongue Depressor, Fenestrated Blade 25mm wide
- C** 840-120 Cheek Retractor, 7 ¾" (19.7cm) with Swivel Blade 35mm wide
- D** 840-058 Andrew Tongue Depressor, Serrated Blade 21mm wide
- E** 840-128 Tongue Depressor 6 ¾" (17.1cm) Double End  
20mm and 25mm wide, Cross Serrated
- F** 840-132 Tobold Tongue Depressor(14.5cm) 5 ¾", Serrated Blade
- G** 840-136 University of Minnesota Cheek Retractor, 5 ½" (14cm)  
Double End 14mm and 20mm wide



**ORAL INSTRUMENTS**

- A** 840-200 Tongue Cleaner, Stainless
- B** Ring Tongue Retractor Blades  
For use with Davis or McIvor Mouth Gags  
Grooved Blade holds Endotracheal Tube firmly in place

Left	Size No.	Size	Right
840-210	2	1 1/8 x 2 1/4" (2.2 x 5.7cm) Tooth Plate	840-218
840-212	3	1 1/8" x 3" (2.9 x 7.6cm) Tongue Blade	840-220
840-214	4	1 1/4" x 3 1/2" (3.2 x 8.9cm) Tongue Blade	840-222
840-216	5	1 1/2" x 3 1/4" (3.8 x 9.5cm) Tongue Blade	840-224

- C** 840-258 Blair Cleft Palate Elevator 7 3/4" (19.7cm) L-Shape, Blunt  
840-259 Blair Cleft Palate Elevator 7 3/4" (19.7cm) Right Angle, Semi Sharpe Tip  
840-260 Blair Cleft Palate Elevator 8" (20.3cm) Curved Blade, Blunt

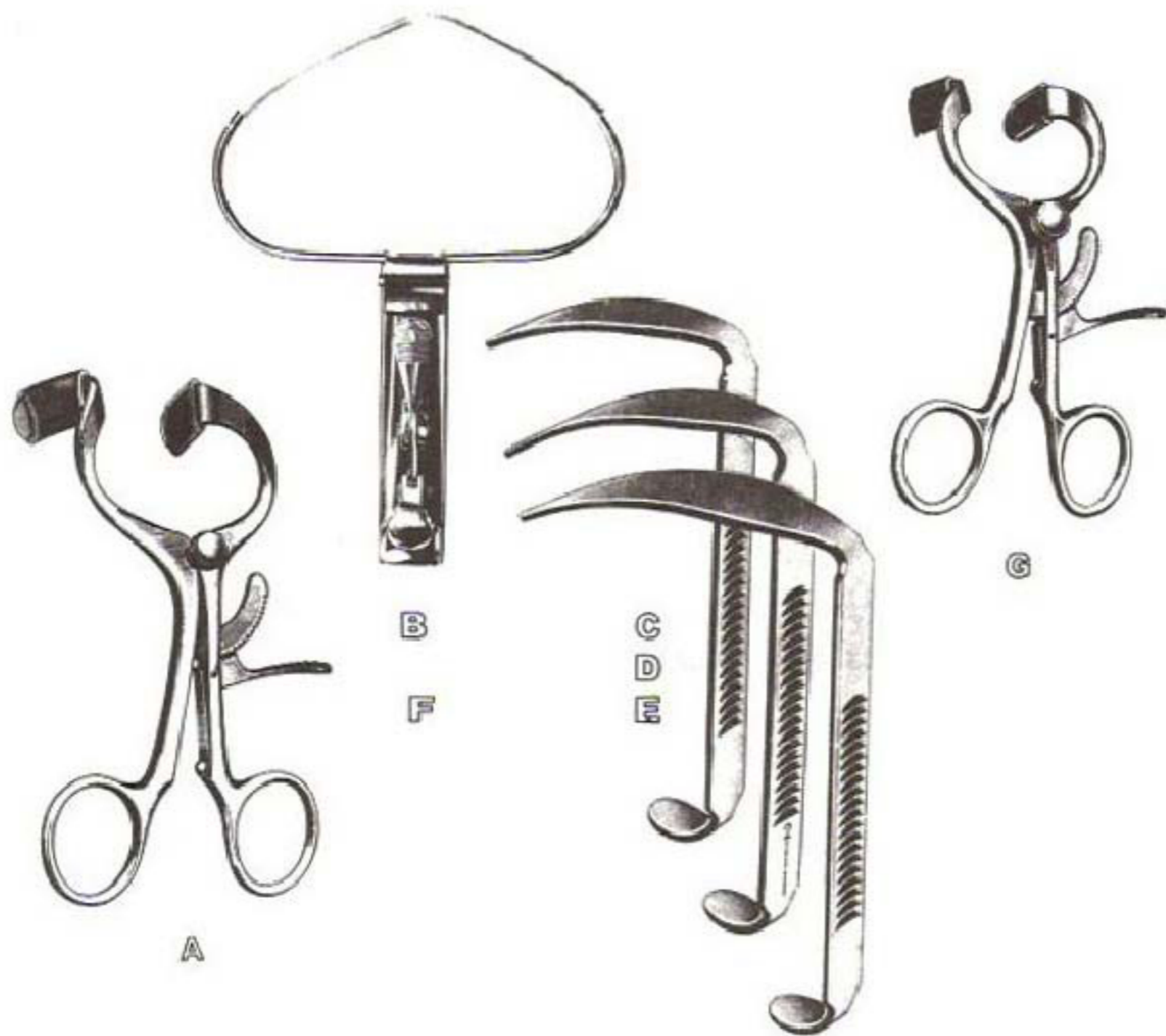

## ORAL SURGERY INSTRUMENTS

<b>A</b>	840-500	Doyen - Jansen Mouth Gag 5-1/2" (14 cm) with Grip Lock
<b>B</b>	840-504	McIvor Mouth Gag, Complete with 3 Blades
<b>C</b>	840-512	McIvor Blade Only, Small, 1 x 2-3/4" (2.5 x 7 cm)
<b>D</b>	840-520	McIvor Blade Only, Medium, 1 x 3-1/4" (2.5 x 8.3 cm)
<b>E</b>	840-538	McIvor Blade Only, Large, 1 x 3-3/4" (2.5 x 9.5 cm)
<b>F</b>	840-546	McIvor Frame and Handle Only
<b>G</b>	840-550	Molt Mouth Gag with Silicone Guards, Pediatric 4" (10.7cm)
	840-555	Molt Mouth Gag with Silicone Guards, Child ( 1.4cm)
	840-560	Molt Mouth Gag with Silicone Guards, Adult 5-1/2" (14cm)





## ORAL INSTRUMENTS

- A** 840-600 Kilner-Doughty Mouth Gag Complete with 3 Blades
  
- B** 840-650 Kilner-Doughty Blade Only, 60 x 25mm  
840-654 Kilner-Doughty Blade Only, 75 x 32mm  
840-658 Kilner Doughty Blade Only, 80 x 37mm
  
- C** 840-751 Hurd Tonsil Dissector and Pillar Retractor, Standard Model, 8 ¼"
- D** 840-801 Hurd Tonsil Dissector and Pillar Retractor, Serrated Edge, 8 ¼"
  
- E** 840-850 Wieder Pillar Retractor, 7"

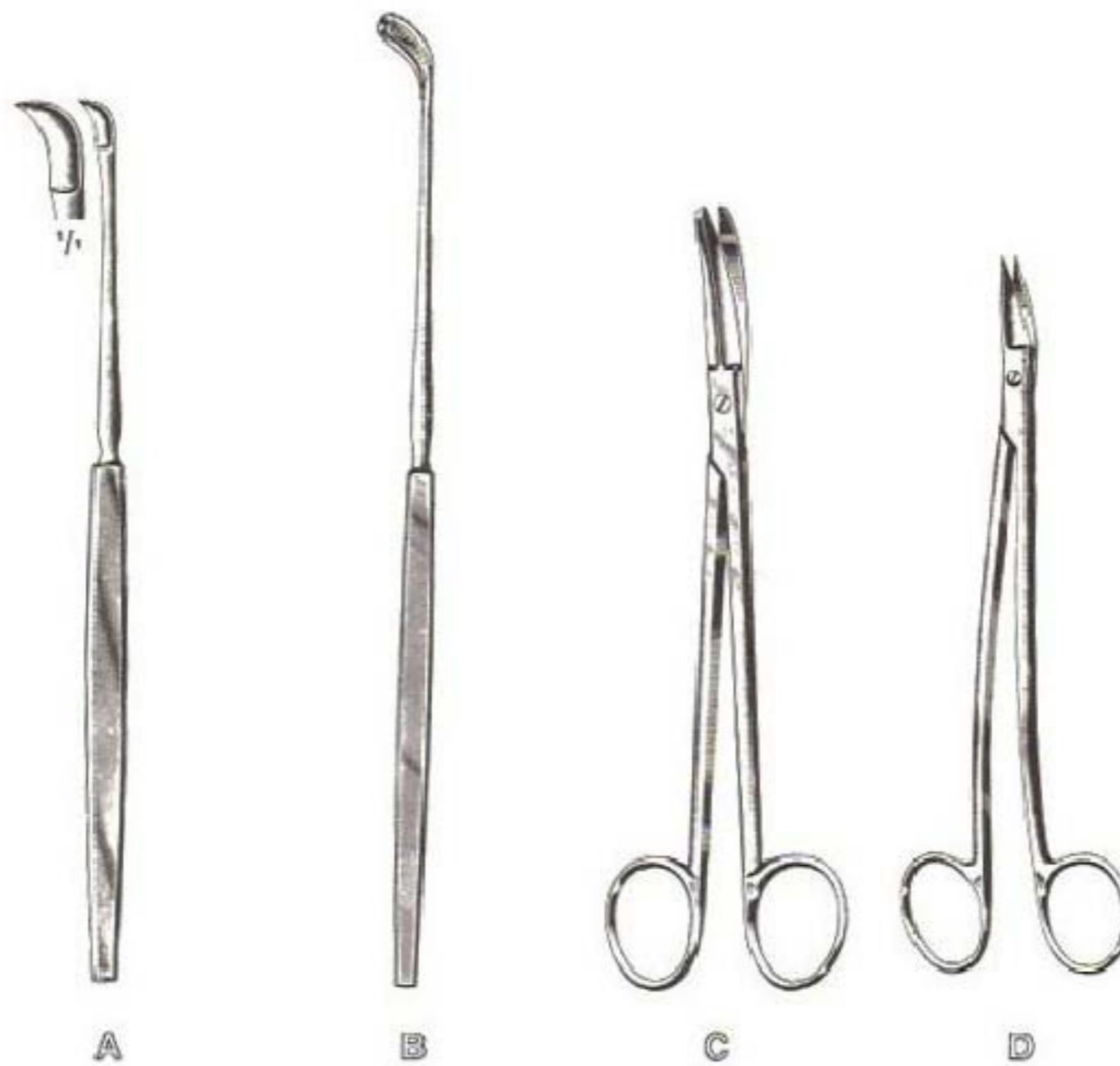

## TONSIL and ADENOID INSTRUMENTS

- A 841-007 Canfield Tonsil Knife, 7-1/2"
- B 841-056 Fisher Tonsil Knife, 9"
- C 842-005 Boettcher Tonsil Scissors, 7-1/4"
- D 842-054 Dean Tonsil Scissors, Serrated Edge, 7"

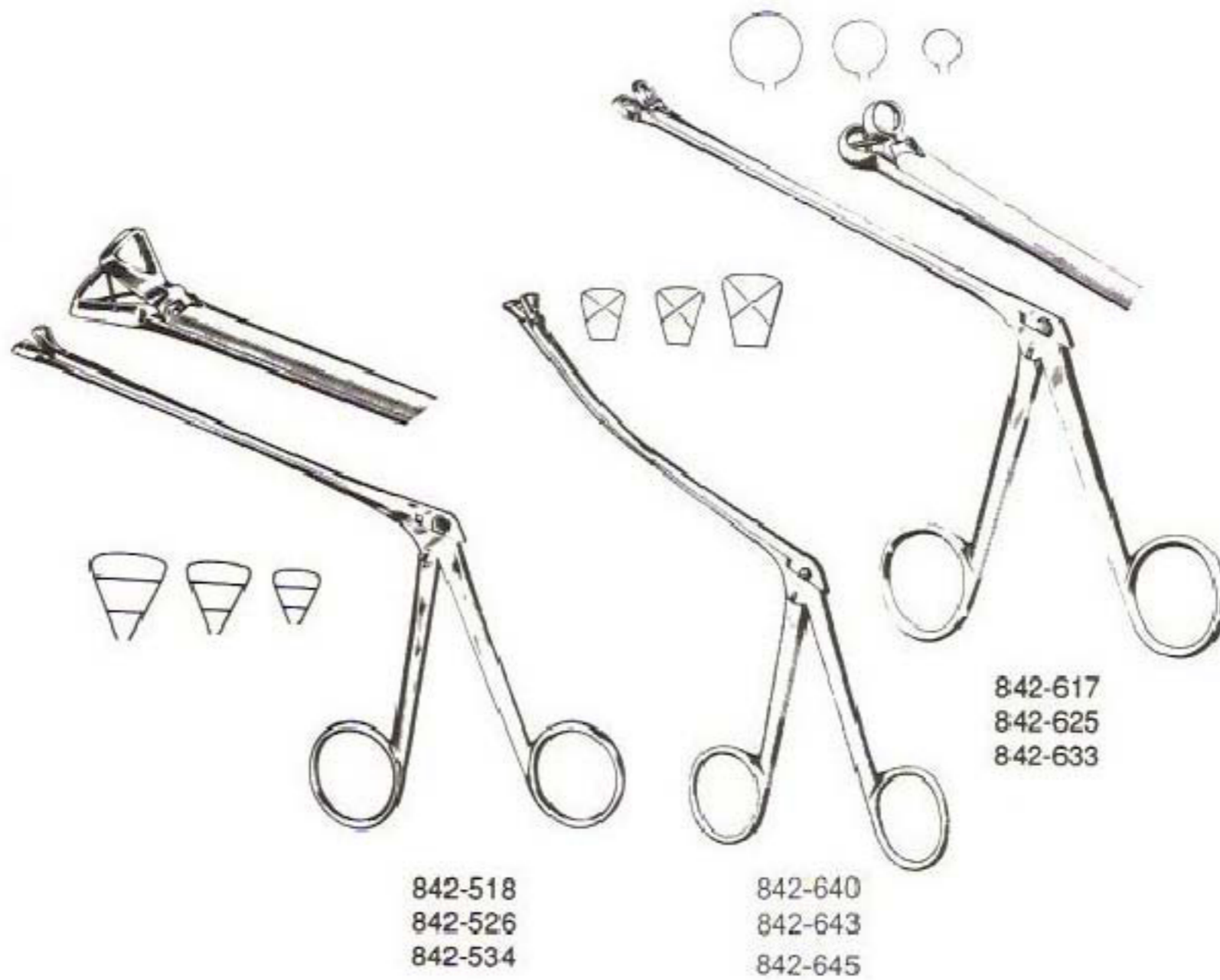

## TONSIL and ADENOID INSTRUMENTS

842-518	Schmeden (Meltzer) Tonsil Punch, Size 1, 6mm 5" shaft
842-526	Schmeden (Meltzer) Tonsil Punch, Size 2, 8mm 5" shaft
842-534	Schmeden (Meltzer) Tonsil Punch, Size 3, 10mm 5" shaft
842-617	Hartman Tonsil Punch, Size 1, 6mm 5-1/2" shaft
842-625	Hartman Tonsil Punch, Size 2, 8mm 5-1/2" shaft
842-633	Hartman Tonsil Punch, Size 3, 10mm 5-1/2" shaft
842-640	Ronis Punch, Triangular, Up-Curved, 5 1/2" (14cm) #1
842-643	Ronis Punch, Triangular, Up-Curved, 5 1/2" (14cm) #2
842-645	Ronis Punch, Triangular, Up-Curved, 5 1/2" (14cm) #3



## TONSIL and ADENOID INSTRUMENTS



- 842-708 Schnidt Tonsil Hemostat, 1 Open Ring, Slightly Curved, 7-1/2"  
842-716 Schnidt Tonsil Hemostat, 1 Open Ring, Straight, 7-1/2"
- 842-720 Schnidt Tonsil Hemostat, Closed Ring, Slightly Curved, 7-1/2"
- 842-757 Colver Tonsil Seizing Forceps, 1 Open Ring, Straight, 7-1/2"  
842-765 Colver Tonsil Seizing Forceps, 1 Open Ring, Curved, 7-1/2"
- 842-856 Whites Tonsil Seizing Forceps, 1 Open Ring, 7"  
842-864 Whites Tonsil Seizing Forceps, 1 Open Ring, 9"
- 842-906 Tydings Tonsil Seizing Forceps, 8", Angled 2 x 2 Prongs, Open Ring

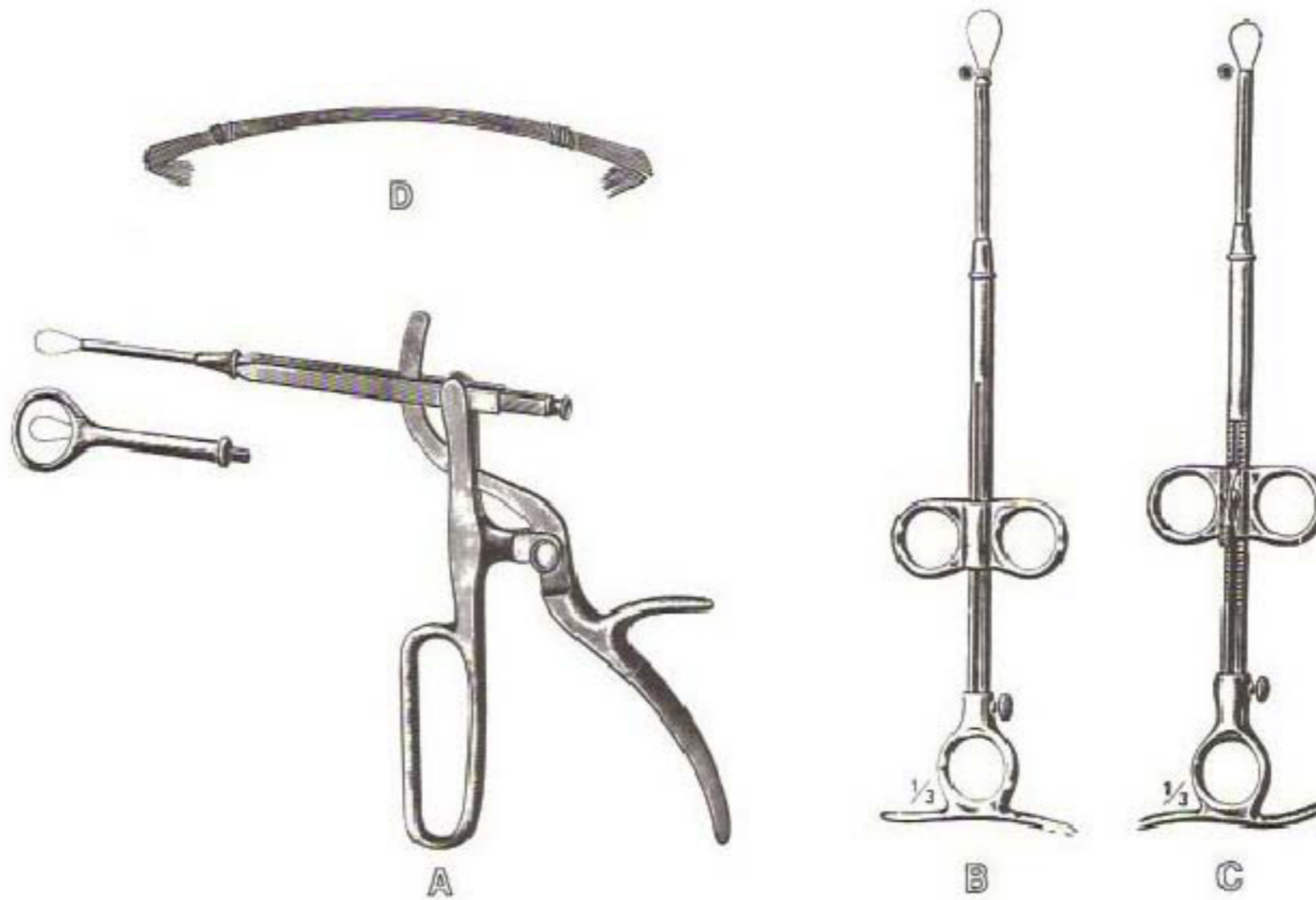

## TONSIL and ADENOID INSTRUMENTS

- A** 843-003 Tying Tonsil Snare, Complete with Straight Tip.
- B** 843-052 Eve, Tonsil Snare, Plain, Standard Model, 11"
- C** 843-102 Eve, Tonsil Snare, with Ratchet, 11"
  
- D** 843-177 Snare Wires, 4-1/2", Package of 12, #7
- 843-185 Snare Wires, 4-1/2", Package of 12, #8
- 843-193 Snare Wires, 4-1/2", Package of 12, #9
- 843-201 Snare Wires, 4-1/2", Package of 12 #10
- 843-276 Snare Wires, 4", Package of 12, #7
- 843-284 Snare Wires, 4", Package of 12, #8
- 843-292 Snare Wires, 4", Package of 12, #9
- 843-300 Snare Wires, 4", Package of 12, #10



## TONSIL and ADENOID INSTRUMENTS

- |   |         |  |
|---|---------|--|
| A | 844-001 | LaForce Adenotome, Infants, 8-1/2"                   |
|   | 844-019 | LaForce Adenotome, Small, 9-1/2"                     |
|   | 844-027 | LaForce Adenotome, Medium, 9-1/2"                    |
|   | 844-035 | LaForce Adenotome, Large, 9-1/2"                     |
|   | 844-258 | LaForce Adenotome Blade, Infant                      |
|   | 844-266 | LaForce Adenotome Blade, Small                       |
|   | 844-274 | LaForce Adenotome Blade, Medium                      |
|   | 844-282 | LaForce Adenotome Blade, Large                       |
| B | 844-381 | Love Uvula Retractor, Small, 18mm wide               |
|   | 844-407 | Love Uvula Retractor, Medium, 20mm wide              |
|   | 844-423 | Love Uvula Retractor, Large, 22mm wide               |
| C | 844-509 | Barnhill Adenoid Curette, 8-1/2", Size 0, 11mm Blade |
|   | 844-514 | Barnhill Adenoid Curette, 8-1/2", Size 1, 13mm Blade |
|   | 844-522 | Barnhill Adenoid Curette, 8-1/2", Size 2, 15mm Blade |
|   | 844-530 | Barnhill Adenoid Curette, 8-1/2", Size 3, 17mm Blade |
|   | 844-548 | Barnhill Adenoid Curette, 8-1/2", Size 4, 19mm Blade |



A

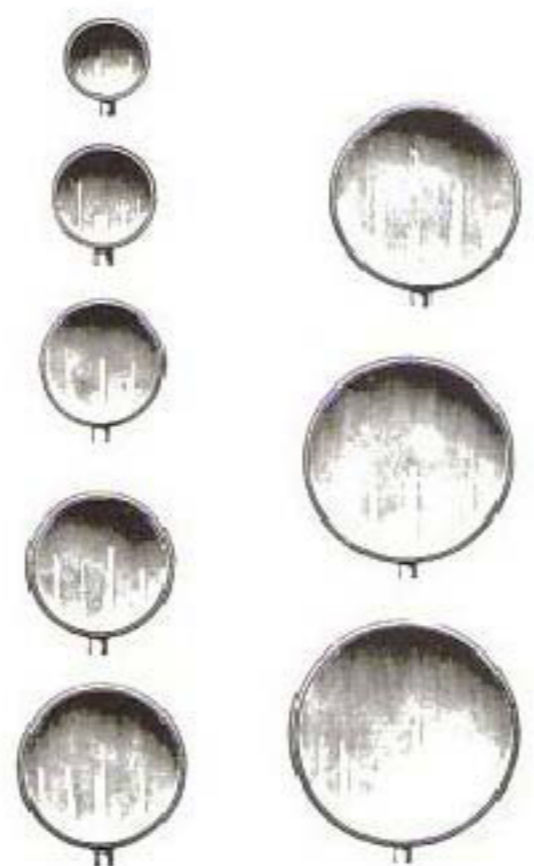

B

C

D

### TRACHEAL and LARYNGEAL INSTRUMENTS

- A 860-098 Laryngeal Mirror with Handle, #00
- 860-106 Laryngeal Mirror with Handle, #0
- 860-114 Laryngeal Mirror with Handle, #1
- 860-122 Laryngeal Mirror with Handle, #2
- 860-130 Laryngeal Mirror with Handle, #3
- 860-148 Laryngeal Mirror with Handle, #4
- 860-155 Laryngeal Mirror with Handle, #5
- 860-163 Laryngeal Mirror with Handle, #6

- B 860-551 Handle Only for Laryngeal Mirror with Chuck

- C 860-569 Handle Only for Laryngeal Mirror, Plain

- D 860-570 Handle Only, Hexagon with Set Screw

- E 861-096 Laryngeal Mirror without Handle, #00
- 861-104 Laryngeal Mirror without Handle, #0
- 861-112 Laryngeal Mirror without Handle, #1
- 861-120 Laryngeal Mirror without Handle, #2
- 861-138 Laryngeal Mirror without Handle, #3
- 861-146 Laryngeal Mirror without Handle, #4
- 861-153 Laryngeal Mirror without Handle, #5
- 861-161 Laryngeal Mirror without Handle, #6
- 861-162 Laryngeal Mirror without Handle, #7



E

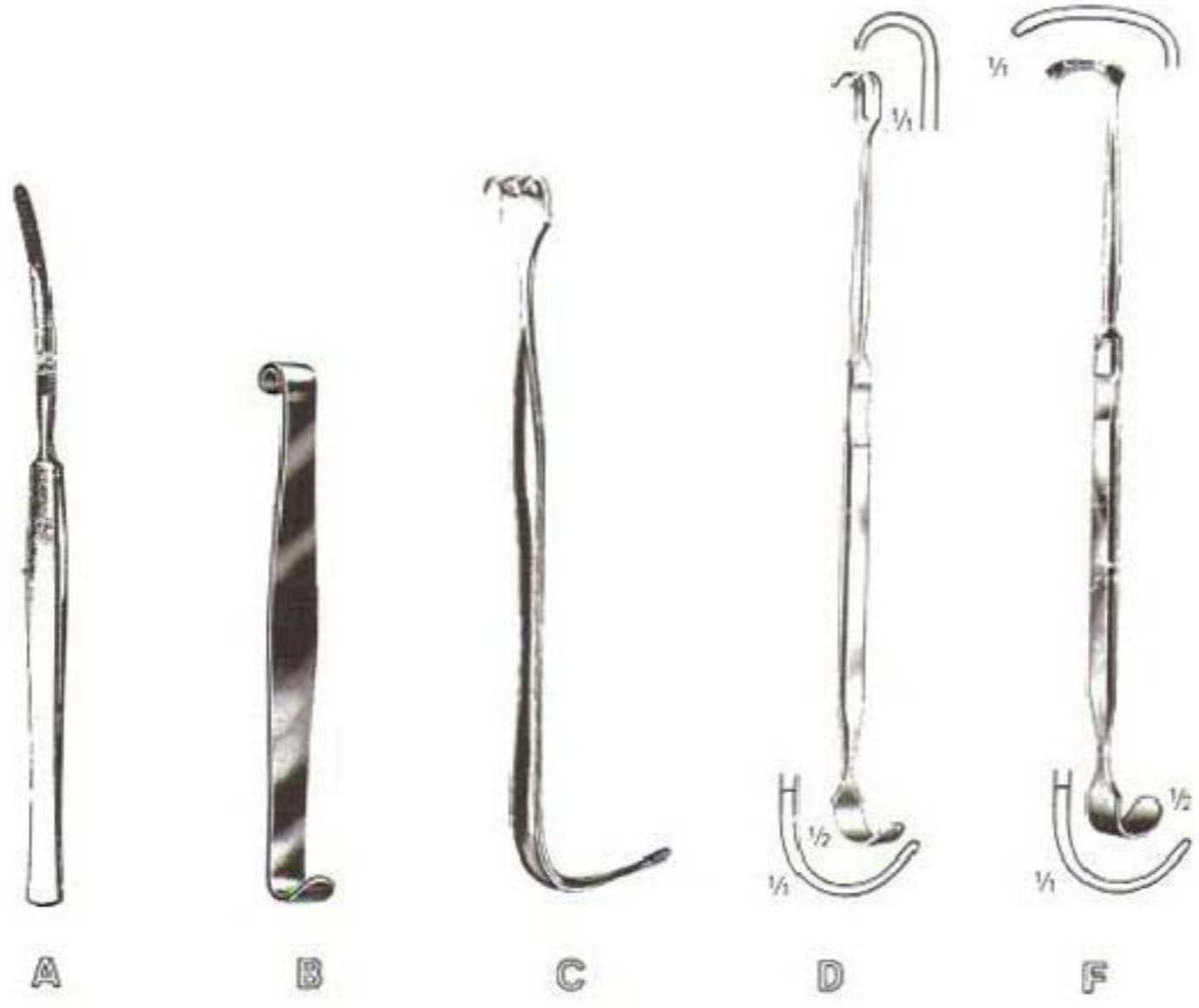

### TRACHEAL and LARYNGEAL INSTRUMENTS

- A 861-252 Jackson Tracheal Bistoury, 6-1/2"
- B 861-302 Luer Trachea Retractor, 4-1/2"
- C 861-351 Hupp Trachea Retractor, 5-1/4"
- D 861-401 Jackson Trachea Retractor, 6-3/4"
- E 861-450 Jackson Trachea Tenaculum, 5"
- F 861-500 Lukens Trachea Retractor, 6-3/4"
- G 861-559 Jackson Trachea Hemostat, Strong Curved, 5-1/2"





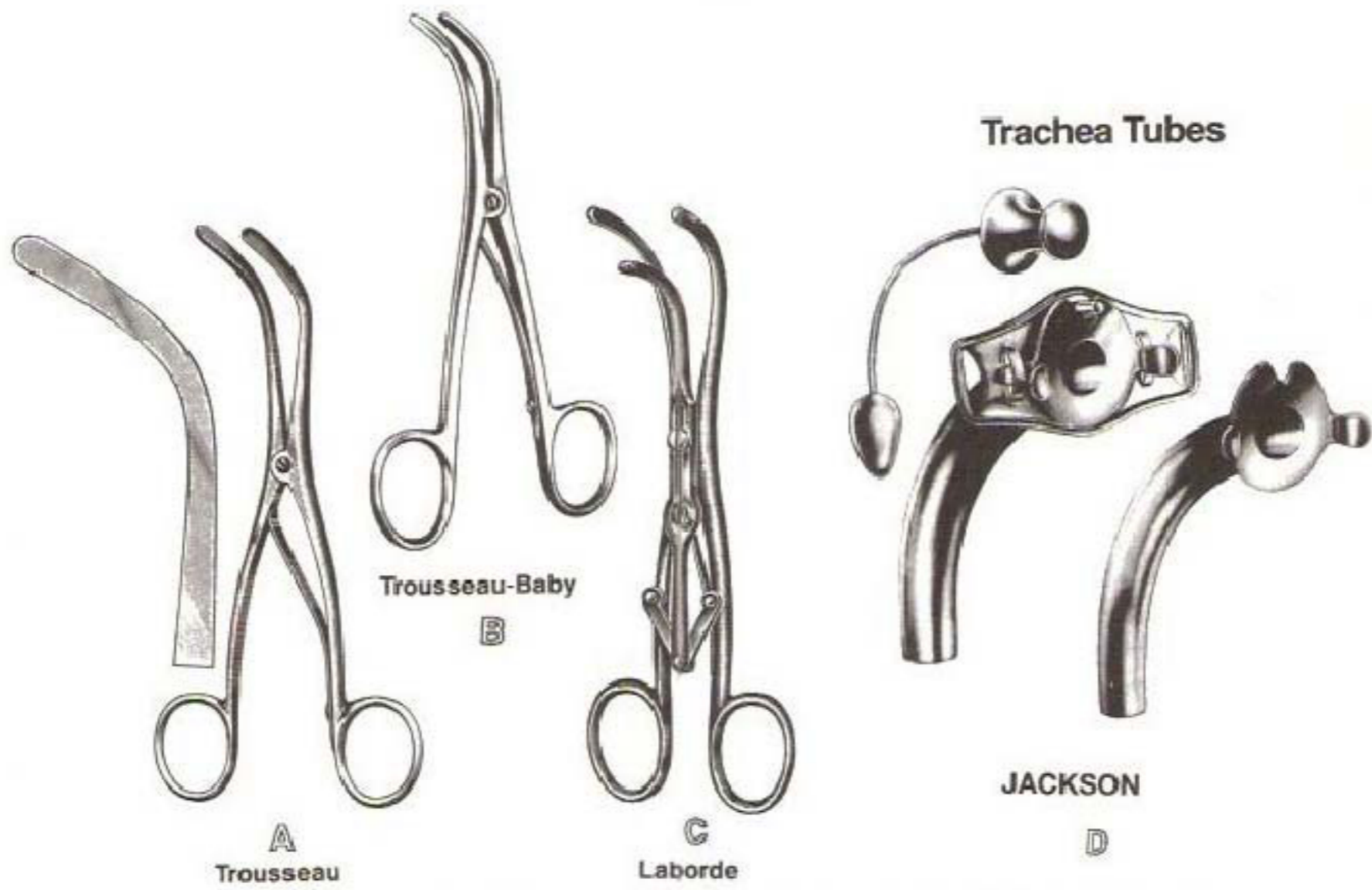

**TRACHEAL and LARYNGEAL INSTRUMENTS**

- A** 862-003 Trousseau Trachea Dilator, Child, 5-1/2"
- B** 862-001 Trousseau Trachea Dilator, Child, 4-1/2"
- C** 862-052 Laborde Trachea Dilator, 5-1/2"

**D Jackson Trachea Tube, Stainless**

- |         |  |         |   |
|---------|--|---------|---|
| 863-000 | Size, #00, (O.D. 4 mm), (4.4cm), 1-3/4"  | 863-068 | Size, #6, (O.D. 10 mm), (9cm), 3-1/2"     |
| 863-001 | Size, #0, (O.D. 5 mm), (5cm), 2"         | 863-076 | Size, #7, (O.D. 11 mm), (9.5cm), 3-3/4"   |
| 863-019 | Size, #1, (O.D. 5.5 mm), (5.7cm), 2-1/4" | 863-084 | Size, #8, (O.D. 12 mm), (10.2cm), 4"      |
| 863-027 | Size, #2, (O.D. 6 mm), (6.4cm), 2-1/2"   | 863-086 | Size, #9, (O.D. 13 mm), (10.5cm), 4-1/8"  |
| 863-035 | Size, #3, (O.D. 7 mm), (7cm), 2-3/4"     | 863-088 | Size, #10, (O.D. 14 mm), (10.5cm), 4-1/8" |
| 863-043 | Size, #4, (O.D. 8 mm), (7.5cm), 3"       | 863-090 | Size, #12, (O.D. 16 mm), (6.4cm), 2-1/2"  |
| 863-050 | Size, #5, (O.D. 9 mm), (8.5cm), 3-3/8"   |         |   |

**International Scale of Trachea Tube (Actual sizes)**

size	0	1	2	3	4	5	6	7	8	9
Ø mm	4	5	6	7	8	9	10	11	12	13
French	12	15	18	21	24	27	30	33	36	39
length mm	45	50	55	60	65	70	75	80	85	90

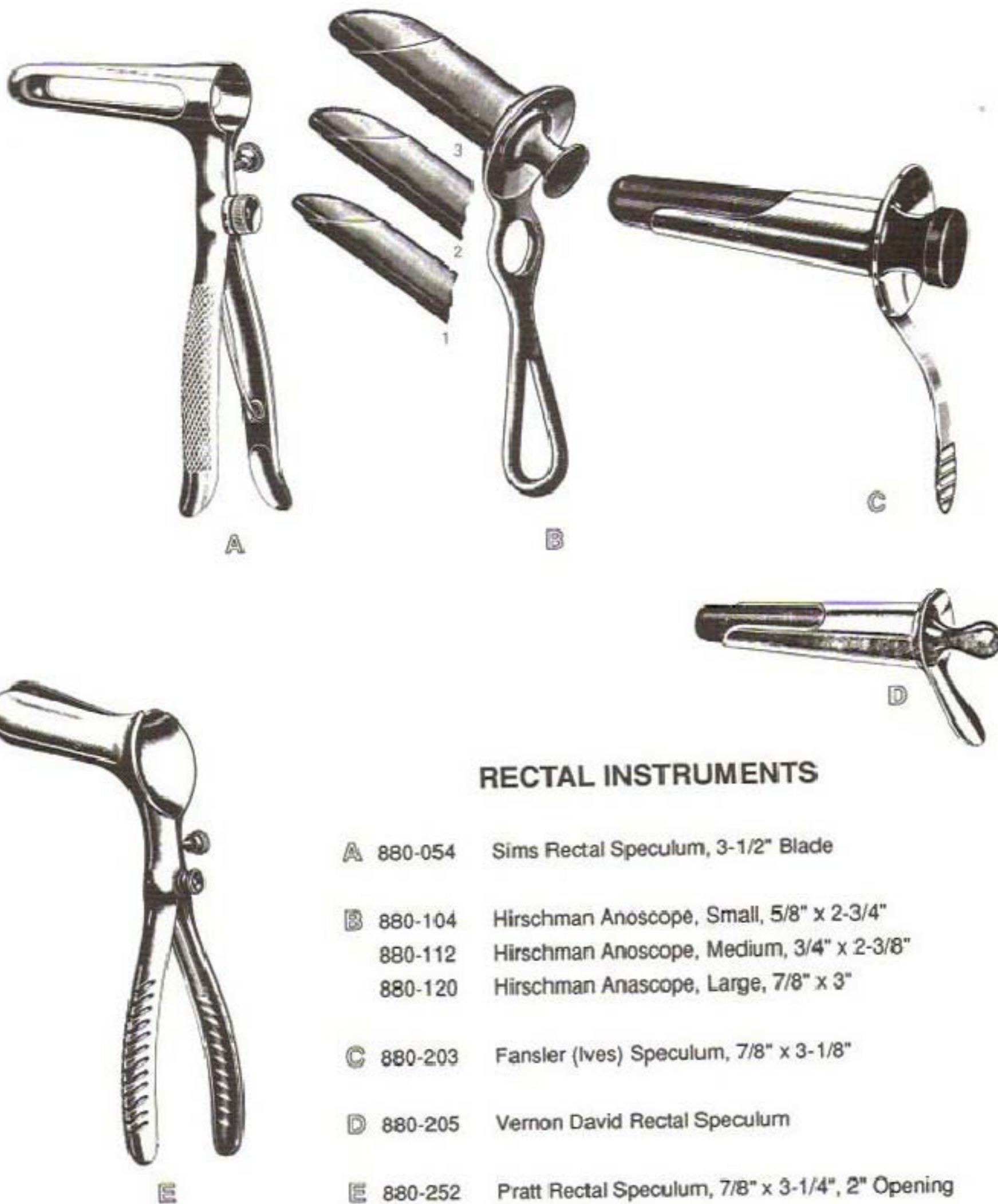

## RECTAL INSTRUMENTS

- A 880-054 Sims Rectal Speculum, 3-1/2" Blade
- B 880-104 Hirschman Anoscope, Small, 5/8" x 2-3/4"  
880-112 Hirschman Anoscope, Medium, 3/4" x 2-3/8"  
880-120 Hirschman Anoscope, Large, 7/8" x 3"
- C 880-203 Fansler (Ives) Speculum, 7/8" x 3-1/8"
- D 880-205 Vernon David Rectal Speculum
- E 880-252 Pratt Rectal Speculum, 7/8" x 3-1/4", 2" Opening



## RECTAL INSTRUMENTS

- |   |         |  |
|---|---------|--|
| A | 880-302 | Brinckerhoff Rectal Speculum, Small, 3-1/2" x 7/8"   |
|   | 880-310 | Brinckerhoff Rectal Speculum, Medium, 4-1/2" x 1"    |
|   | 880-328 | Brinckerhoff Rectal Speculum, Large, 4-1/2" x 1-1/8" |
| B | 880-385 | Smith Anal Retractor, 7/8" x 2-3/4"                  |
| C | 880-500 | Sawyer Rectal Retractor, Small, 2-1/2" x 7/8", 10"   |
|   | 880-518 | Sawyer Rectal Retractor, Medium, 3" x 1-1/8", 10"    |
|   | 880-526 | Sawyer Rectal Retractor, Large, 3-1/2" x 1-1/2"      |



880-658



880-807



880-757



880-906



880-910  
880-912



### RECTAL INSTRUMENTS

- 880-658 LARRY Probe and Grooved Director, 7" (17.8 cm)
- 880-757 ROSSER Crypt Hook, 6-3/4" (17.1 cm)
- 880-807 BARR Double Ended Probe, 7" (17.8 cm), rigid
- 880-906 BARR Crypt Hook, 10" (25.4 cm), short and long hook ends
- 880-910 STEWART Crypt Hook, 8-1/2" (21.6 cm), short style
- 880-912 STEWART Crypt Hook, 8-1/2" (21.6 cm), long style
- 880-920 Rectal Cotton Carrier, 15" (38.1 cm) shaft, with spring action



## RECTAL INSTRUMENTS



Latex O-rings  
Bag of 100



- |   |         |   |
|---|---------|---|
| A | 881-003 | Buie Pile Clamp, Curved, Angiotribe Jaws, 8 1/2"  |
| B | 881-250 | Douglas Rectal Snare (Norwood), 12" Working Length  |
| C | 881-252 | Weston Rectal Snare, Angled, 12"  |
| D | 882-200 | McGivney Hemorrhoidal Ligator, Complete with Loading Cone and 100 "O" Rings, 6" working length  |
|   | 882-205 | McGivney Hemorrhoidal Ligator, Complete with Loading Cone and 100 "O" Rings, 7" working length  |
|   | 882-210 | McGivney Hemorrhoidal Ligator, Complete with Loading Cone and 100 "O" Rings, 8" working length  |
|   | 882-215 | McGivney Hemorrhoidal Ligator, Complete with Loading Cone and 100 "O" Rings, 10" working length |
|   | 882-218 | "O" Rings for Ligator, Package of 100   |
|   | 882-220 | Loading Cone Only for McGivney Ligator  |
| E | 882-222 | McGivney Hemorrhoidal Grasping Forceps, Angled Shanks 7-1/2"                                    |

Weston

C

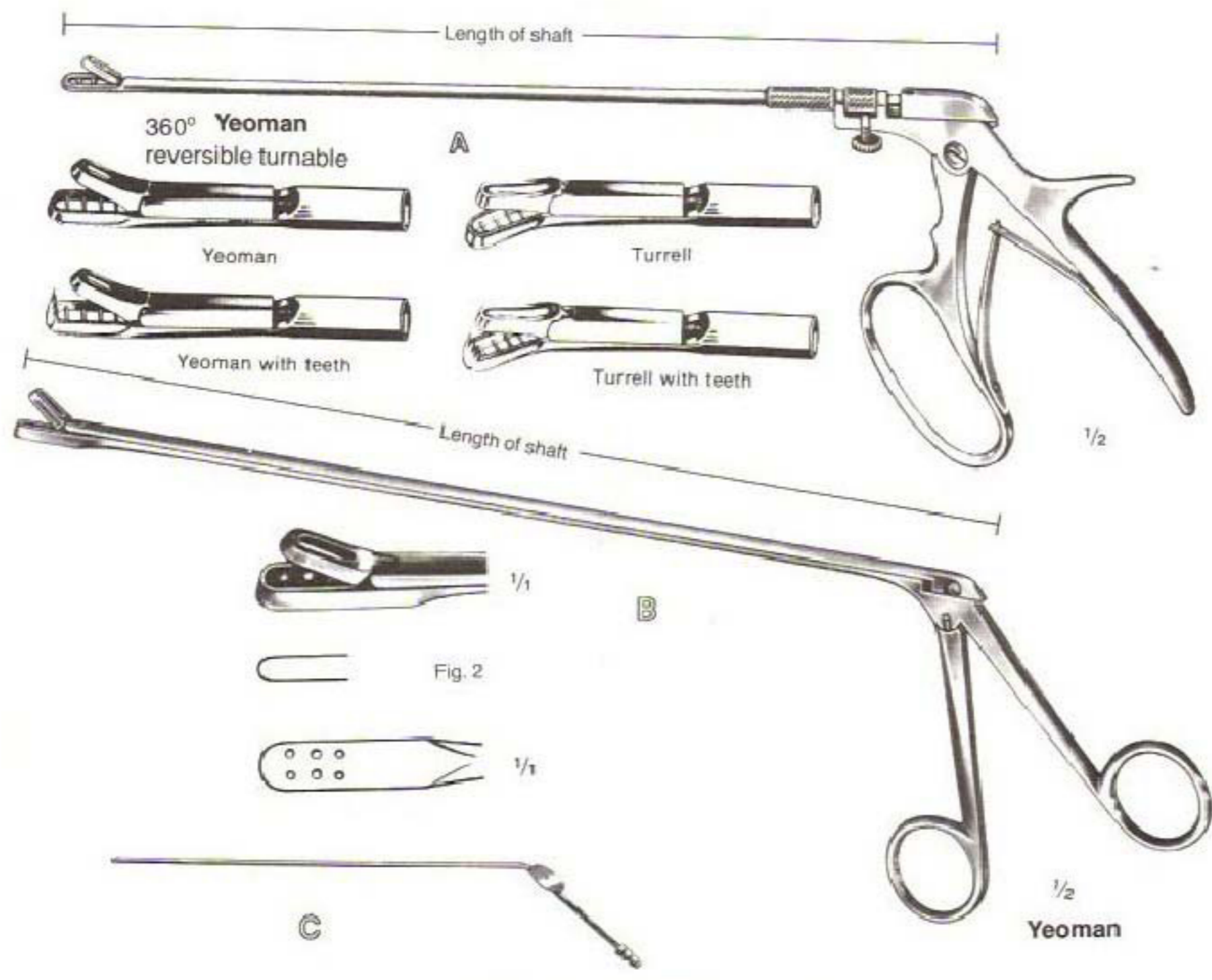

### RECTAL INSTRUMENTS

**A** YEOMAN BIOPSY FORCEPS with ROTATING SHAFTS,  
Straight 4 X 8 mm Bite, With Basket

Complete with Ring Handle	Shaft Length	Shaft Only
881-507	10" (25.4 cm)	881-511
881-508	14" (35.6 cm)	881-512
881-509	14" (35.6 cm)	881-513 w/teeth
881-510	16" (40.6 cm)	881-514

**B** TURRELL BIOPSY FORCEPS with ROTATING SHAFTS,  
Angled Jaws 4 X 8 mm Bite, with basket

Complete with Ring Handle	Shaft Length	Shaft Only
881-515	10" (25.4 cm)	881-519
881-516	14" (35.6 cm)	881-521 w/teeth
881-517	14" (35.6 cm)	881-520
881-518	16" (40.6 cm)	881-522

- B** 881-607 YEOMAN Biopsy Forceps, 9" (22.9 cm) shaft, 3.5 X 10 mm bite, with basket
- 881-615 YEOMAN Biopsy Forceps, 13" (33 cm) shaft, 3.5 X 10 mm bite, with basket
- 881-623 YEOMAN Biopsy Forceps, 15" (38.1 cm) shaft, 3.5 X 10 mm bite, with basket

- C** 881-706 BUIE Suction Tube, 18" (45 cm), with finger valve, 15 Fr. (5 mm)

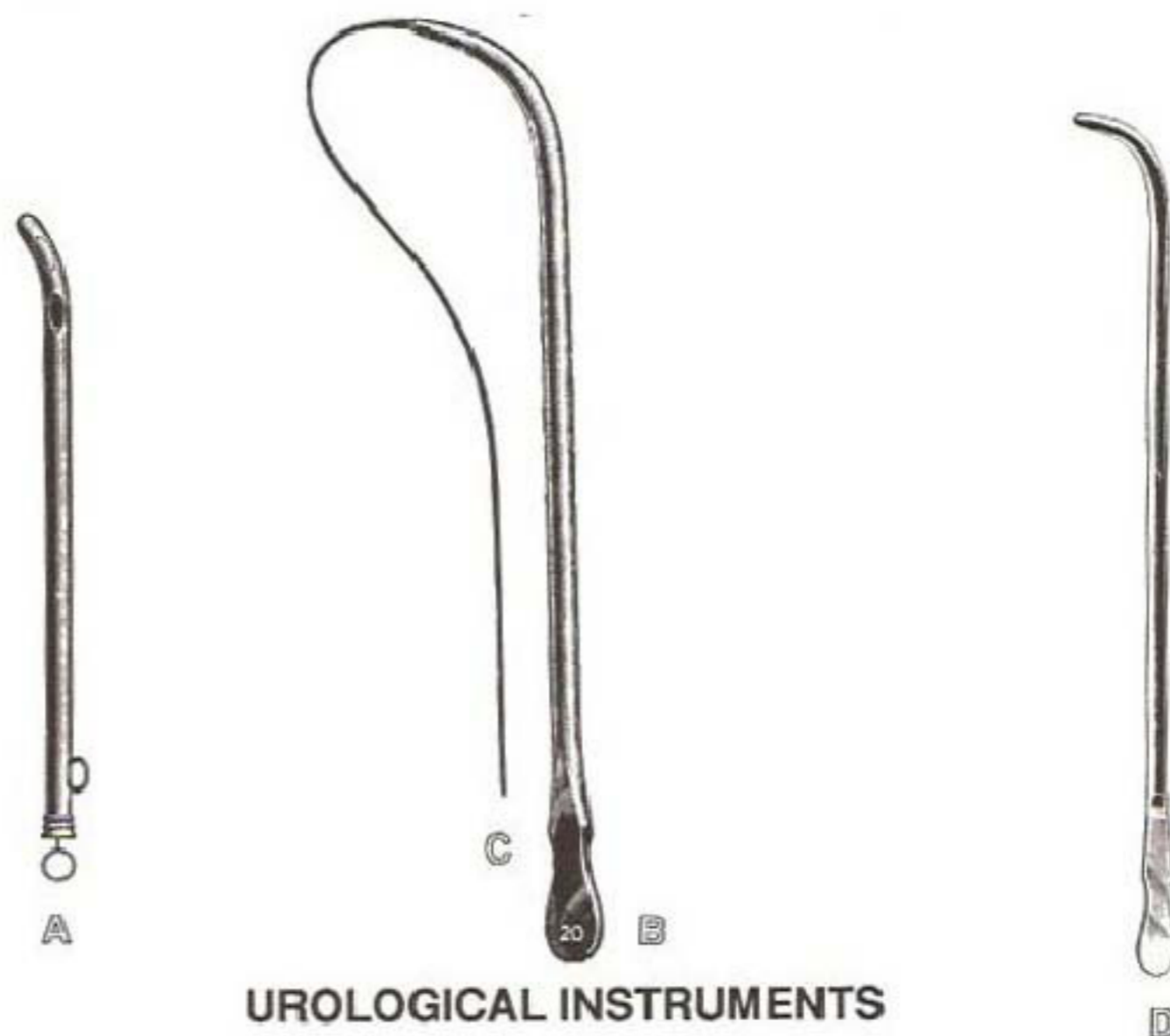

**UROLOGICAL INSTRUMENTS**

- |  |   |  |  |
|--|---|--|--|
| <p><b>A</b> 900-126 Female Catheter, Plain, 12 fr.<br/>         900-142 Female Catheter, Plain, 14 fr.<br/>         900-167 Female Catheter, Plain, 16 fr.<br/>         900-183 Female Catheter, Plain, 18 fr.<br/>         900-209 Female Catheter, Plain, 20 fr.</p> | <p><b>B</b> 900-324 LeFort Sound, 12 fr., 11"<br/>         900-340 LeFort Sound, 14 fr., 11"<br/>         900-365 LeFort Sound 16 fr., 11"<br/>         900-381 LeFort Sound, 18 fr., 11"<br/>         900-407 LeFort Sound, 20 fr., 11"<br/>         900-423 LeFort Sound, 22 fr., 11"<br/>         900-449 LeFort Sound, 24 fr., 11"<br/>         900-464 LeFort Sound, 26 fr., 11"</p> | <p><b>C</b> 900-514 Filiform Guide for LeFort Sound, Size 1<br/>         900-522 Filiform Guide for LeFort Sound, Size 2<br/>         900-530 Filiform Guide for LeFort Sound, Size 3<br/>         900-548 Filiform Guide for LeFort Sound, Size 4<br/>         900-555 Filiform Guide for LeFort Sound, Size 5<br/>         900-563 Filiform Guide for LeFort Sound, Size 6</p> | <p><b>D</b> 901-082 Van Buren Sound, 8 Fr., 11"<br/>         901-108 Van Buren Sound, 10 Fr., 11"<br/>         901-124 Van Buren Sound, 12 Fr., 11"<br/>         901-140 Van Buren Sound, 14 Fr., 11"<br/>         901-165 Van Buren Sound, 16 Fr., 11"<br/>         901-181 Van Buren Sound, 18 Fr., 11"<br/>         901-207 Van Buren Sound, 20 Fr., 11"<br/>         901-223 Van Buren Sound, 22 Fr., 11"<br/>         901-249 Van Buren Sound, 24 Fr., 11"<br/>         901-264 Van Buren Sound, 26 Fr., 11"<br/>         901-280 Van Buren Sound, 28 Fr., 11"<br/>         901-306 Van Buren Sound, 30 Fr., 11"<br/>         901-322 Van Buren Sound, 32 Fr., 11"<br/>         901-348 Van Buren Sound, 34 Fr., 11"<br/>         901-362 Van Buren Sound, 36 Fr., 11"<br/><br/>         901-405 Van Buren Sound, Set of 6, 18-28 Fr.<br/>         901-454 Van Buren Sound, Set of 8, 16-30 Fr.<br/>         901-504 Van Buren Sound, Set of 12, 8-30 Fr.</p> |
|--|---|--|--|

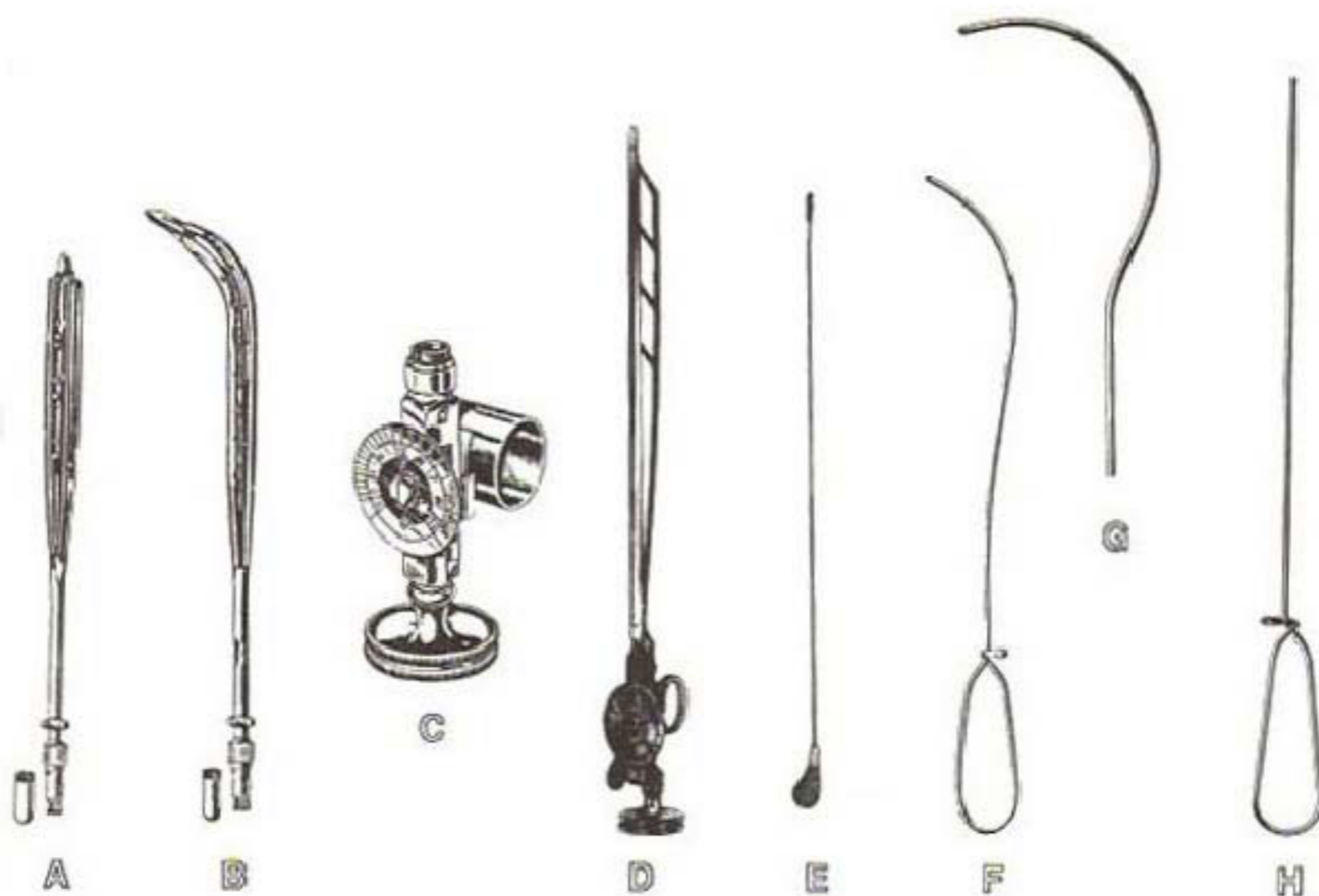

## UROLOGICAL INSTRUMENTS

### KOLLMAN Urethral Dilators

- A 902-254 Kollman Urethral Dilator, Straight
- B 902-304 Kollman Urethral Dilator, Van Buren Curve
- C 902-353 Kollman Dilator, Handle Only

- D 902-502 OTIS Urethrotome, in case

- E 902-510 Blade Only for Urethrotome

### CATHETER Guides

- F 902-601 Catheter Guide, Guyon Curve 17"
- G 902-619 Catheter Guide, Van Buren Curve 14-1/8"
- H 902-627 Catheter Guide, Straight 15-3/4"



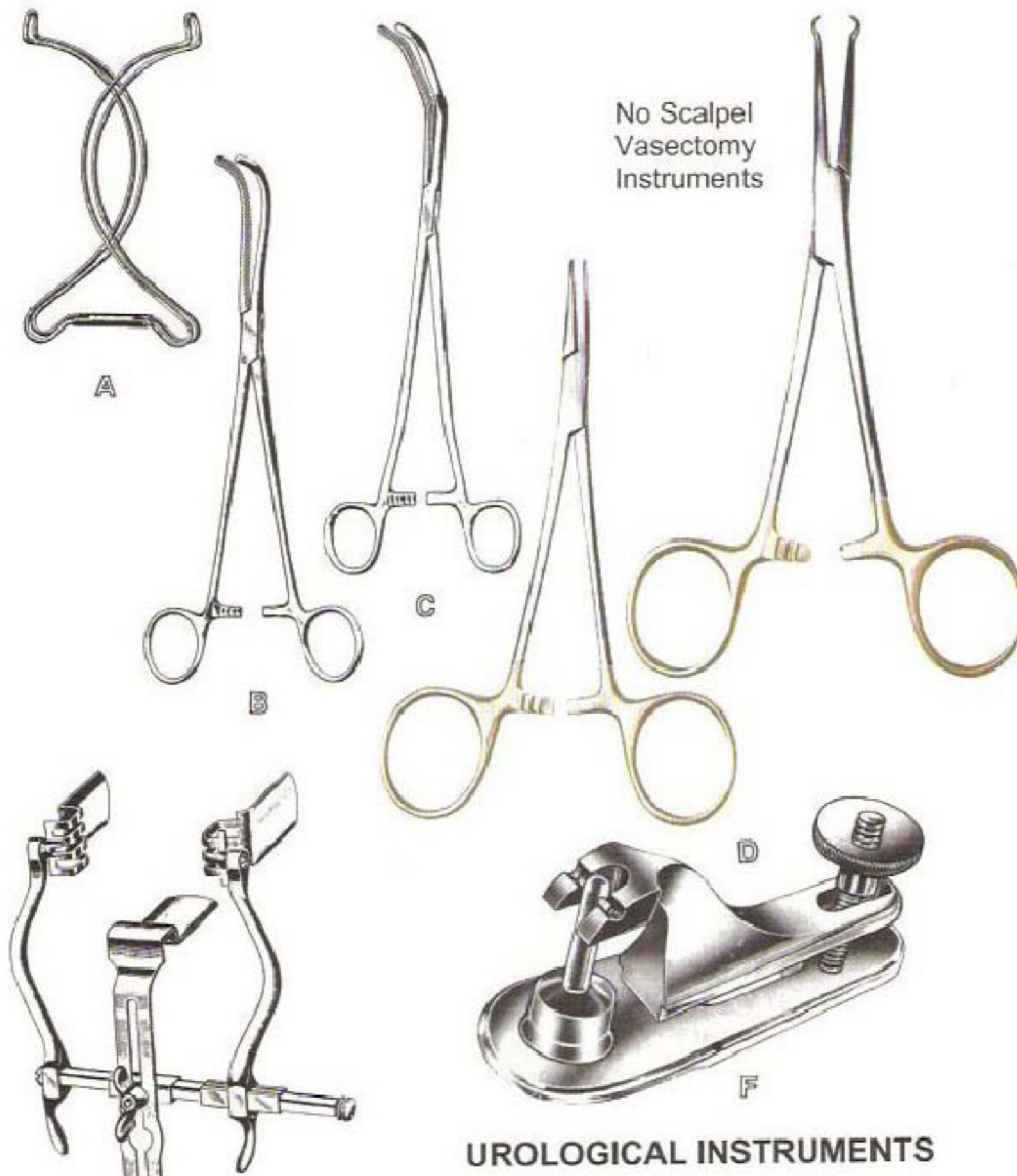

No Scalpel  
Vasectomy  
Instruments

## UROLOGICAL INSTRUMENTS

- |          |         |  |
|----------|---------|--|
| <b>A</b> | 902-700 | Zipser Penis Clamp   |
| <b>B</b> | 902-759 | Guyon-Pean Kidney Clamp, Double Curved, 9 1/2"   |
| <b>C</b> | 902-809 | Herricks Kidney Clamp, 9"  |
| <b>D</b> | 903-010 | No-Scalpel Vasectomy Ring Clamp, 5 1/2" (14 cm), Gold Finger Rings                           |
|          | 903-012 | No-Scalpel Vasectomy Hemostat, 5 1/2" (14 cm), Smooth sharp Point, Curved, Gold Finger Rings |
| <b>E</b> | 903-005 | Masson-Judd Suprapubic Retractor with Center Blade   |
| <b>F</b> | 903-014 | Gomco Circumcision Clamp, Stainless, 8mm, (1.1cm)  |
|          | 903-016 | Gomco Circumcision Clamp, Stainless, 11mm (1.3cm)  |
|          | 903-018 | Gomco Circumcision Clamp, Stainless, 13mm (1.45cm)   |
|          | 903-020 | Gomco Circumcision Clamp, Stainless, 16mm (1.6cm)  |



## UROLOGICAL INSTRUMENTS



903-104



903-112



903-120



930-138



903-146



903-148

- |         |   |
|---------|---|
| 882-225 | Lowsley Prostractic Retractor, Straight, 11" (Not Illustrated)                                    |
| 882-230 | Lowsley Prostractic Retractor, Curved, 11" (Not Illustrated)                                      |
| 882-235 | Lowsley Prostractic Retractor, Straight, 13" (Not Illustrated)                                    |
| 882-240 | Lowsley Prostractic Retractor, Curved, 13" (Not Illustrated)                                      |
| 882-245 | McDougal Type Prostatectomy Forceps, 2cm Jaw w/cross serrations, 10-1/2", Left (Not Illustrated)  |
| 882-250 | McDougal Type Prostatectomy Forceps, 2cm Jaw w/cross serrations, 10-1/2", Right (Not Illustrated) |
| 882-255 | McDougal Type Prostatectomy Forceps, 2.5cm Right Angle, 11", Left (Not Illustrated)               |
| 882-260 | McDougal Type Prostatectomy Forceps, 2.5cm Right Angle, 11", Right (Not Illustrated)              |
| 882-265 | Kalman-Mixter Forceps, Right Angle Jaws, Light Pattern, 11" (Not Illustrated)                     |
| 882-270 | Kalman-Mixter Forceps, Right Angle Jaws, Heavy Pattern, 11" (Not Illustrated)                     |
| 903-104 | YOUNG Prostratic Retractor, Anterior, 1-1/2" x 2-1/2", 8-3/4" (22.2 cm)                           |
| 903-112 | YOUNG Prostratic Retractor, Bifid, 1-1/2" x 2-1/2", 8-3/4" (22.2 cm)                              |
| 903-120 | YOUNG Prostratic Retractor, Notched, 8-3/4" (22.2 cm)   |
| 903-138 | YOUNG Prostratic Retractor, Lateral, 7/16" x 2-1/2", 8-3/4" (22.2 cm)                             |
| 903-146 | YOUNG Prostratic Retractor, improved, 8-3/4" (22.2 cm)  |
| 903-148 | YOUNG Prostratic Tractor, 1-1/2" x 2-1/2", 8" (20.3 cm)   |

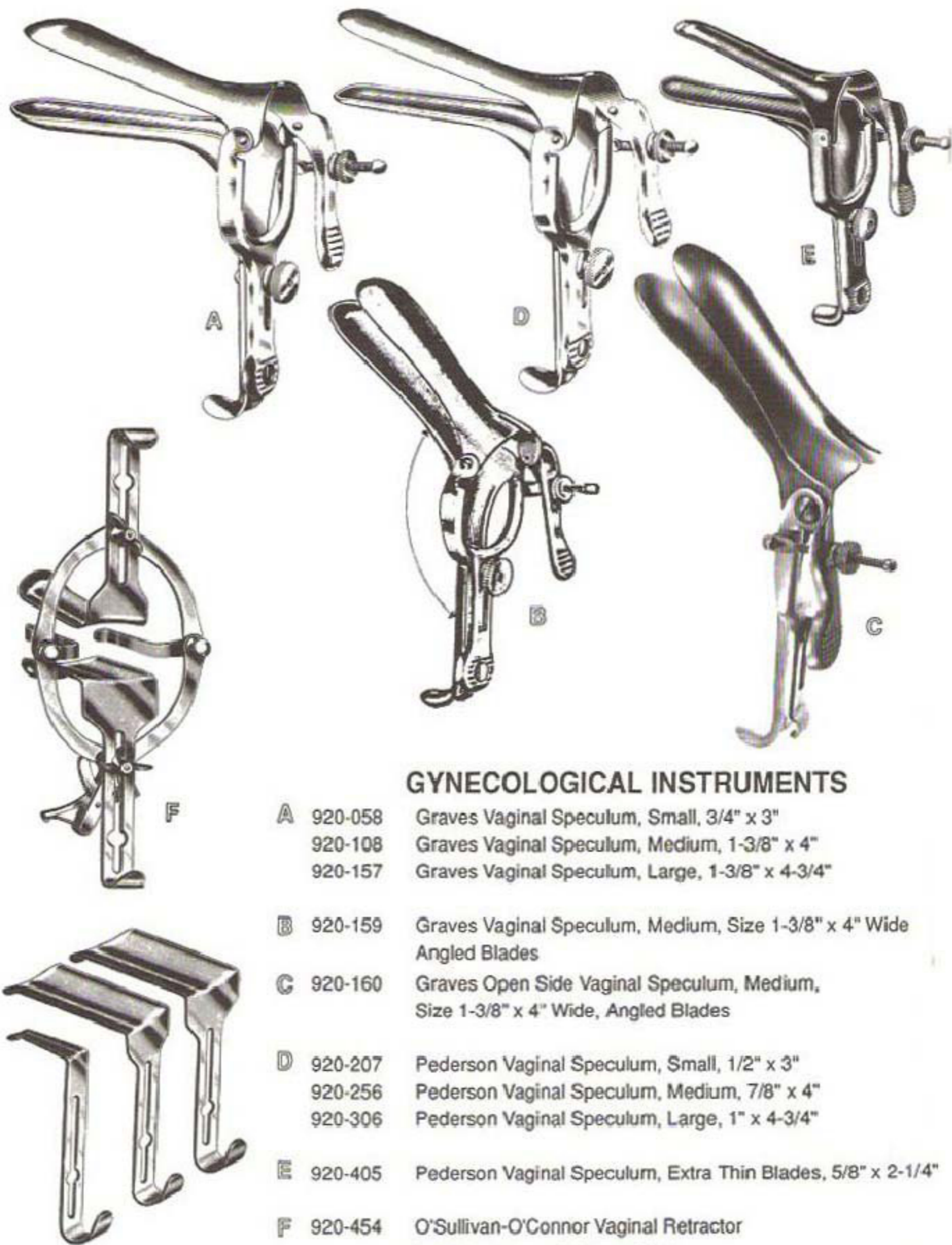

## GYNECOLOGICAL INSTRUMENTS

- A** 920-058 Graves Vaginal Speculum, Small, 3/4" x 3"  
 920-108 Graves Vaginal Speculum, Medium, 1-3/8" x 4"  
 920-157 Graves Vaginal Speculum, Large, 1-3/8" x 4-3/4"
- B** 920-159 Graves Vaginal Speculum, Medium, Size 1-3/8" x 4" Wide Angled Blades
- C** 920-160 Graves Open Side Vaginal Speculum, Medium, Size 1-3/8" x 4" Wide, Angled Blades
- D** 920-207 Pederson Vaginal Speculum, Small, 1/2" x 3"  
 920-256 Pederson Vaginal Speculum, Medium, 7/8" x 4"  
 920-306 Pederson Vaginal Speculum, Large, 1" x 4-3/4"
- E** 920-405 Pederson Vaginal Speculum, Extra Thin Blades, 5/8" x 2-1/4"
- F** 920-454 O'Sullivan-O'Connor Vaginal Retractor Self-Retaining with Three Blades



## GYNECOLOGICAL INSTRUMENTS

- 920-410 COLLIN Vaginal Speculum for Children, 55 X 10mm  
 920-412 COLLIN Vaginal Speculum, 65 x 20mm for Virgins  
 920-414 COLLIN Vaginal Speculum, 90 x 16mm for Virgins
- 920-416 COLLIN Vaginal Speculum, small, 1 1/4" (3.2 cm) X 3 3/4" (9.5 cm)  
 920-418 COLLIN Vaginal Speculum, medium, 1 3/8" (3.5 cm) X 4" (10.2 cm)  
 920-420 COLLIN Vaginal Speculum, large, 1 5/8" (4.1cm) X 4 1/2" (11.4 cm)
- 920-422 DeVILBISS Vaginal Speculum, small size, 3-1/2" (8.9 cm) X 7/8" (2.2 cm) blades  
 920-424 DeVILBISS Vaginal Speculum, medium size, 4" (10.2 cm) X 1-1/4" (3.2 cm) blades  
 920-426 DeVILBISS Vaginal Speculum, large size, 5" (12.7 cm) X 1-3/8" (3.5 cm) blades
- 920-428 WEISMAN-GRAVES Vaginal Speculum,  
 Left-Lateral Opening, 1-1/4 x 4-1/2" Blades  
 920-430 WEISMAN-GRAVES Vaginal Speculum,  
 Right-Lateral Opening, 1-1/4 x 4-1/2" Blades



## GYNECOLOGICAL INSTRUMENTS

- 920-432 CUSCO Vaginal Speculum, Virgins with Center Screw, 3/4" (1.9 cm) X 3 1/4" (8.3 cm)
- 920-434 CUSCO Vaginal Speculum, small, with center screw, 1 1/4" (3.2 cm) X 3 1/2" (8.9 cm)
- 920-436 CUSCO Vaginal Speculum, medium, with center screw, 1 3/8" (3.5 cm) X 4" (10.2 cm)
- 920-438 CUSCO Vaginal Speculum, large, with center screw, 1 3/8" (3.5 cm) X 4" (10.2 cm)
- 920-440 CUSCO Vaginal Speculum, Virgins with side screw, 3/4" (1.9 cm) X 3 1/4" (8.3 cm)
- 920-442 CUSCO Vaginal Speculum, small, with side screw, 1 1/4" (3.2 cm) X 3 1/2" (8.9 cm)
- 920-444 CUSCO Vaginal Speculum, medium, with side screw, 1 3/8" (3.5 cm) X 4" (10.2 cm)
- 920-446 CUSCO Vaginal Speculum, large, with side screw, 1 3/8" (3.5 cm) X 4" (10.2 cm)
- 920-448 GUTMANN Vaginal Speculum, examining type, self-retaining, 1-3/8" (3.5 cm) X 4" (10.2 cm)
- 920-450 MOORE-GRAVES Vaginal Speculum, 1-1/4" x 3"

The Lateral Vaginal Retractor improves access and viewing of the cervix during a procedure.

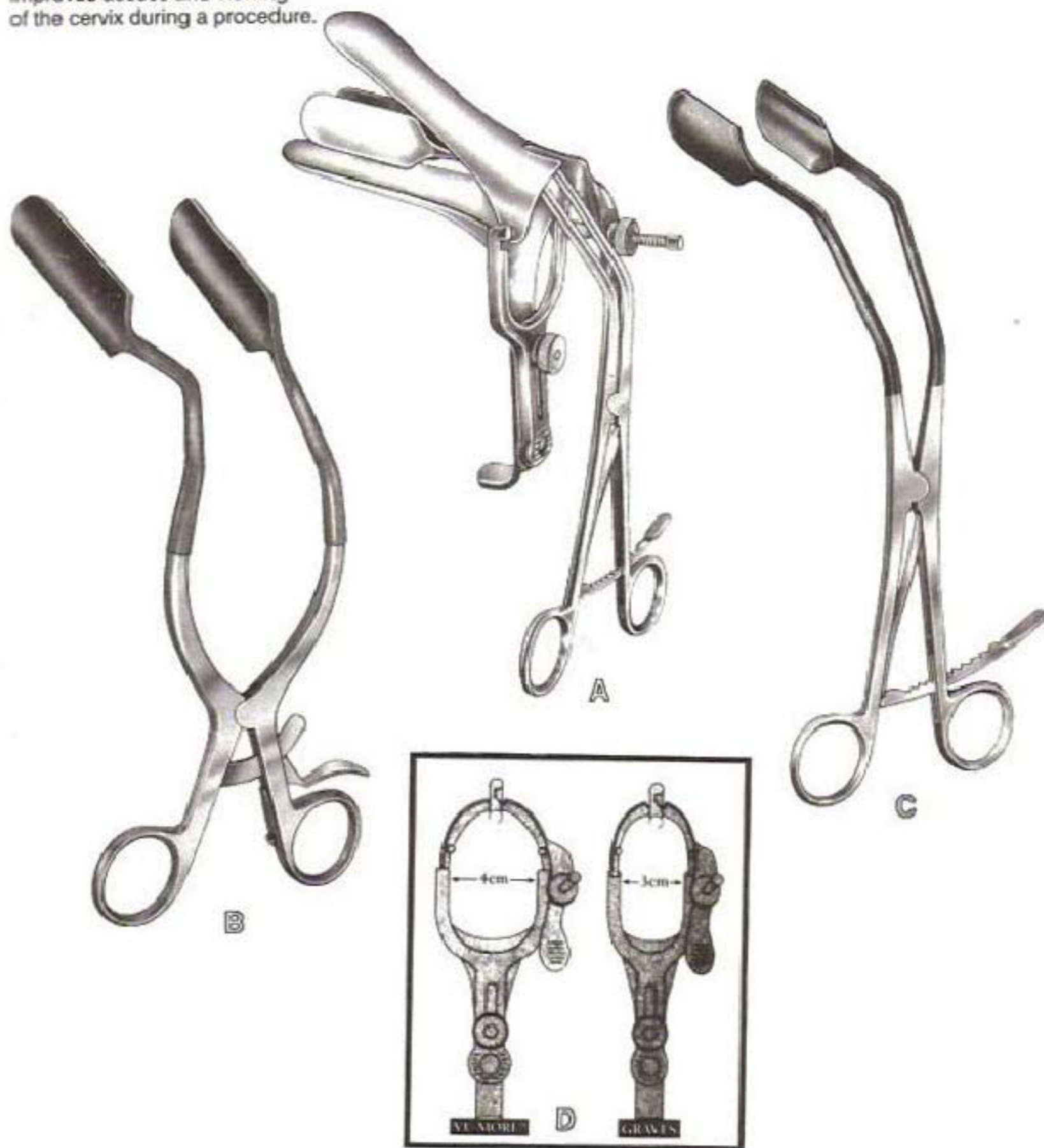

## GYNECOLOGICAL INSTRUMENTS

- A** 920-456 LEEP lateral Vaginal Retractor, 2-1/2" x 1", Working Length 4-1/2", with Gold Plated Ratchet Handles, 10-1/2"
- B** 920-457 LEEP Lateral Wall Retractor (open shanks), 2-1/2" x 1", Working Length 4-1/2", with Gold Plated Ratchet Handles, Non-Conductive
- C** 920-458 LEEP Lateral Wall Retractor (closed shanks), 2-1/2" x 1", Working Length 4-1/2", with Gold Plated Ratchet Handles, Non-Conductive
- D** 920-459 View-More Vaginal Specula, Medium  
920-460 View-More Vaginal Specula, Large

Insulated for Laser- and Electrosurgery

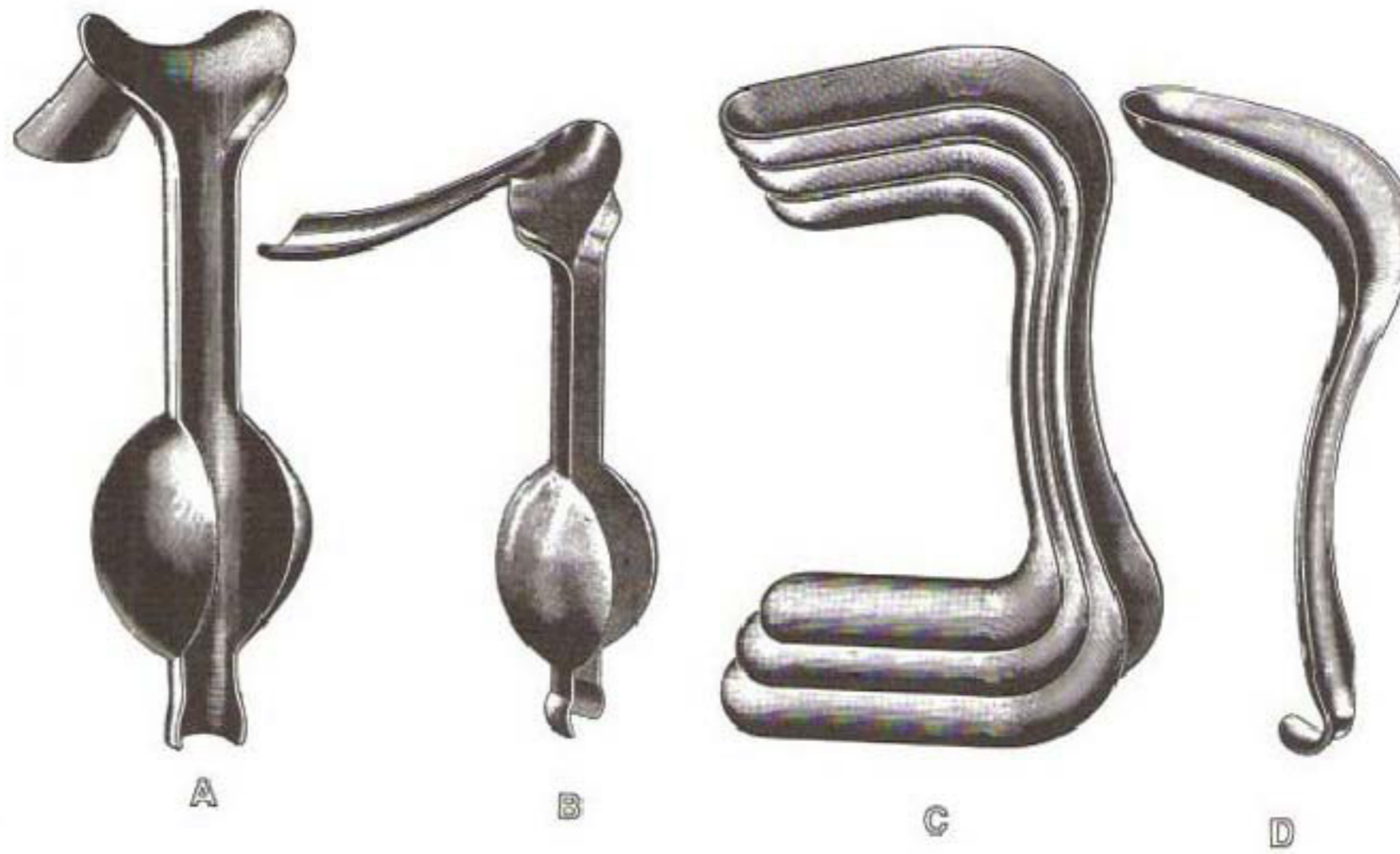

## GYNECOLOGICAL INSTRUMENTS

A	920-601	AUVARD Weighted Vaginal Speculum, 9" (22.9 cm), Straight Blade 1-1/2"x 3-1/4", 2 lbs. (909 g), slightly angled 75 degrees
	920-603	AUVARD Weighted Vaginal Speculum, 9" (22.9 cm), straight Blade 1-1/2" x 3-1/4", 2.5 lbs. (1136 g), slightly angled 75 degrees
	920-605	AUVARD Weighted Vaginal Speculum, 9" (22.9 cm), Straight Blade 1-1/2" x 3-1/4", 3 lbs. (1363 g), slightly angled 75 degrees
B	920-607	AUVARD Weighted Vaginal Speculum, 9" (22.9 cm), 2.5 lbs. (1136 g), blade at acute angle (45 degrees)
C	920-652	STEINER-AUVARD Weighted Vaginal Speculum, 2.5 lbs., (1136 g), slightly curved blades, 5-1/2" x 1-1/4" at 90 degree angle
	920-702	SIMS Vaginal Speculum, double end, small size, 1" x 2-1/2" and 1-1/4" x 3-1/2"
	920-710	SIMS Vaginal Speculum, double end, medium size, 1-1/8" x 3" and 1-1/4" x 3-1/2"
D	920-728	SIMS Vaginal Speculum, double end, large size, 1-3/8" x 3-1/2" and 1-1/2" x 4"
	920-736	SIMS Vaginal Speculum, single end, small size, 1-1/16" (2.7 cm) X 2-1/2" (6.4 cm)
	920-744	SIMS Vaginal Speculum, single end, medium size, 1-1/4" (3.2 cm) X 3" (7.6 cm)
	920-751	SIMS Vaginal Speculum single end, large size, 1-1/2" (3.8 cm) X 3-1/2" (8.9 cm)



## GYNECOLOGICAL INSTRUMENTS



- |          |         |   |
|----------|---------|---|
| <b>A</b> | 920-801 | Sims Vaginal Retractor, Improved, Small, 1-1/6" x 2-1/2", 9-3/4"  |
|          | 920-819 | Sims Vaginal Retractor, Improved, Medium, 1-1/4" x 3-1/2", 9-3/4" |
|          | 920-827 | Sims Vaginal Retractor, Improved, Large, 1-11/6" x 4", 9-3/4"     |
| <b>B</b> | 920-900 | Eastman Vaginal Retractor, Small, 1-1/2" x 3", 7"                 |
|          | 920-918 | Eastman Vaginal Retractor, Medium, 1-1/2" x 3-1/2", 7"            |
|          | 920-926 | Eastman Vaginal Retractor, Large, 1-1/2" x 4", 7"                 |
| <b>C</b> | 921-007 | Jackson Vaginal Retractor, Small, 1-1/2" x 3", 7"                 |
|          | 921-015 | Jackson Vaginal Retractor, Medium, 1-1/2" x 3-1/2", 7"            |
|          | 921-003 | Jackson Vaginal Retractor, Large, 1-1/2" x 4", 7"                 |
| <b>D</b> | 921-304 | Heaney Simon Vaginal Retractor, 1" x 4-1/2", 10-1/4"              |
| <b>E</b> | 921-502 | Heaney Vaginal Retractor, Small, 1" x 1-3/4", 10-1/2"             |
|          | 921-510 | Heaney Vaginal Retractor, Medium, 1-1/8" x 2-7/8", 10-1/2"        |
|          | 921-528 | Heaney Vaginal Retractor, Large, 1-1/8" x 3-1/4", 10-1/2"         |





## GYNECOLOGICAL INSTRUMENTS

- |   |         |   |
|---|---------|---|
| A | 921-700 | Bozeman Uterine Dressing Forceps, Straight, 10"             |
| B | 921-718 | Bozeman Uterine Dressing Forceps, Curved, 10"               |
| C | 921-726 | Bozeman Uterine Dressing Forceps, Curved, 1 Large Ring, 10" |
| D | 922-054 | Sims Uterine Sound, Graduated in Centimeters, 11-1/2"       |
| E | 922-062 | Sims Uterine Sound, Plain (Probe), 11-1/2"                  |
| F | 922-104 | Simpson Uterine Sound, Graduated in Inches, 11-1/2"         |
|   | 922-112 | Simpson Uterine Sound, Graduated in Centimeters, 11-1/2"    |
| G | 922-302 | Goodell Uterine Dilator, 11"                                |
|   | 922-310 | Goodell Uterine Dilator, 13"                                |





## GYNECOLOGICAL INSTRUMENTS

- |          |         |  |
|----------|---------|--|
| <b>A</b> | 922-500 | Hegar Uterine Dilators, Set of 8, 3/4mm to 17/18mm |
| <b>B</b> | 922-518 | Hegar Uterine Dilator, 1/2mm                       |
|          | 922-526 | Hegar Uterine Dilator, 3/4mm                       |
|          | 922-534 | Hegar Uterine Dilator, 5/8mm                       |
|          | 922-542 | Hegar Uterine Dilator, 7/8mm                       |
|          | 922-559 | Hegar Uterine Dilator, 9/10mm                      |
|          | 922-567 | Hegar Uterine Dilator, 11/12mm                     |
|          | 922-575 | Hegar Uterine Dilator, 13/14mm                     |
|          | 922-583 | Hegar Uterine Dilator, 15/16mm                     |
|          | 922-591 | Hegar Uterine Dilator, 17/18mm                     |
|          | 922-609 | Hegar Uterine Dilator, 19/20mm                     |
|          | 922-617 | Hegar Uterine Dilator, 21/22mm                     |
|          | 922-623 | Hegar Uterine Dilator, 23/24mm                     |
|          | 922-625 | Hegar Uterine Dilator, 25/26mm                     |



A

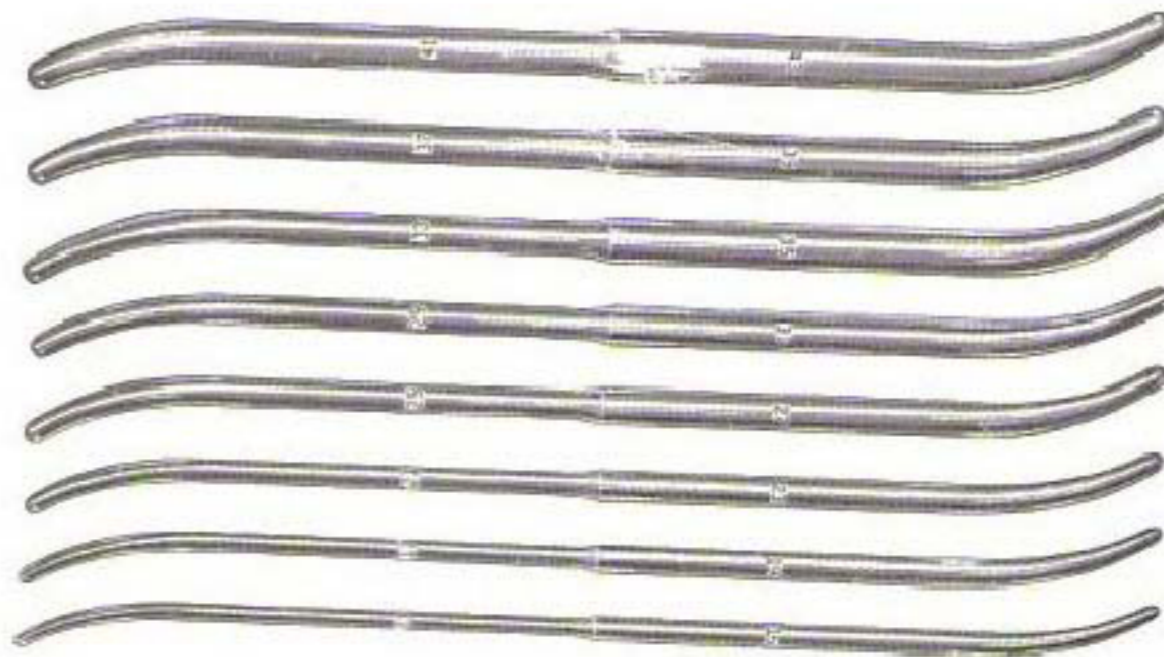

B

## GYNECOLOGICAL INSTRUMENTS

- A**
- |         |  |
|---------|--|
| 922-708 | Hank Uterine Dilators, Set of 6, 9/10 Fr to 19/20 Fr<br>Double End, 11", in Khaki roll, American Scale |
| 922-710 | Hank Uterine Dilator, 7/8 Fr   |
| 922-716 | Hank Uterine Dilator, 8/10 Fr  |
| 922-724 | Hank Uterine Dilator, 11/12 Fr   |
| 922-732 | Hank Uterine Dilator, 13/14 Fr   |
| 922-740 | Hank Uterine Dilator, 15/16 Fr   |
| 922-757 | Hank Uterine Dilator, 17/18 Fr   |
| 922-765 | Hank Uterine Dilator, 19/20 Fr   |
| 922-773 | Hank Uterine Dilator, 21/22 Fr   |
| 922-781 | Hank Uterine Dilator, 23/24 Fr   |
| 922-799 | Hank Uterine Dilator, 25/26 Fr   |
| 922-807 | Hank Uterine Dilator, 27/28 Fr   |
| 922-815 | Hank Uterine Dilator, 29/30 Fr   |

- B**
- |         |  |
|---------|--|
| 922-850 | Pratt Uterine Dilators, Set of 8 13/15 Fr to 41/43 Fr<br>Double End, 11 1/2" in Khaki Roll |
| 922-855 | Pratt Uterine Dilator, 13/15 Fr  |
| 922-857 | Pratt Uterine Dilator, 17/19 Fr  |
| 922-859 | Pratt Uterine Dilator, 21/23 Fr  |
| 922-861 | Pratt Uterine Dilator, 25/27 Fr  |
| 922-863 | Pratt Uterine Dilator, 29/31 Fr  |
| 922-865 | Pratt Uterine Dilator 33/35 Fr   |
| 922-867 | Pratt Uterine Dilator 37/39 Fr   |
| 922-869 | Pratt Uterine Dilator 41/43 Fr   |

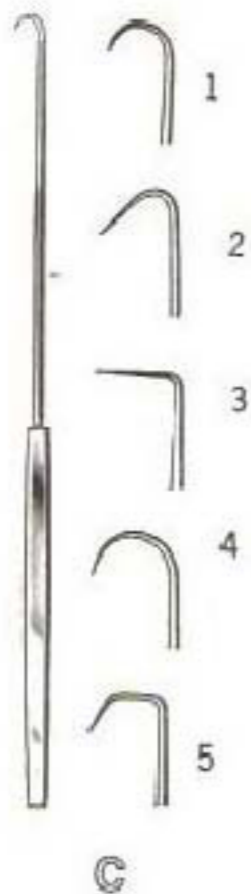

C

- C**
- |         |   |
|---------|---|
| 923-011 | Emmett Uterine Tenaculum Hook, Style #1, 9" |
| 923-029 | Emmett Uterine Tenaculum Hook, Style #2, 9" |
| 923-037 | Emmett Uterine Tenaculum Hook, Style #3, 9" |
| 923-045 | Emmett Uterine Tenaculum Hook, Style #4, 9" |
| 923-046 | Emmett Uterine Tenaculum Hook, Style #5, 9" |



923-102

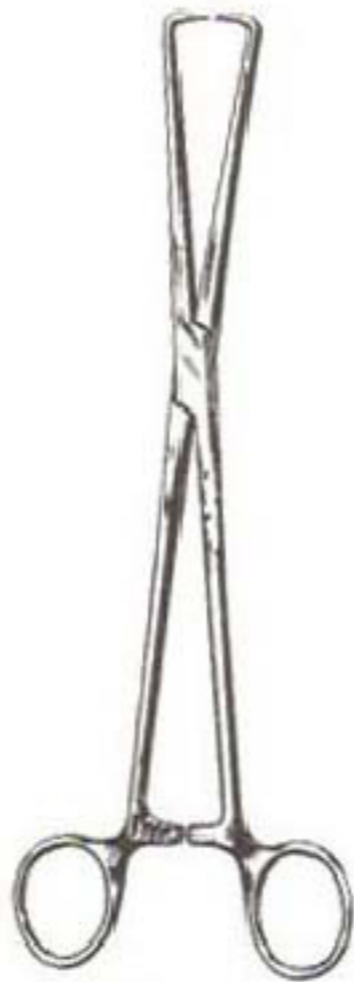

923-151



912-169



923-201



923-250

## GYNECOLOGICAL INSTRUMENTS

- 923-102 Barrett Uterine Tenaculum Forceps, 7"
- 923-151 Braun Uterine Tenaculum Forceps, Straight, 9"
- 923-169 Braun Uterine Tenaculum Forceps, Angled To Side, 9"
- 923-201 Duplay Tenaculum Forceps, Double Curved, 9"
- 923-250 Jarcho Tenaculum Forceps, Double Curved, 7-1/2"



923-300



923-359



923-409



923-458



923-508



923-302

## GYNECOLOGICAL INSTRUMENTS

- 923-300 SCHROEDER Uterine Tenaculum Forceps, 9-3/4" (24.8 cm), straight
- 923-302 SCHROEDER Uterine Tenaculum Forceps, Coated, 10" (24.8 cm), straight
- 923-359 SKENE Uterine Tenaculum Forceps, 9-1/2" (24.1 cm), curved on side
- 923-409 STAUDE-MOORE Tenaculum Forceps, 5-1/2" (14.0 cm), Straight
- 923-458 FERGUSON Tenaculum Forceps, 6-3/4" (17.1 cm), straight jaws
- 923-508 ADAIR Uterine Tenaculum Forceps, 6-1/2" (16.5 cm)



923-557  
923-565  
923-573



923-689

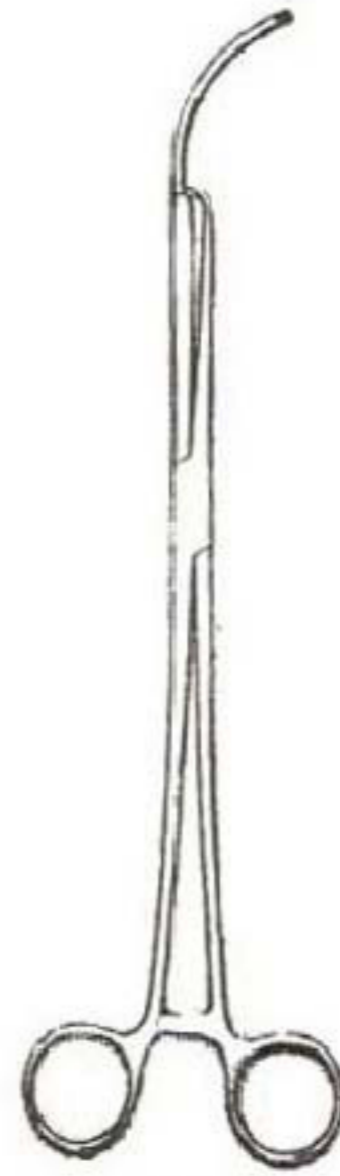

923-774

## GYNECOLOGICAL INSTRUMENTS

- |         |  |
|---------|--|
| 923-557 | Schroeder Vulsellum Forceps, Straight, 9-1/2"        |
| 923-565 | Schroeder Vulsellum Forceps, Curved, 9-1/2"          |
| 923-573 | Schroeder Vulsellum Forceps, Curved Sideways, 9-1/2" |
| 923-689 | Collin Buxton Uterine Clamp, 10-1/2", Swivel Jaws    |
| 923-774 | Hulka Controlling Tenaculum and Uterine Sound, 11"   |



## GYNECOLOGICAL INSTRUMENTS

- |          |         |   |
|----------|---------|---|
| <b>A</b> | 923-805 | JACOBS Uterine Vulsellum Forceps, 8-1/2" (21.6 cm), straight, serrated jaws, 2 X 2 teeth                        |
|          | 923-813 | JACOBS Uterine Vulsellum Forceps, 8-1/2" (21.6 cm), serrated jaws, curved sideways, 2 X 2 teeth                 |
| <b>B</b> | 923-854 | HENROTIN Vulsellum Forceps, 9-1/4" (23.5 cm)  |
| <b>C</b> | 923-918 | TEALE Vulsellum Forceps, 10" (25.4 cm), curved sideways, 3 X 4 teeth, 5 mm wide                                 |
| <b>D</b> | 924-001 | NOVAK Endocervical Suction Biopsy Curette, 9-3/4" (24.8 cm), with luer hub, 2 mm diameter, extra delicate       |
|          | 924-002 | NOVAK Endocervical Suction Biopsy Curette, 9-3/4" (24.8 cm), with luer hub, 3 mm diameter, delicate             |
|          | 924-003 | NOVAK Endocervical Suction Biopsy Curette, 9-3/4" (24.8 cm), with luer hub, 4 mm diameter, standard 12 Fr. size |
| <b>E</b> | 924-050 | RANDALL Endocervical Suction Biopsy Curette, 9-3/4" (24.8 cm), with luer hub, 4 mm diameter                     |

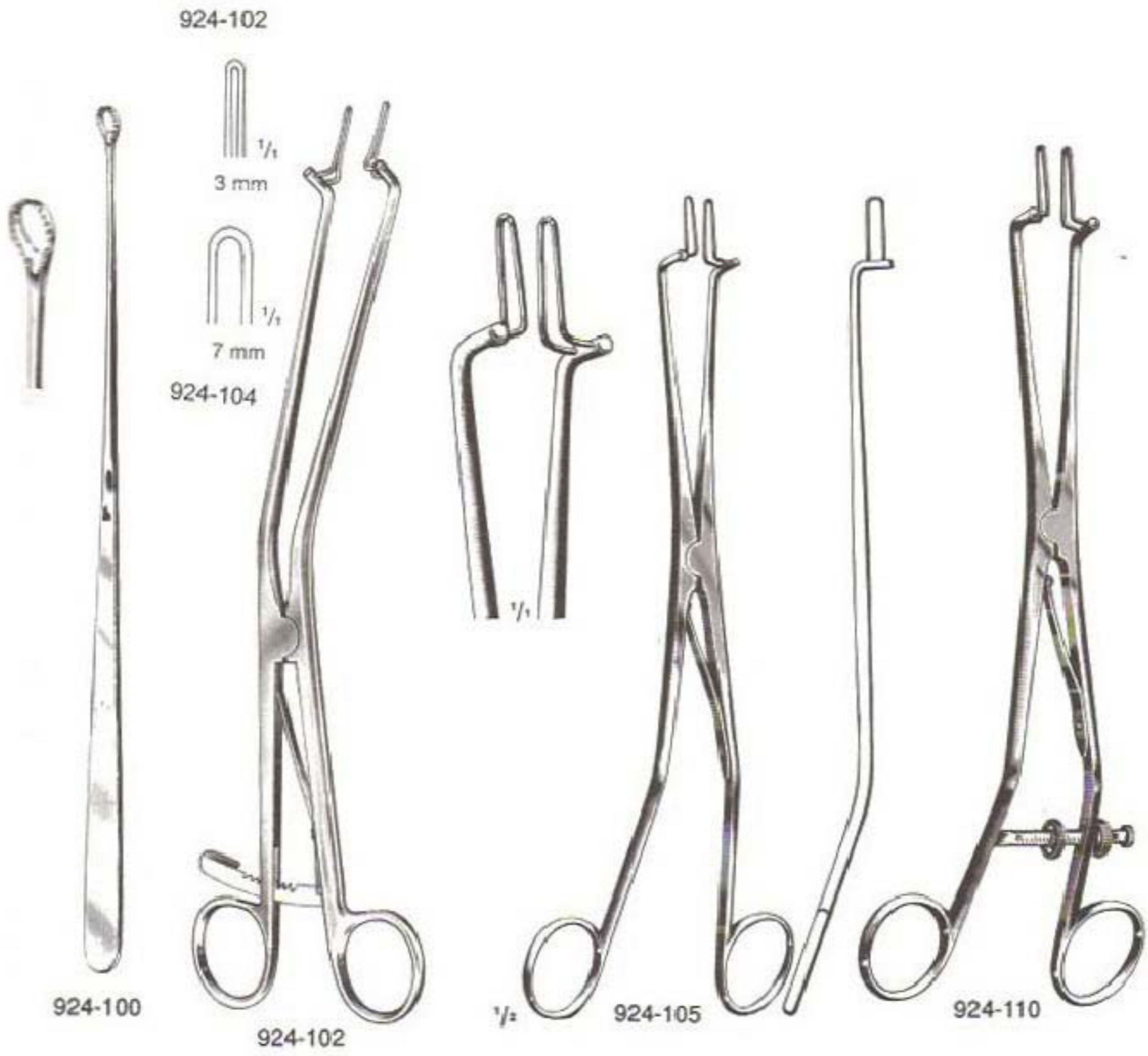

**GYNECOLOGICAL INSTRUMENTS**

- 924-100 HEANEY Uterine Biopsy Curette, 9" (22.9 cm), serrated loop
- 924-102 KOGAN Endocervical Speculum, 11" (27.9 cm), improved pattern with ratchet, delicate fenestrated jaws 3 mm wide at tip X 25 mm long, Gold Plated Handles
- 924-104 KOGAN Endocervical Speculum, 11" (27.9 cm), improved pattern with ratchet, delicate fenestrated jaws 7 mm wide at tip X 25 mm long, Gold Plated Handles
- 924-105 KOGAN Endocervical Speculum, with out locking handle, offset ring handles, 5mm jaws, 9-1/2" (24.1 cm)
- 924-110 KOGAN Endocervical Speculum, 9-1/2" (24.1 cm), with gauge and set screw, offset ring handles, fenestrated jaws, 7 X 25 mm



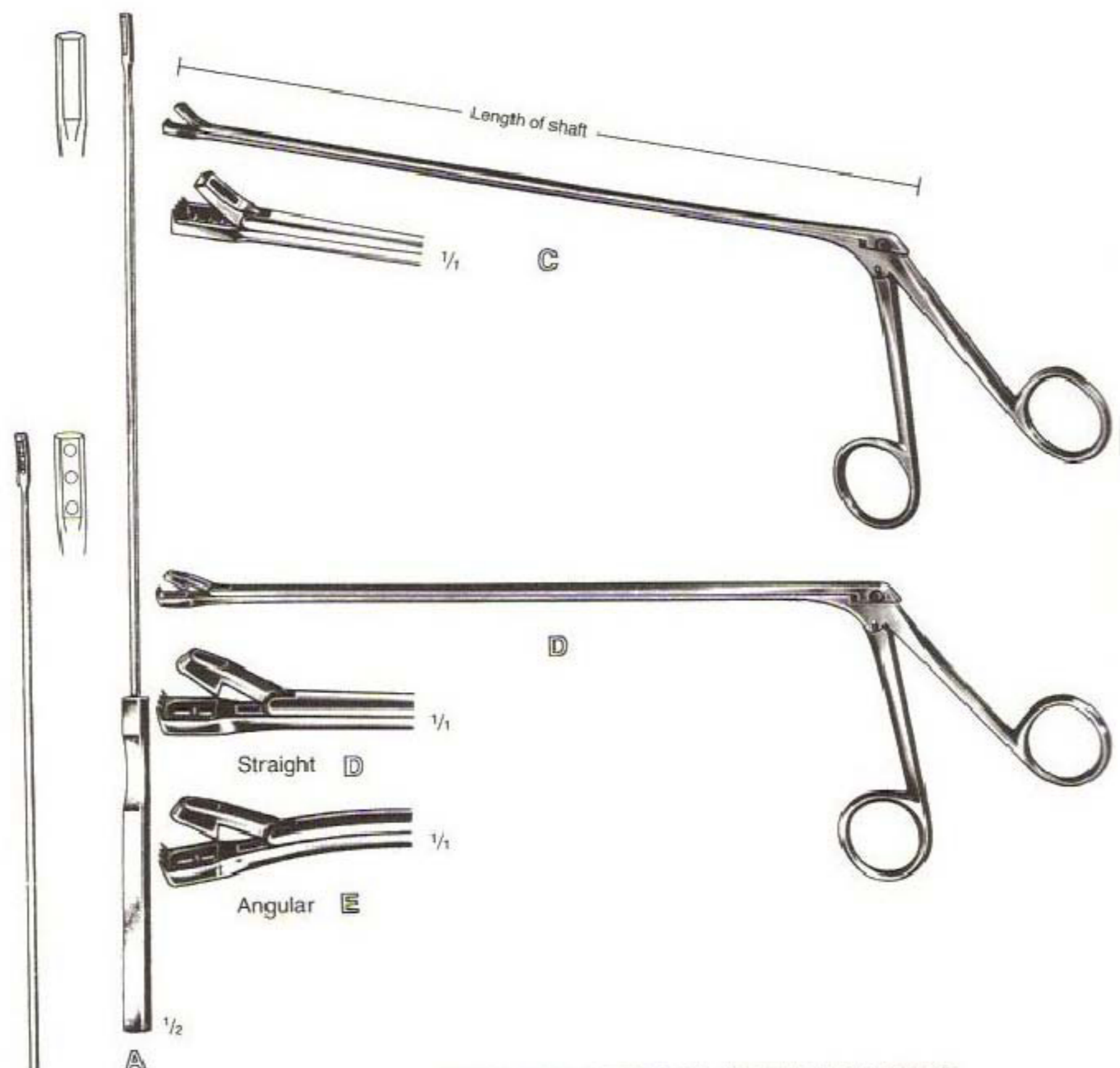

### GYNECOLOGICAL INSTRUMENTS

- A** 924-159 KEVORKIAN-YOUNGE Endometrial Curette, 3 x 12 mm, without basket, 12"
- B** 924-160 KEVORKIAN-YOUNGE Endometrial Curette, 3 x 12 mm, with basket, 12"
- C** 924-506 KEVORKIAN-YOUNGE Uterine Biopsy Forceps, 3.5 x 8.8 mm Bite, Straight, 9"
- D** 924-605 WITTNER Uterine Biopsy Forceps, 5 x 8 mm Bite, 8-1/2", Straight Tip
- E** 924-613 WITTNER Uterine Biopsy Forceps, 5 x 8mm Bite, 8-1/2", Angled Tip

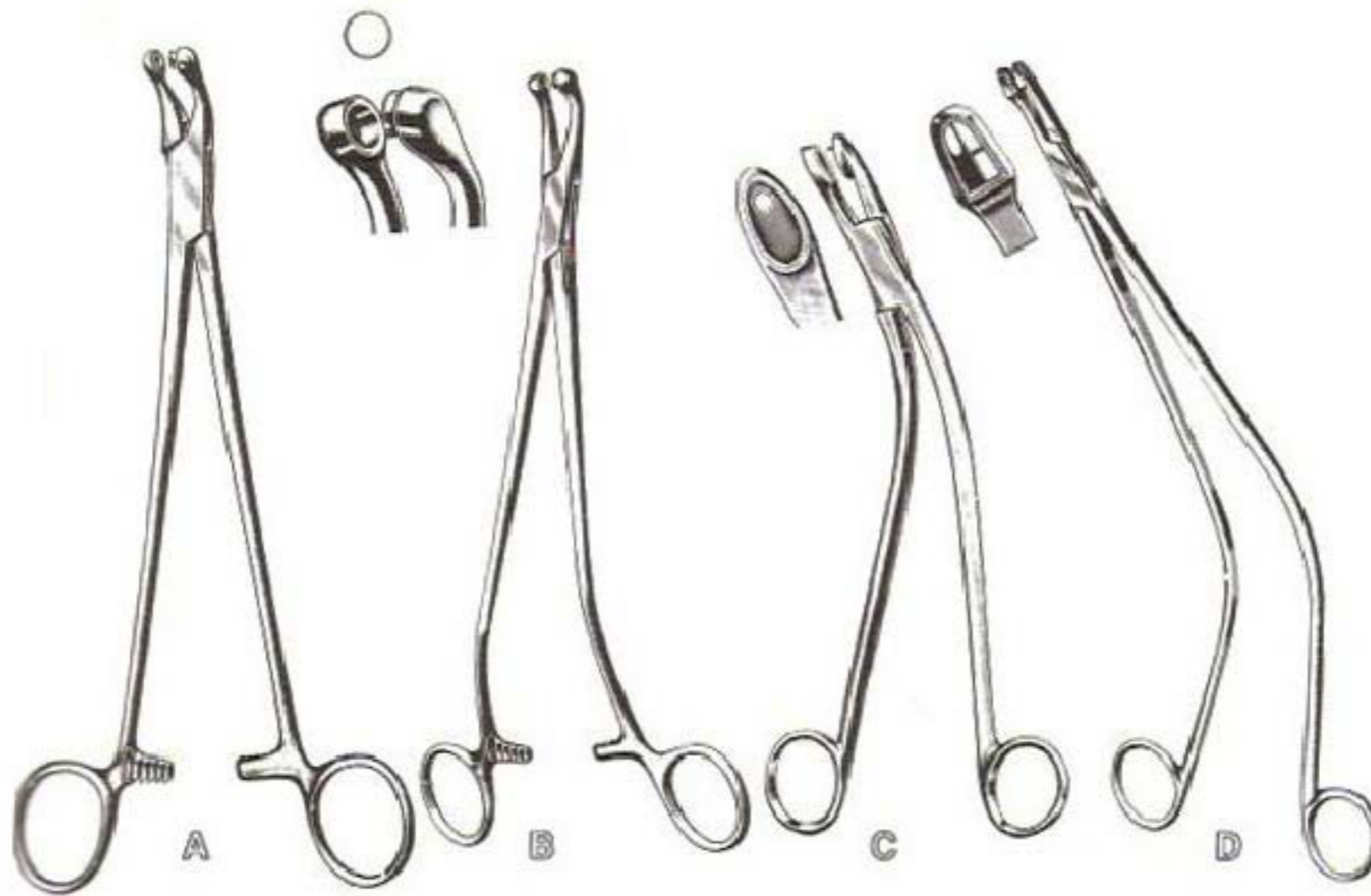

## GYNECOLOGICAL INSTRUMENTS



- A** 924-704 GAYLOR Uterine Biopsy Forceps, 8-1/2" (21.6 cm),  
Straight Shank, Curved jaws, 5 mm bite, Inter-fitted cups
- B** 924-712 THOMS-GAYLOR Uterine Biopsy Forceps, 9-1/2" (24.1 cm),  
Angled shank, Curved jaws, 5 mm Bite, Inter-fitted cups
- C** 924-803 GELLHORN Uterine Biopsy Forceps, 9-1/2" (24.1 cm),  
Curved, Oval Bite, 5 X 8 mm
- D** 924-902 SCHUBERT Uterine Biopsy Forceps, 8-1/2" (21.6 cm), straight  
924-951 SCHUBERT Uterine Biopsy Forceps, 8-1/2" (21.6 cm), curved

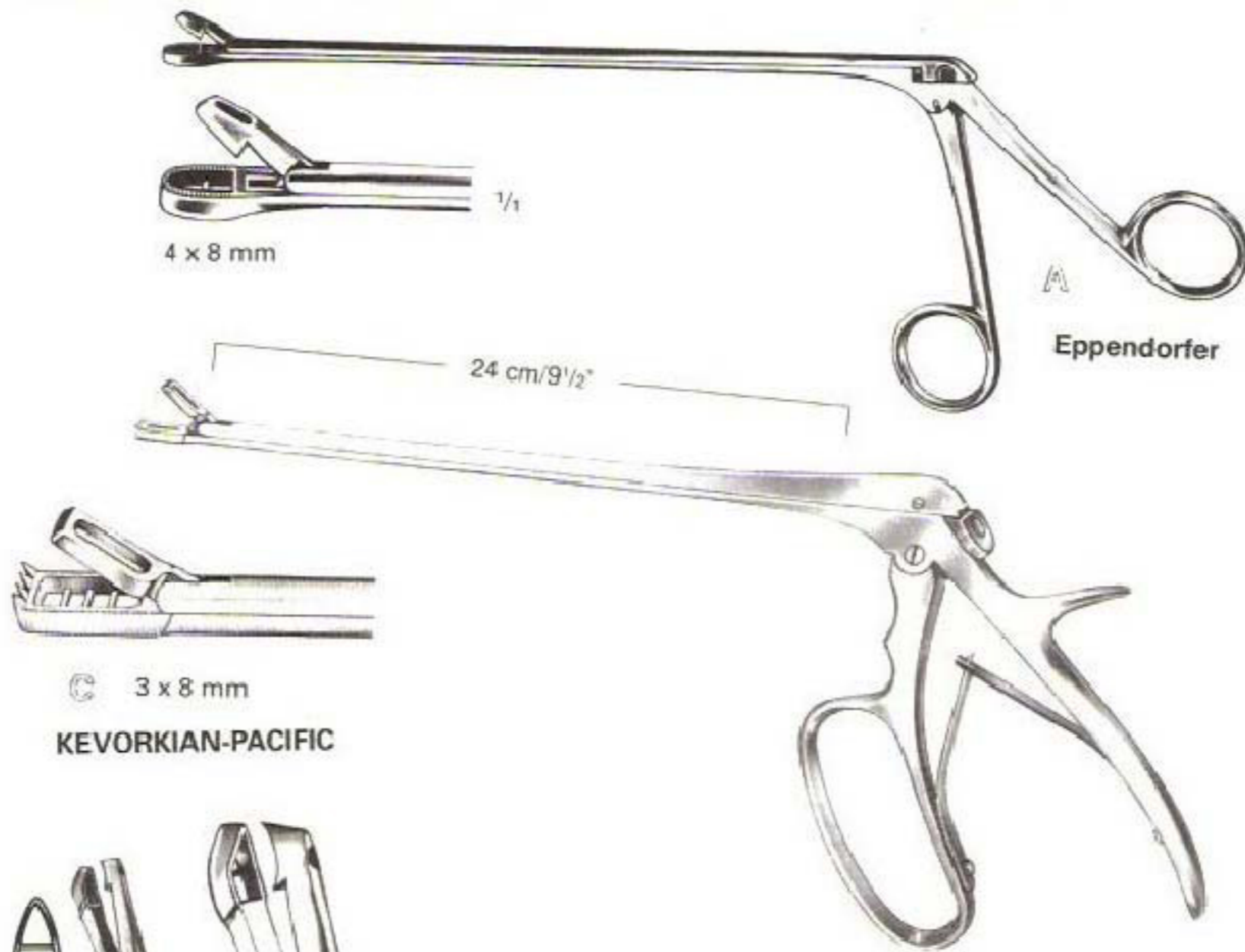

## GYNECOLOGICAL INSTRUMENTS

- A 924-954 EPPENDORFER Uterine Biopsy Forceps, 8-1/2" (21.6 cm) shaft 4x8mm Bite
- B 924-983 TISCHLER Cervical Biopsy Punch forceps, Pointed jaw, 10-1/2" (26.7 cm)
- C 924-984 KEVORKIAN-PACIFIC Biopsy Punch Forceps, 8-1/2", 8mm x 3mm Bite



## GYNECOLOGICAL INSTRUMENTS

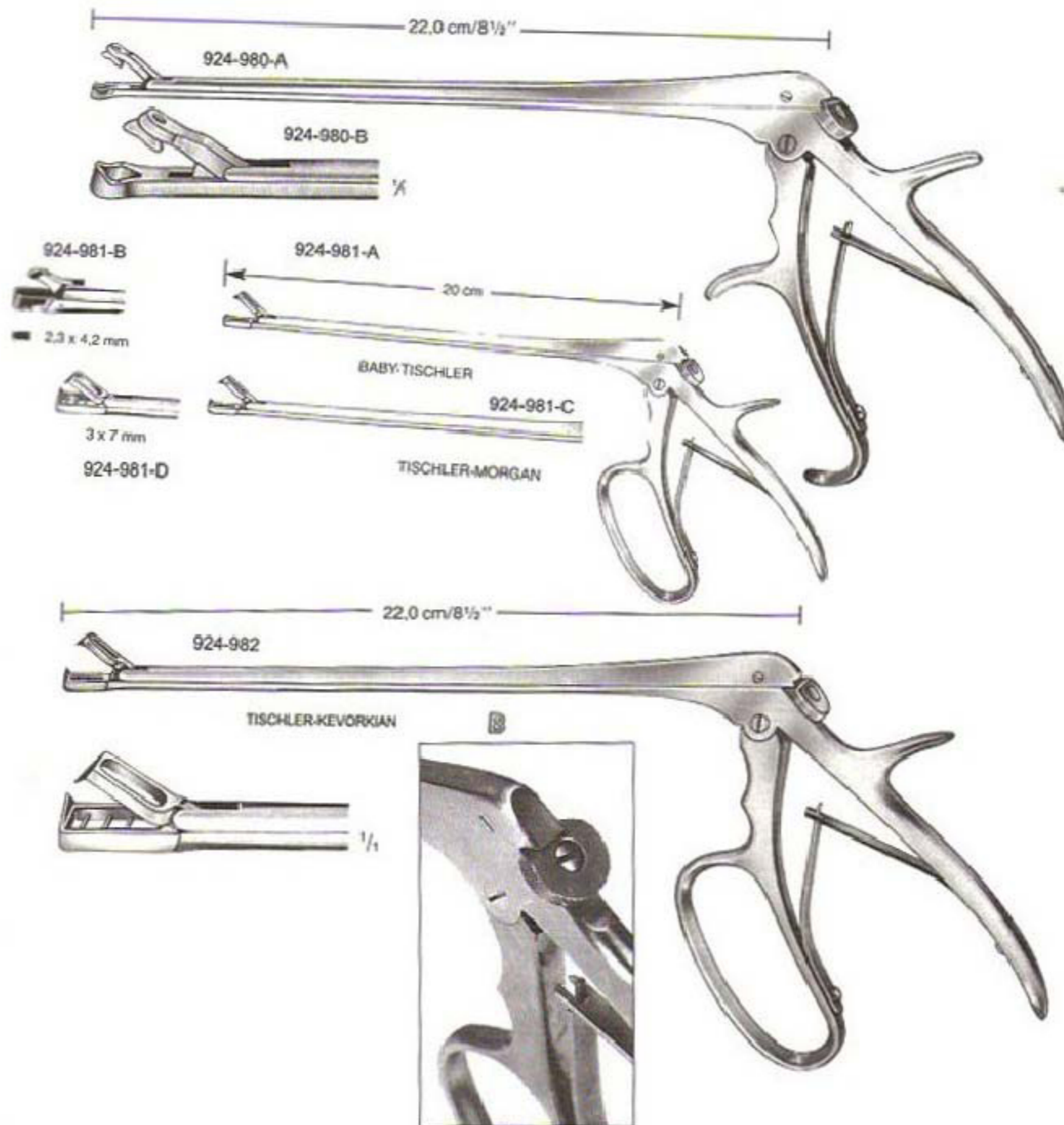

- 924-980-A Burke Biopsy Forceps 4.5 x 3 mm, with locking mechanism 20 cm, 8" shaft
- 924-980-B Burke Biopsy Forceps 7 x 5 mm, with locking mechanism 20 cm, 8" shaft
- 924-981-A Baby Tischler Cervical Forceps 4.2 x 2.3 mm, with locking mechanism 20 cm, 8" shaft
- 924-981-B Baby Tischler Cervical Forceps 4.2 x 2.3 mm, with locking 25.4 cm, 10" shaft
- 924-981-C Tischler Morgan Cervical Forceps 7 x 3 mm, with locking mechanism, 20 cm, 8" shaft
- 924-981-D Tischler Morgan Cervical Forceps 7 x 3 mm, with locking mechanism, 25.4 cm 10" shaft
- 924-982 Tischler-Kevorkian Cervical Forceps with locking mechanism, 20 cm, 8" shaft

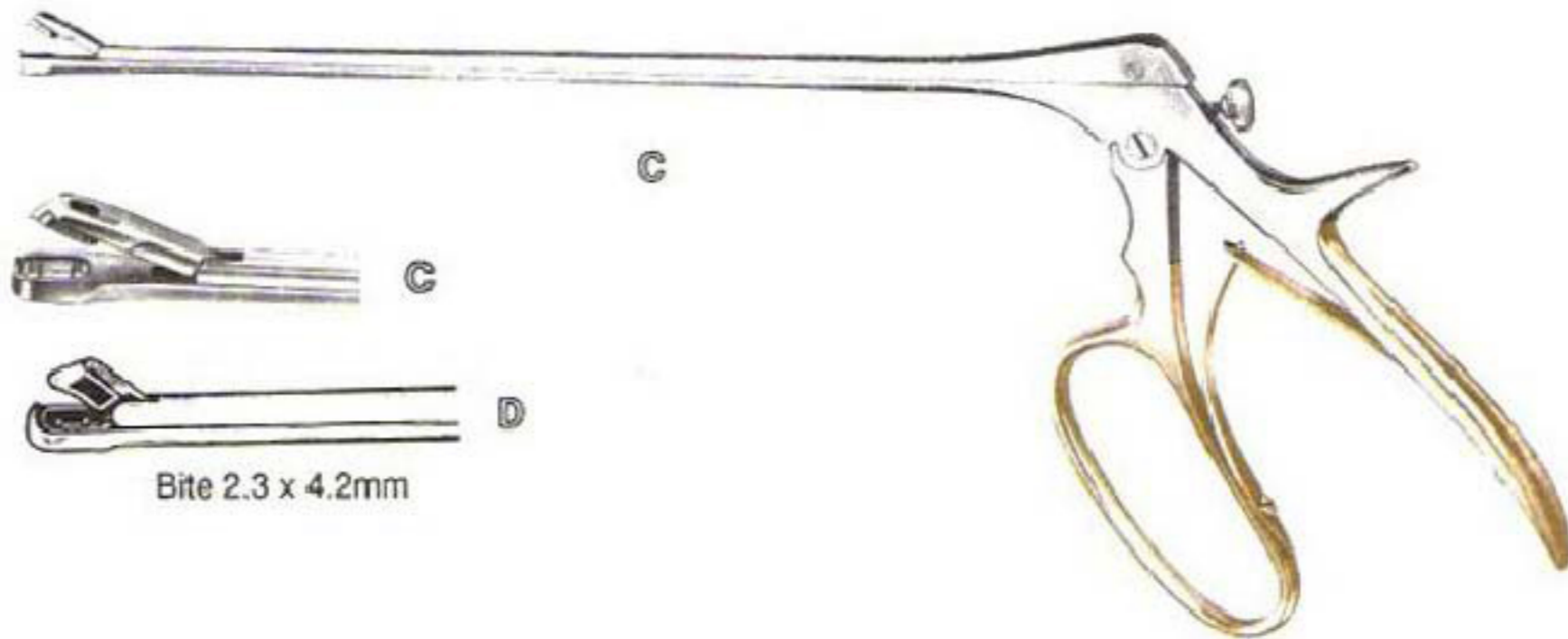
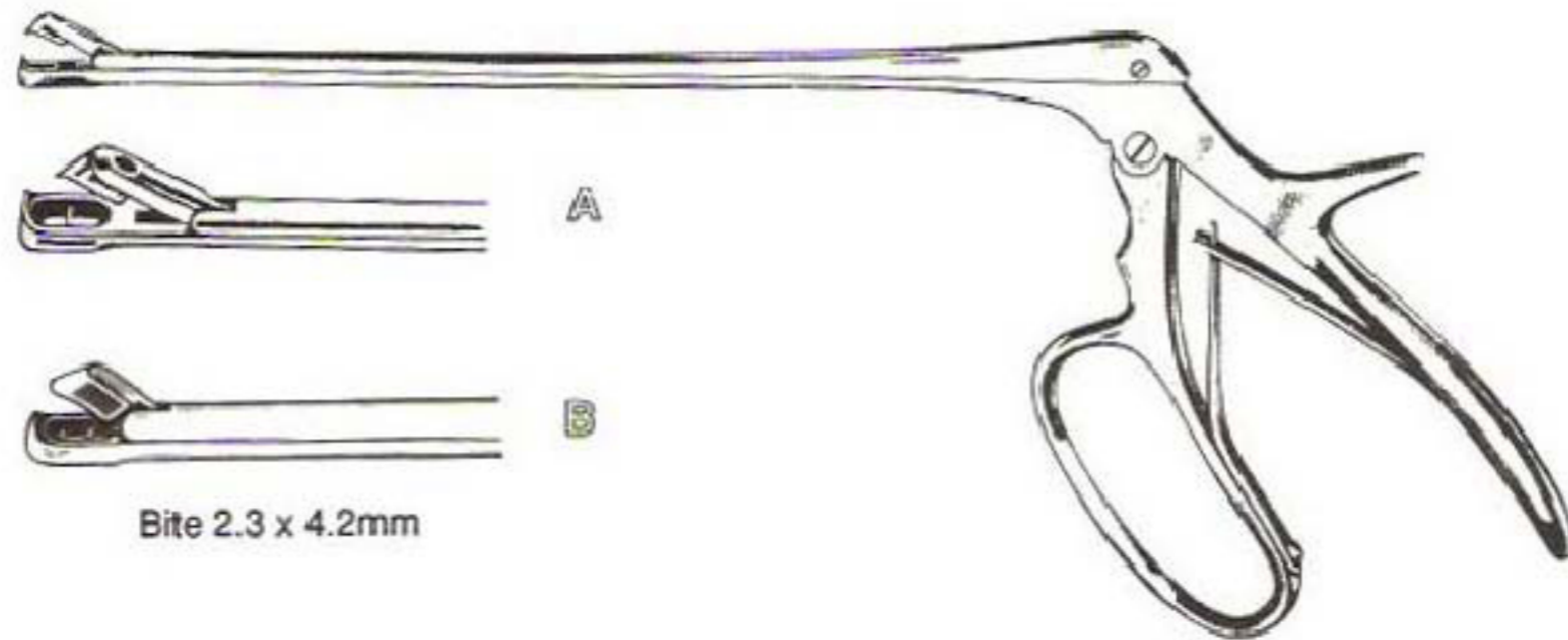

## GYNECOLOGICAL INSTRUMENTS

- A** 924-985 Tischler-Morgan Cervical Biopsy Forceps, Pistol Grip  
9" Shaft, Bite 3 x 7mm
- B** 924-986 "Baby" Tischler Cervical Biopsy Forceps, Pistol Grip  
9" Shaft, Bite 2.3 x 4.2mm
- C** 924-987 Tischler Cervical Biopsy Forceps, Pistol Grip with  
Set Screw, Gold Plated Handle - 9" Shaft, Bite 3 x 7mm
- D** 924-988 "Baby" Tischler Cervical Biopsy Forceps, Pistol Grip  
Set Screw, Gold Plated Handle - 9" Shaft, Bite 2.3 x 4.2mm

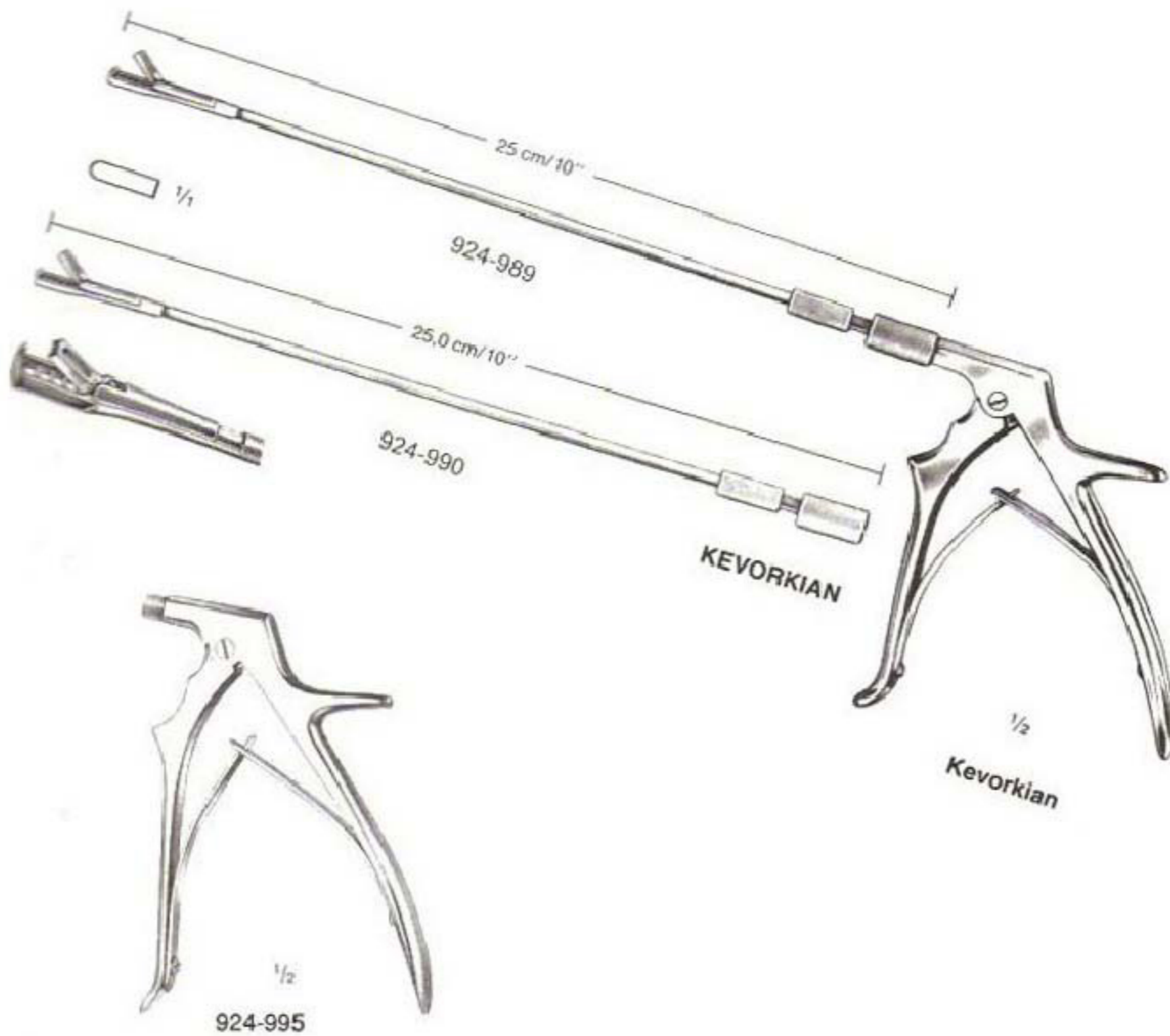

## GYNECOLOGICAL INSTRUMENTS

### ROTATING BIOPSY FORCEPS

Fine Rotating Shaft Uterine Biopsy Forceps has a 360 degrees rotating shaft to take Biopsies from any cervical surface without obstruction. Fully interchangeable tip designed to fit Kevorkian, Tischler and Eppendorfer Tips.

- 924-989 Kevorkian-Younger Uterine Biopsy Forceps 3.5 x 8mm bite, Gold Plated Handle, 10" Shaft complete with pistol grip handle.
- 924-990 Kevorkian-Younger Uterine Biopsy Forceps, 10" Shaft only.
- 924-995 Handle Only for Kevorkian-Younger Uterine Biopsy Forceps

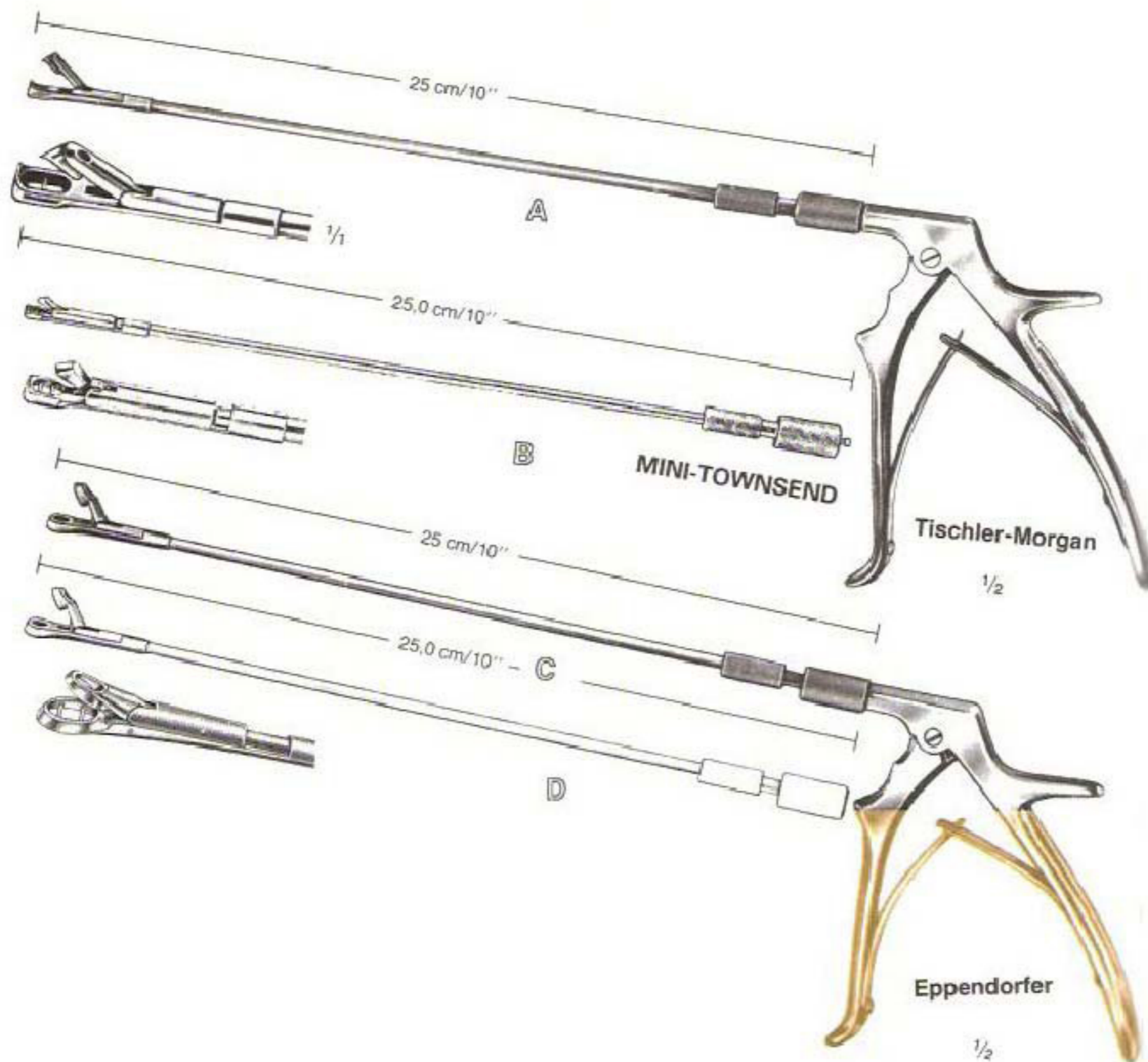

## GYNECOLOGICAL INSTRUMENTS

### ROTATING BIOPSY FORCEPS

- A** 924-991 Tischler Biopsy Forceps, 3 x 7mm Bite  
Gold Plated Handle, 10" Shaft complete with pistol grip handle.
- B** 924-992 TOWNSEND "Mini-Bite" Cervical Biopsy Punch Forceps,  
7-1/2" (19.1 cm) shaft, 4.2 X 2.3 X 1 mm bite
- C** 924-996 Eppendorfer Biopsy Forceps, Oval 4.5 x 6.5mm bite.  
Gold Plated Handle, 10" Shaft complete with pistol grip handle.
- D** 924-998 Eppendorfer Biopsy Forceps, 10" Shaft only.



## GYNECOLOGICAL INSTRUMENTS

<b>A</b>	925-016	Simon Cup Curette, Size 1
	925-024	Simon Cup Curette, Size 2
	925-032	Simon Cup Curette, Size 3
	925-040	Simon Cup Curette, Size 4
	925-057	Simon Cup Curette, Size 5
	925-069	Simon Cup Curette, Size 6





## GYNECOLOGICAL INSTRUMENTS

- |          |         |   |
|----------|---------|---|
| <b>A</b> | 925-105 | Sims Uterine Curette, Size 00, Sharp, 10 ¼", Malleable Shanks           |
|          | 925-107 | Sims Uterine Curette, Size 0, Sharp, 10 ¼", Malleable Shanks            |
|          | 925-115 | Sims Uterine Curette, Size 1, Sharp, 10 ¼", Malleable Shanks            |
|          | 925-123 | Sims Uterine Curette, Size 2, Sharp, 10 ¼", Malleable Shanks            |
|          | 925-131 | Sims Uterine Curette, Size 3, Sharp, 10 ¼", Malleable Shanks            |
|          | 925-149 | Sims Uterine Curette, Size 4, Sharp, 10 ¼", Malleable Shanks            |
|          | 925-156 | Sims Uterine Curette, Size 5, Sharp, 10 ¼", Malleable Shanks            |
|          | 925-164 | Sims Uterine Curette, Size 6, Sharp, 10 ¼", Malleable Shanks            |
| <b>B</b> | 925-214 | Thomas Uterine Curette, Size 1, Blunt, 10 ¼", Malleable Shanks          |
|          | 925-222 | Thomas Uterine Curette, Size 2, Blunt, 10 ¼", Malleable Shanks          |
|          | 925-230 | Thomas Uterine Curette, Size 3, Blunt, 10 ¼", Malleable Shanks          |
|          | 925-248 | Thomas Uterine Curette, Size 4, Blunt, 10 ¼", Malleable Shanks          |
|          | 925-255 | Thomas Uterine Curette, Size 5, Blunt, 10 ¼", Malleable Shanks          |
|          | 925-263 | Thomas Uterine Curette, Size 6, Blunt, 10 ¼", Malleable Shanks          |
| <b>C</b> | 925-300 | Hunter Large Uterine Curette, Blade w/3 cm working length, 8" (20.3 cm) |



## GYNECOLOGICAL INSTRUMENTS

- |          |         |   |
|----------|---------|---|
| <b>A</b> | 925-105 | Sims Uterine Curette, Size 00, Sharp, 10 ¼", Malleable Shanks           |
|          | 925-107 | Sims Uterine Curette, Size 0, Sharp, 10 ¼", Malleable Shanks            |
|          | 925-115 | Sims Uterine Curette, Size 1, Sharp, 10 ¼", Malleable Shanks            |
|          | 925-123 | Sims Uterine Curette, Size 2, Sharp, 10 ¼", Malleable Shanks            |
|          | 925-131 | Sims Uterine Curette, Size 3, Sharp, 10 ¼", Malleable Shanks            |
|          | 925-149 | Sims Uterine Curette, Size 4, Sharp, 10 ¼", Malleable Shanks            |
|          | 925-156 | Sims Uterine Curette, Size 5, Sharp, 10 ¼", Malleable Shanks            |
|          | 925-164 | Sims Uterine Curette, Size 6, Sharp, 10 ¼", Malleable Shanks            |
| <b>B</b> | 925-214 | Thomas Uterine Curette, Size 1, Blunt, 10 ¼", Malleable Shanks          |
|          | 925-222 | Thomas Uterine Curette, Size 2, Blunt, 10 ¼", Malleable Shanks          |
|          | 925-230 | Thomas Uterine Curette, Size 3, Blunt, 10 ¼", Malleable Shanks          |
|          | 925-248 | Thomas Uterine Curette, Size 4, Blunt, 10 ¼", Malleable Shanks          |
|          | 925-255 | Thomas Uterine Curette, Size 5, Blunt, 10 ¼", Malleable Shanks          |
|          | 925-263 | Thomas Uterine Curette, Size 6, Blunt, 10 ¼", Malleable Shanks          |
| <b>C</b> | 925-300 | Hunter Large Uterine Curette, Blade w/3 cm working length, 8" (20.3 cm) |



## GYNECOLOGICAL INSTRUMENTS

- A** 925-676 Heaney-Ballentine Hysterectomy Forceps, 8-1/2", longitudinal serrations, single tooth, straight
- B** 925-701 Heaney-Ballentine Hysterectomy Forceps, 8-1/4", longitudinal serrations, single tooth, curved
- C** 925-800 Phaneuf Uterine Artery Forceps, Straight, 8-1/2"  
925-818 Phaneuf Uterine Artery Forceps, Angular, 8-1/2"
- D** 925-825 Wertheim-Cullen Pedicle Clamp, 8-1/2", Right Angle Jaws, 2" Long



940-056  
940-064  
940-072



940-106  
940-114



940-205  
940-213



940-254

## OBSTETRICAL INSTRUMENTS

- |         |  |
|---------|--|
| 940-056 | Dee Lee Obstetrical Forceps, 12"                   |
| 940-064 | Dee Lee Obstetrical Forceps, 14"                   |
| 940-072 | Dee Lee Obstetrical Forceps, 15-1/4"               |
| 940-106 | Elliot Obstetrical Forceps, 12-1/2"                |
| 940-114 | Elliot Obstetrical Forceps, 15-1/2"                |
| 940-205 | Simpson Obstetrical Forceps, 12"                   |
| 940-213 | Simpson Obstetrical Forceps, 14"                   |
| 940-254 | McLean-Tucker-Luikart Obstetrical Forceps, 15-1/2" |



940-304



940-353



940-403



940-452



940-502

## OBSTETRICAL INSTRUMENTS

- 940-304 Piper Obstetrical Forceps, 17"
- 940-353 Kieland Obstetrical Forceps, 15-1/2"
- 940-403 Luikart Obstetrical Forceps, 15-1/2"
- 940-452 Simpson-Luikart Obstetrical Forceps, 14"
- 940-502 McLean-Luikart Obstetrical Forceps, 15-1/2"

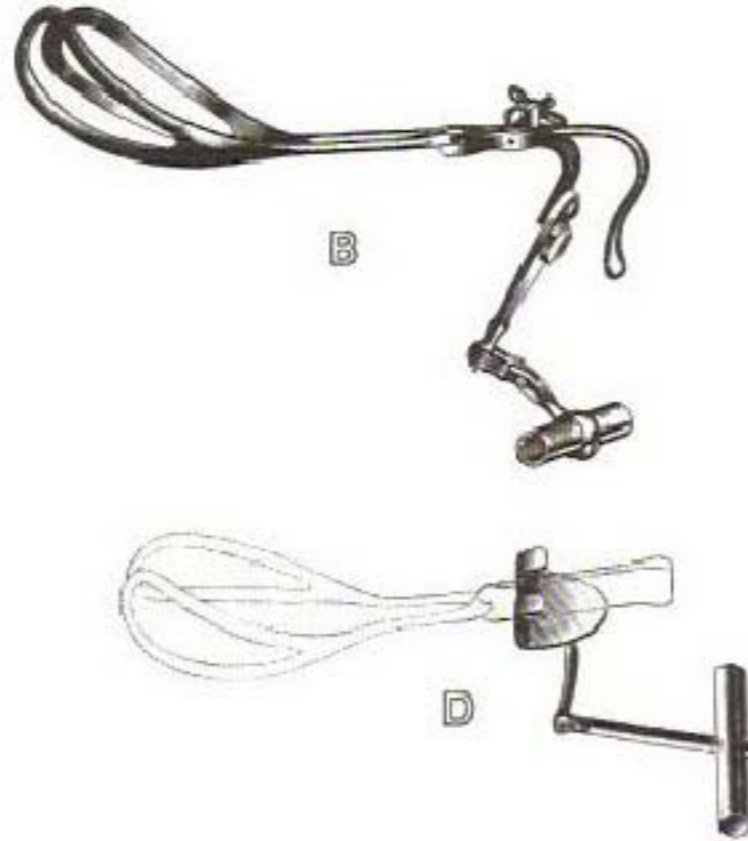

## OBSTETRICAL INSTRUMENTS

- A 940-551 Kieland-Luikart Obstetrical Forceps, 15-1/2"
- B 940-601 De Wey Obstetrical Forceps, Axis Traction, 14"
- C 940-650 Barton Obstetrical Forceps, 14", one hinged blade
- D 940-759 Bill Axis Handle
- E 940-908 Murless Fetal Head Extractor, 10"  
with hinged shaft and sliding collar lock

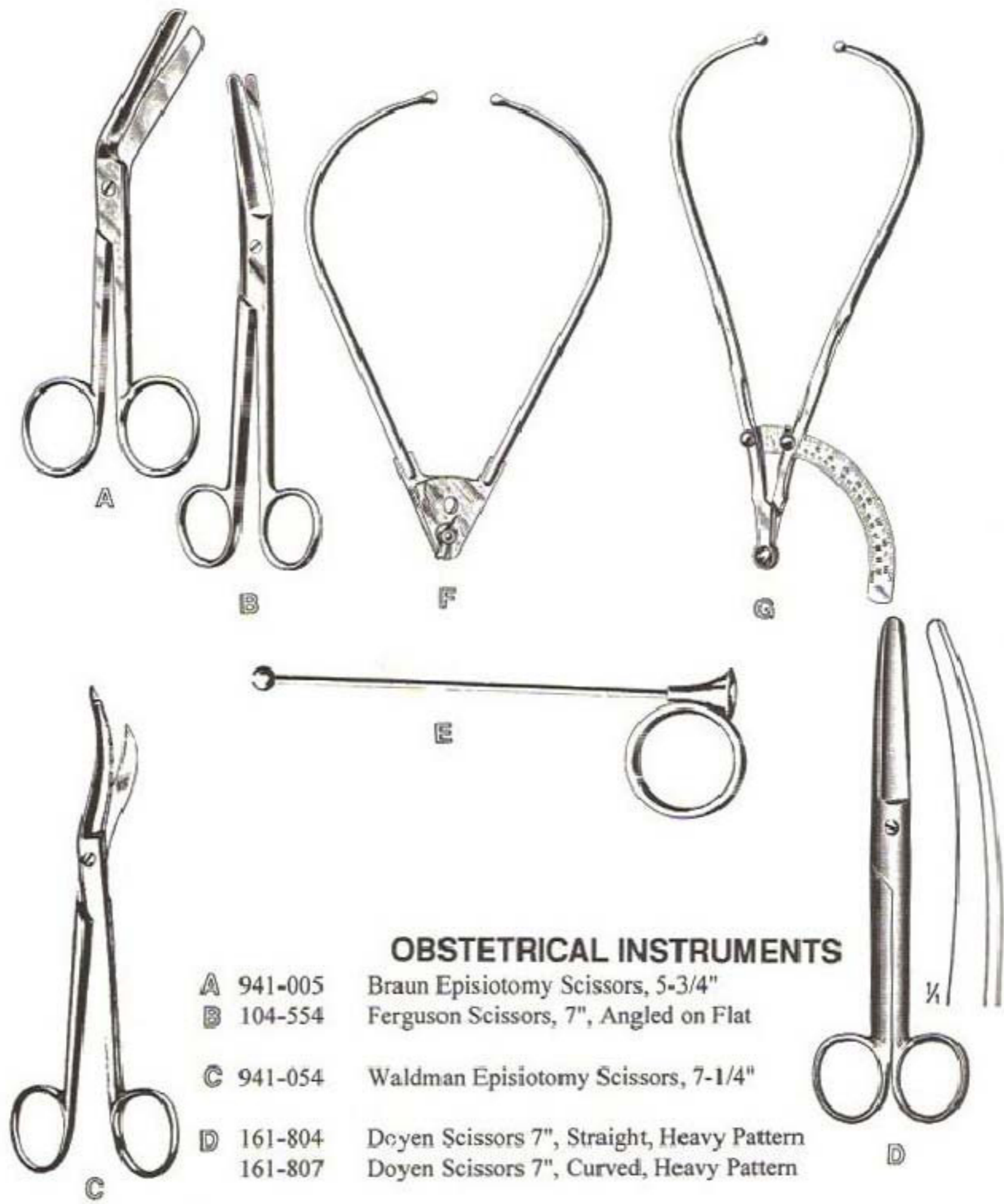

### OBSTETRICAL INSTRUMENTS

- A 941-005 Braun Episiotomy Scissors, 5-3/4"
- B 104-554 Ferguson Scissors, 7", Angled on Flat
- C 941-054 Waldman Episiotomy Scissors, 7-1/4"
- D 161-804 Doyen Scissors 7", Straight, Heavy Pattern  
161-807 Doyen Scissors 7", Curved, Heavy Pattern
- E 941-153 Iowa Trumpet Needle Guide, 6"
- F 941-203 Collyer Pelvimeter Graduated in Inches and Centimeters
- G 941-252 Martin Pelvimeter, Graduated in Inches and Centimeters



A



B



C



D



E

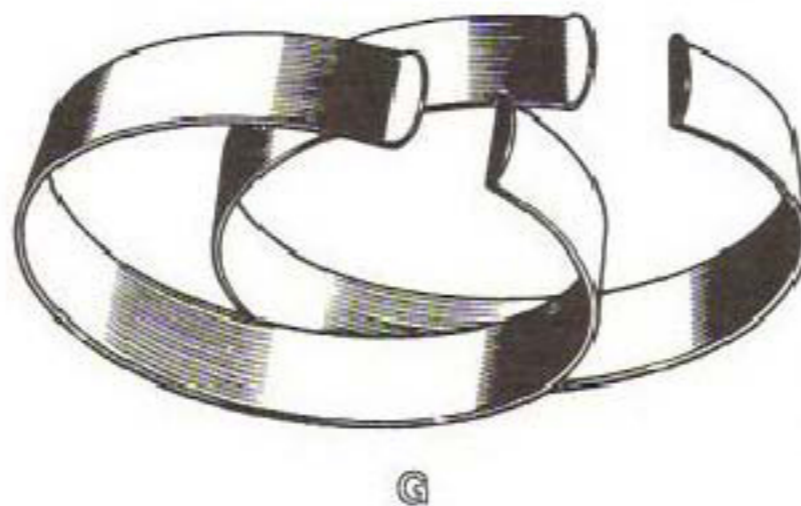

G

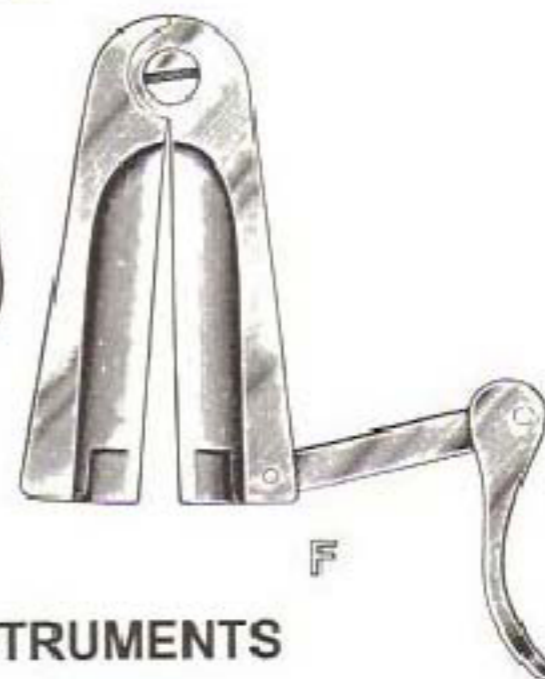

F

## OBSTETRICAL INSTRUMENTS

- |   |         |  |
|---|---------|--|
| A | 941-351 | Bumm Placenta Curette, 20mm Blade, 11" Sharp Malleable Shank |
| B | 941-518 | Barrett Placenta Forceps, Large, 10"                         |
| C | 941-708 | Kelly Placenta Forceps, 12"                                  |
| D | 941-003 | Iowa (Mengert) Membrane Forceps, 10"                         |
| E | 942-102 | Umbilical Scissors, 4"                                       |
| F | 942-152 | Mogen Circumcision Clamp                                     |
| G | 942-154 | Bethea Sheet Holders   |





740-033



740-005



200-520

## POST MORTEM INSTRUMENTS

- 740-005 SWISS Jeweler style Forceps, style 5, 4-3/8" (11.2 cm)
- 740-033 SWISS Jeweler style Forceps, style 3C, 4-3/8" (11.2 cm)
- 965-622 BRUNETTI Chisel, Right, 11" (27.9cm)
- 965-624 BRUNETTI Chisel, Left, 11" (27.9cm)
- 200-520 HALSTED Mosquito Forceps, straight, extra delicate



## POST MORTEM INSTRUMENTS

- |          |         |  |
|----------|---------|--|
| <b>A</b> | 822-180 | Dubois Scissors, 10 1/2" (26.7 cm) Straight, Blunt Points<br>Extra Heavy Pattern |
| <b>B</b> | 822-185 | Dubois Scissors, 10 1/2" (26.7 cm) Curved, Blunt Points<br>Extra Heavy Pattern   |
| <b>C</b> | 965-580 | Enterotomy Scissors 8", With Probe Point   |
| <b>D</b> | 965-583 | Enterotomy Scissors 8", With Hook Blade  |
| <b>E</b> | 965-558 | Enterotomy Scissors 8", With Round Probe Point                                   |

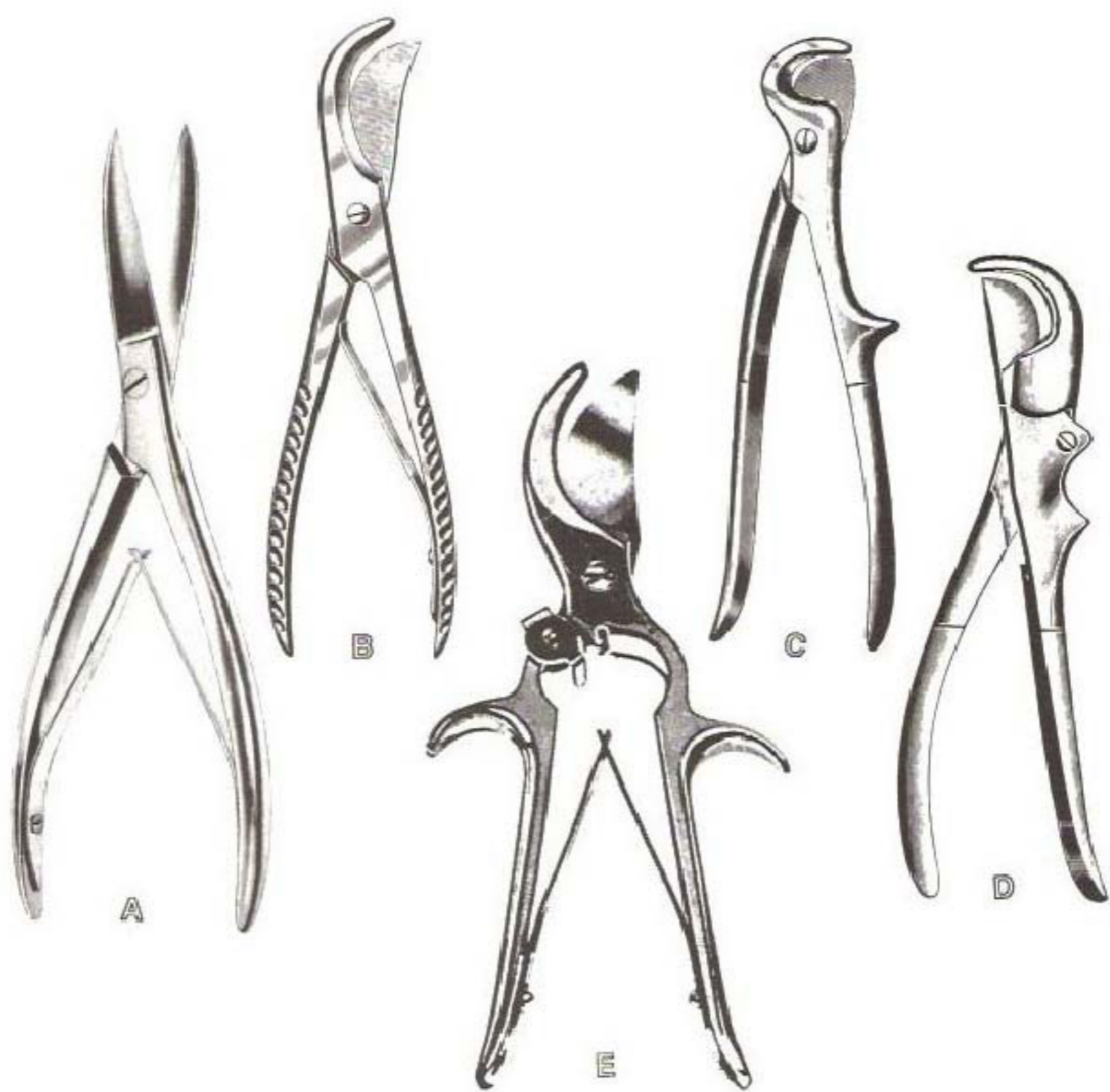

### POST MORTEM INSTRUMENTS

- A 965-600 Plain Bone Shears, 2" Jaws
- B 965-605 Rib Shears Plain, Curved, Screw Lock
- C 663-609 Stille Pattern Rib Shears, 8 1/2"
- D 663-302 Gluck Rib Shears, 8 1/2"
- E 965-620 Constable Shears, 2" Cutting Jaws, 9"



## POST MORTEM INSTRUMENTS

A	965-625	Dissecting Tenaculum 6 ½" (16.5 cm), Sharp Points
B	965-630	Aneurysm Needle 6 ½" (16.5 cm), Blunt Tip with Eye
C	965-635	Triple Chain Hook, Three Steel Hooks on Ring
D	965-640	Virchow Skull Breaker 3" (7.6 cm), Blade 1 ½" (1.3 cm)
E	704-972	Post Mortem Hammer 9 ½" (24.1 cm), with Hook Handle
F	965-650	Post Mortem Hammer 10" (25 cm), with Hook Handle

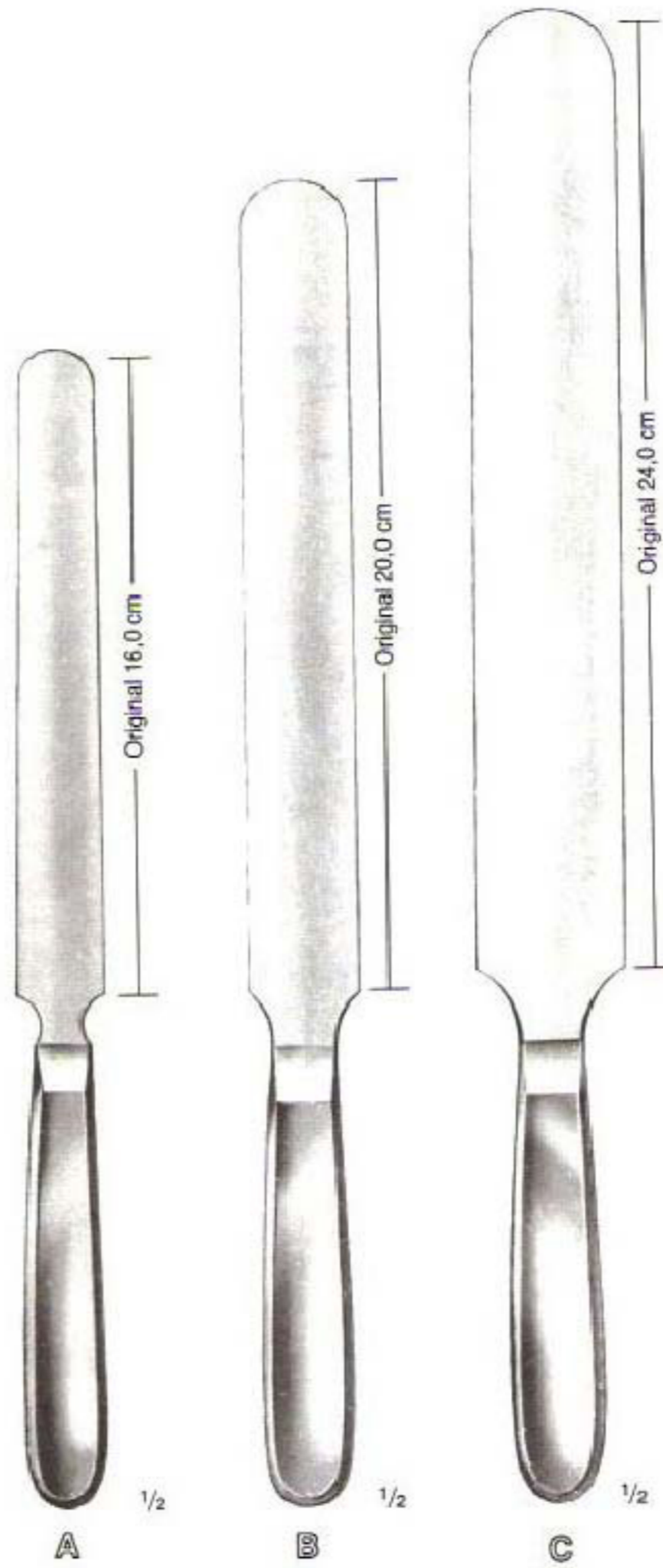

### POST MORTEM INSTRUMENTS

- |          |         |  |
|----------|---------|--|
| <b>A</b> | 965-655 | Virchow Post Mortem Knife 12 1/2", Blade Length 6 1/4" (16.0 cm) |
| <b>B</b> | 965-660 | Virchow Post Mortem Knife 13", Blade Length 8" (20.0 cm)         |
| <b>C</b> | 965-665 | Virchow Post Mortem Knife 15", Blade Length 9 1/2" (24.0 cm)     |



### **SPECIMEN OBJECT DISCS**

Precisely Machined to accurate dimensions and chrome plated. Available in four sizes to fit most microtomes and cryostats. Straight shank.

### **POST MORTEM INSTRUMENTS**

<b>A</b>	965-670	Straight Shank Microtome Object Discs 7/8" (2.2 cm)
	965-675	Straight Shank Microtome Object Discs 1 1/8" (2.9 cm)
	965-680	Straight Shank Microtome Object Discs 1 1/2" (3.8 cm)
	965-685	Straight Shank Microtome Object Discs 2" (5.1 cm)
<b>B</b>	965-690	Cleaning Brush, Nylon, Pkg. of 3
	965-695	Cleaning Brush, Stainless Steel, Pkg. of 3



## SURGEONS CLEANING BRUSHES

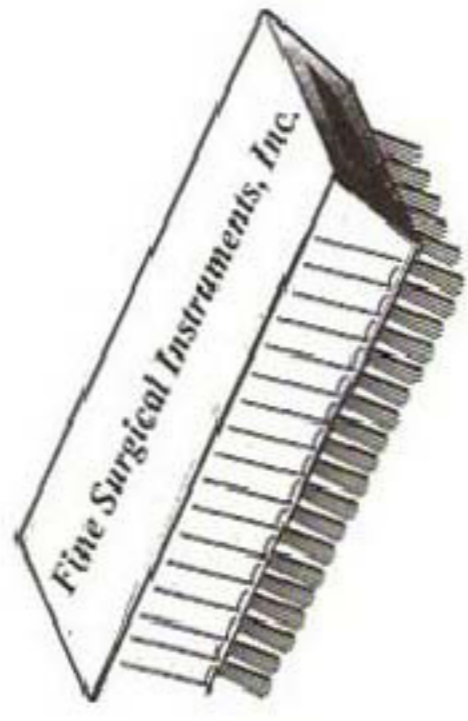

**SURGEONS BRUSH**  
 965-700 Standard  
 965-702 Standard, Pack of 12

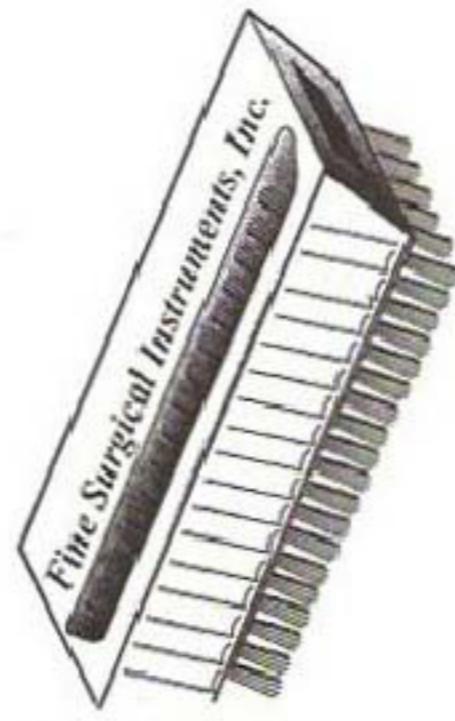

**SURGEONS BRUSH**  
 965-704 With Nail Scrubber  
 965-706 With Nail Scrubber, Pack of 12



**SURGEONS BRUSH**  
 965-708 With Channel Back  
 965-710 With Channel Back, Pack of 12



**INSTRUMENT CLEANING BRUSH- BRISTLE END**  
 965-712 2-1/4"x1/8"x12" long, Pack of 3  
 965-714 2-1/4"x3/8"x15" long, Pack of 3  
 965-716 3-1/2"x1"x15" long, Pack of 3



**CLEANING BRUSH**  
 965-718 Small 6" long 1/2" Diameter  
 965-720 Medium 7" long 5/8" Diameter  
 965-722 Large 7 1/2" long 3/4" Diameter  
 965-724 Package of 3: Small, Medium, Large



**INSTRUMENT CLEANING BRUSHES**  
 965-690 Nylon bristles, Pack of 3  
 965-692 Nylon bristles, Pack of 12  
 965-694 Nylon bristles, Pack of 24  
 965-695 Stainless steel bristles, Pack of 3  
 965-697 Stainless steel bristles, pack of 12  
 965-699 Stainless steel bristles, Pack of 24



## LABORATORY PRODUCTS



### STORAGE CONTAINERS (Beakers) WITH COVERS

GS-35-200	Storage Container w/Cover, 1-1/4 Qt., 4-9/16" x 5-3/4"
GS-35-202	Storage Container w/Cover, 2 Qt., 5-7/16" x 6-5/8"
GS-35-204	Storage Container w/Cover, 3-1/4 Qt., 6-1/2" x 7"
GS-35-206	Storage Container w/Cover, 4-3/4 Qt., 7-3/8" x 7-7/8"
GS-35-208	Storage Container w/Cover, 6-1/8 Qt., 8" x 8-3/4"
GS-35-210	Storage Container w/Cover, 8 Qt., 8-3/4" x 9-5/8"
GS-35-212	Storage Container w/Cover, 12 Qt., 9-5/8" x 11"



### STORAGE CONTAINERS WITH COVER AND HANDLES

GS-35-214	Storage Containers w/ Handles, 8 Qt., 9-3/4" x 7-5/8"
GS-35-216	Storage Containers w/ Handles, 12 Qt., 10-2/3" x 9"
GS-35-218	Storage Containers w/ Handles, 16 Qt., 13" x 9"
GS-35-220	Storage Containers w/ Handles, 20 Qt., 13" x 11"
GS-35-222	Storage Containers w/ Handles, 24 Qt., 13" x 13"
GS-35-224	Storage Containers w/ Handles, 32 Qt., 15" x 12-1/2"
GS-35-226	Storage Containers w/ Handles, 40 Qt., 15" x 16"



### GRIFFIN STYLE BEAKERS

GS-35-228	Griffin Style Beakers, 125 ml., (5.5 x 6.5 cm), 2-1/8" x 2-5/8"
GS-35-230	Griffin Style Beakers, 250 ml., (6.5 x 8.5 cm), 2-5/8" x 3-1/4"
GS-35-232	Griffin Style Beakers, 600 ml., (8.5 x 11.5 cm), 3-3/8" x 4-5/8"
GS-35-234	Griffin Style Beakers, 1200 ml., (10.5 x 15.5 cm), 4-1/8" x 6-1/16"
GS-35-236	Griffin Style Beakers, 2000 ml., (12.5 x 18 cm), 4-7/8" x 7-1/8"
GS-35-238	Griffin Style Beakers, 3000 ml., (14.5 x 21 cm), 5-1/2" x 8-1/4"
GS-35-240	Griffin Style Beakers, 4000 ml., (15.5 x 23 cm), 6-1/8" x 8-1/8"



### SOLUTION PAILS

GS-35-242	Solution Pail W/ Cover, 13 Qt., 11-5/8" x 9-1/4"
GS-35-244	Solution Pail W/ Cover, 16 Qt., 11-3/8" x 10-1/8"





## INSTRUMENT TRAYS WITH FLAT COVER

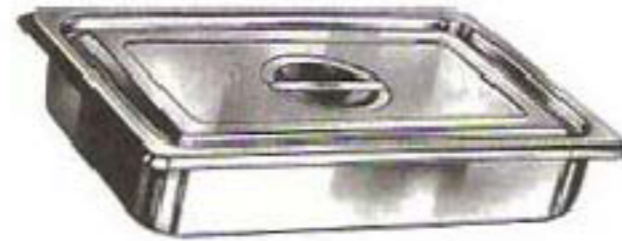

- GS-35-246 Instrument Tray w/ Flat Cover, 12-1/4" x 7-3/4" x 2-1/4"
- GS-35-248 Instrument Tray w/ Flat Cover, 10 x 8-1/4" x 2-1/2"
- GS-35-250 Instrument Tray w/ Flat Cover, 10 x 8-1/4" x 4"
- GS-35-252 Instrument Tray w/ Flat Cover, 16-1/2" x 10" x 2-1/2"
- GS-35-254 Instrument Tray w/ Flat Cover, 16-1/2" x 10" x 4"
- GS-35-256 Instrument Tray w/ Flat Cover, 13-7/8" x 12-7/8" x 2-1/2"
- GS-35-258 Instrument Tray w/ Flat Cover, 13-7/8" x 12-7/8" x 4"

## STERILIZATION TRAYS/BATH SETS (HOT/COLD)



- GS-35-260 Sterilization Tray, Solid, 20-3/4" x 12-3/4" x 4"
- GS-35-262 Sterilization Tray, Perforated, 20-3/4" x 12-3/4" x 2-1/2"
- GS-35-264 Sterilization Tray, Solid, 20-3/4" x 12-3/4" x 6"
- GS-35-266 Sterilization Tray, Perforated, 20-3/4" x 12-3/4" x 4"
- GS-35-268 Sterilization Tray, Solid, 12-3/4" x 10-3/8" x 4"
- GS-35-270 Sterilization Tray, Perforated, 12-3/4" x 10-3/8" x 2-1/2"
- GS-35-272 Sterilization Tray, Solid, 12-3/4" x 10-3/8" x 6"
- GS-35-274 Sterilization Tray, Perforated, 12-3/4" x 10-3/8" x 4"
- GS-35-276 Flat, Solid Covers For Sterilization Trays,  
Fits GS-35-260 to GS-35-266
- GS-35-278 Flat, Solid Covers For Sterilization Trays,  
Fits GS-35-268 to GS-35-274



## PATIENT CARE PRODUCTS

### BEDSIDE TRAYS



- GS-35-280 Bedside Tray w/Rolled Bead, 10" x 6-1/2" x 3/4"  
GS-35-282 Bedside Tray w/Rolled Bead, 13-11/16" x 9-13/16" x 3/4"

### STRAIGHT-SIDED PITCHERS



- GS-35-284 Straight-Sided Pitchers, 2Qt. Capacity, 5-1/6" x 6-5/8"  
GS-35-286 Straight-Sided Pitchers, 3Qt. Capacity, 6-1/6" x 7"

### TUMBLERS



- GS-35-288 Tumblers, 7 oz. Capacity, 2-7/8" x 3-1/8"  
GS-35-290 Tumblers, 12 oz. Capacity, 3-3/16" x 4"



## PERFORATED INSTRUMENTS (MAYO) TRAYS



- GS-35-298 **MAYO** Perforated Tray, Size 10"x6-1/2"x3/4"
- GS-35-299 **MAYO** Perforated Tray, Size 13-1/2"x9-3/4"x3/4"
- GS-35-300 **MAYO** Perforated Tray, Size 15-1/2"x10-5/8"x3/4"
- GS-35-301 **MAYO** Perforated Tray, Size 17"x11-5/8"x3/4"
- GS-35-302 **MAYO** Perforated Tray, Size 19-1/2"x12-5/8"x3/4"
- GS-35-302A **MAYO** Perforated Tray, Size (54cmx41cmx1.9cm), 21-1/4"x16-1/4"x3/4"

## OBLONG-NON-PERFORATED INSTRUMENTS (MAYO) TRAYS



- GS-35-303 **MAYO** Non-Perforated Tray, Size 10"x6-1/2"x3/4"
- GS-35-304 **MAYO** Non-Perforated Tray, Size 13-1/2"x9-3/4"x3/4"
- GS-35-305 **MAYO** Non-Perforated Tray, Size 15-1/2"x10-5/8"x3/4"
- GS-35-306 **MAYO** Non-Perforated Tray, Size 17"x11-5/8"x3/4"
- GS-35-307 **MAYO** Non-Perforated Tray, Size 19-1/2"x12-5/8"x3/4"
- GS-35-308 **MAYO** Non-Perforated Tray, Size 21-1/4"x16-1/8"x3/4"



## CATHETER TRAYS WITH DOME COVERS



- GS-35-309 Catheter Tray with Dome Cover, 8-3/4"x3-1/4"x1-1/2"
- GS-35-310 Catheter Tray with Dome Cover, 8-7/8"x5"x2"
- GS-35-311 Catheter Tray with Dome Cover, 8-7/8"x5"x3"
- GS-35-312 Catheter Tray with Dome Cover, 17-1/4"x4-1/2"x2"



- GS-35-313 Instrument Catheter Tray, Flat Cover, Recessed Grip, 12-1/8" x 7-1/8" x 2-1/8"

## HIGH SIDED PERFORATED TRAYS



- GS-35-314 Instrument Tray, High Sided, Perforated, Size 8-7/8"x5"x2"
- GS-35-315 Instrument Tray, High Sided, Perforated, Size 10"x6-1/2"x2"
- GS-35-316 Instrument Tray, High Sided, Perforated, Size 12-1/4"x7-3/4"x2-1/4"
- GS-35-317 Instrument Tray, High Sided, Perforated, Size 12-3/4"x10-3/8"x2-1/2"
- GS-35-318 Instrument Tray, High Sided, Perforated, Size 16 1/2"x10"x2 1/2"
- GS-35-319 Instrument Tray, High Sided, Perforated, Size 20-3/4"x12-3/4"x2-1/2"



## BED PANS



GS-35-330 Bed Pan, Adult, Size 13-3/4"x11-1/2"x4"

GS-35-333 Bed Pan, Child, Size 12-1/8"x9-3/4"x3"



GS-35-335 Bed Pan Fracture, Size 11-7/8"x9-1/2"x2-7/8"

## MALE AND FEMALE URINALS



GS-35-336 Male Urinal - Horizontal/Vertical, Capacity 1-3/4 Quarts, Size 4-1/2"x9-1/8"

GS-35-337 Male Urinal - Vertical Only, Capacity 1-1/2 Quarts, Size 4-1/2"x9-1/8"

GS-35-337-F Female Urinal Size 8-3/4"x5-1/2" (22cm x 14cm)



### EMESIS BASINS (KIDNEY TRAYS)

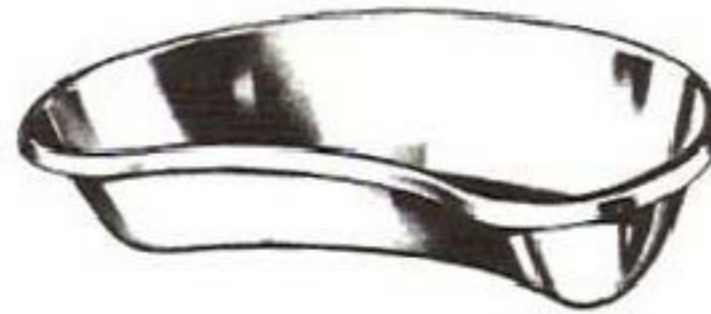

GS-35-338	Emesis Basins, Capacity, 10 Oz, (17x9x4 cm).....	6-5/8"x3-1/2"x1-1/2"
GS-35-339	Emesis Basins, Capacity, 12 Oz, (20.5x9x4 cm).....	8-1/8"x3-5/8"x1-5/8"
GS-35-340	Emesis Basins, Capacity, 26 Oz, (25x10x7.5 cm).....	9-7/8"x4-1/2"x2-1/8"
GS-35-341	Emesis Basins, Capacity, 48 Oz, (30.5x13x7 cm).....	12"x5-1/2"x2-3/8"

### FORCEPS/THERMOMETER AND APPLICATOR JARS



GS-35-342	Forceps Jar, Small, (5 1/2" x 11 cm), 2 1/4" x 4 1/4"
GS-35-343	Forceps Jar, Large, (5 1/2" x 18 cm), 2 1/4" x 7"
GS-35-344	Thermometer Jar, (2 1/2" x 10 cm), 1" x 4"
GS-35-345	Applicator Jar, Capacity 28 Oz, (8 x 18 cm), 3-1/8" x 7"



## SOAP DISH/SYRINGE STERILIZER



GS-35-347 Soap Dish/Syringe Sterilizer, size 5-1/2" x 4-1/8" x 1-1/8"

## WASH BASINS



GS-35-348 Wash Basin, Capacity 4 Qts, Size 12-3/8" x 3-3/4"

GS-35-349 Wash Basin, Capacity 4-7/8 Qts, Size 13-1/4" x 3-1/2"

## IODINE CUPS



GS-35-350 Iodine Cup, Small Capacity 6 Oz., Size 3-7/16" x 2"

GS-35-355 Iodine Cup, Large, Capacity 14 Oz., Size 4-3/4" x 2-5/8"



## NEEDLE STERILIZING CASES



- GS-35-357 Needle Sterilizing Case, Round Dia. 6.5x1.5cm Height,  
W/Perforated Inner Case  
GS-35-358 Inner Case Only Perforated

## MEDICINE CUP-GRADUATED



- GS-35-360 Medicine Cup, Graduated, 20z., Size 2-1/8" x 2"

## MEASURING BEAKERS



- GS-35-362 Measuring Beaker, Graduated, Capacity 16 Oz., 500cc 3-3/4" x 4-5/8"  
GS-35-365 Measuring Beaker, Graduated, Capacity 32 Oz., 1000cc, 4-3/4" x 5-1/4"  
GS-35-368 Measuring Beaker, Graduated, Capacity 64 Oz., 2000cc, 5-1/2" x 6-1/2"





## TRANSFER FORCEPS



GS-35-369 Transfer Forceps, Pistol Grip, Stainless Steel,  
For easy aseptic transportation to the operating field.

## KICK BUCKETS AND STAND



- GS-35-370 Kick Bucket Stand Set, Complete, Capacity 13 Qts  
Bucket Size 11-5/8" x 9-1/4", Stand Size 14" x 7-1/2"
- GS-35-370-A Kick Bucket Stand Set, Complete  
Capacity 16 quarts
- GS-35-370-B Kick Bucket, Stand Only
- GS-35-370-C Kick Bucket Only, 13 Quarts
- GS-35-370-D Kick Bucket Only, 16 Quarts
- GS-35-370-E Kick Bucket Only, 20 Quarts



## OINTMENT JARS WITH SLIP-OVER COVERS



- GS-35-371 Ointment Jars with Strap Handle Cover, 9 Oz., 3-1/8"x2-3/4"
- GS-35-372 Ointment Jars with Plain Cover, 9 Oz., 3-1/8"x2-3/4"

## SPONGE BOWLS



- GS-35-381 Sponge Bowls, Capacity 12 Oz., (11x5 cm) 4-1/4"x2"
- GS-35-382 Sponge Bowls, Capacity 22 Oz., (12.5x7 cm) 5"x2-3/8"
- GS-35-383 Sponge Bowls, Capacity 29 Oz., (14x6.5 cm) 5-9/16"x2-9/16"
- GS-35-384 Sponge Bowls, Capacity 36 Oz., (16x7 cm) 6-1/4"x2-3/4"
- GS-35-385 Sponge Bowls, Capacity 64 Oz., (19x7.5 cm) 7-9/16"x3"

## DRESSING JARS WITH SLIP-OVER COVER



- GS-35-390 Dressing Jar, Capacity 1/2 Quarts, (10.5x5.5 cm) 4-1/8"x2-1/4"
- GS-35-391 Dressing Jar, Capacity 1 Quarts, (10.5x14 cm) 4-1/8"x5-1/2"
- GS-35-392 Dressing Jar, Capacity 1-7/8 Quarts, (12.5x5.5 cm) 4-7/8"x6-1/4"
- GS-35-393 Dressing Jar, Capacity 3 Quarts, (15x17 cm) 5-7/8"x6-3/4"
- GS-35-394 Dressing Jar, Capacity 4-3/4 Quarts, (17x19.5 cm) 6-3/4"x7-3/4"
- GS-35-395 Dressing Jar, Capacity 6 Quarts, (18.5x21.5) 7-1/4"x8-3/8"
- GS-35-396 Dressing Jar, Capacity 8 Quarts, (20x25 cm) 8"x9-3/8"



## SURGICAL BOXES STAINLESS STEEL



### WITHOUT KNOB

- GS-35-406 Surgical Box with Cover, without Knob, (18x8x3cm) 7x3x1-1/4"
- GS-35-407 Surgical Box with Cover, without Knob, (20x9x5cm) 8"x3-1/2"x2"
- GS-35-408 Surgical Box with Cover, without Knob, (25x10x5 cm) 10"x4"x2"
- GS-35-410 Surgical Box with Cover, without Knob, (30x12.5x5 cm)12-"x5"x2"
- GS-35-411 Surgical Box with Cover, without Knob,(30x12.5x8 cm) 12"x5"x3"

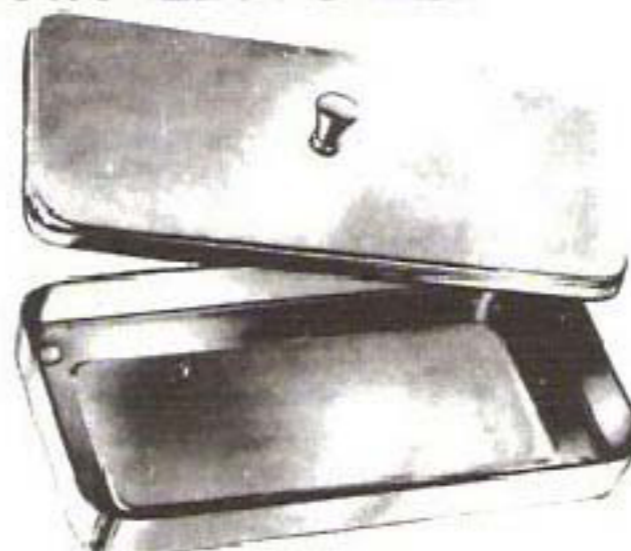

### WITH KNOB

- GS-35-412 Surgical Box with Cover, with Knob, (18x8x3cm) 7x3x1-1/4"
- GS-35-414 Surgical Box with Cover, with Knob, (20x9x5cm) 8"x3-1/2"x2"
- GS-35-416 Surgical Box with Cover, with Knob, (25x10x5 cm) 10"x4"x2"
- GS-35-418 Surgical Box with Cover, with Knob, (30x12.5x5 cm)12-"x5"x2"
- GS-35-420 Surgical Box with Cover, with Knob,(30x12.5x8 cm) 12"x5"x3"

## DRESSING DRUM



- GS-35-425 Dressing Drums, Horizontal Ventilation, (15x15 cm) 6"x6"
- GS-35-426 Dressing Drums, Horizontal Ventilation, (18x18 cm) 7"x7"
- GS-35-427 Dressing Drums, Horizontal Ventilation, (22.5x11.5 cm) 9"x4-1/2"
- GS-35-428 Dressing Drums, Horizontal Ventilation, (22.5 x 22.5cm) 9" x 9"
- GS-35-429 Dressing Drums, Horizontal Ventilation, (23x15 cm) 9"x 6"
- GS-35-430 Dressing Drums, Horizontal Ventilation, (28x24 cm) 11"x 9-3/4"
- GS-35-431 Dressing Drums, Horizontal Ventilation, (30.5x25.5 cm) 12"x10"
- GS-35-432 Dressing Drums, Horizontal Ventilation, (35.5x25.5 cm) 14"x10"
- GS-35-433 Dressing Drums, Horizontal Ventilation, (38x30.5 cm) 15"x12"
  
- GS-35-434 Dressing Drums, Horizontal Non-Ventilated, (10x10 cm) 4" x 4"
- GS-35-435 Dressing Drums, Horizontal Non-Ventilated, (10x12 cm) 4" x 4-3/4"
- GS-35-436 Dressing Drums, Horizontal Non-Ventilated, (15x12 cm) 6"x4-3/4"
- GS-35-437 Dressing Drums, Horizontal Non-Ventilated, (20x14 cm) 7-3/4"x 5-1/2"



## GALLIPOTS J-TYPE

GS-35-450	Gallipot J-Type 2 Oz.
GS-35-452	Gallipot J-Type 3 Oz.
GS-35-454	Gallipot J-Type 4 Oz.
GS-35-456	Gallipot J-Type 6 Oz.
GS-35-458	Gallipot J-Type 8 Oz.
GS-35-460	Gallipot J-Type 10 Oz.
GS-35-462	Gallipot J-Type 12 Oz.

## MIXING/SOLUTION BOWLS



GS-35-464	Mixing/Solution Bowl, Capacity 7/8 Quart, 6-5/8 x 2-1/2
GS-35-466	Mixing/Solution Bowl, Capacity 1-5/8 Quarts, 8-1/8 x 3
GS-35-468	Mixing/Solution Bowl, Capacity 3 Quarts, 9-3/4 x 4
GS-35-470	Mixing/Solution Bowl, Capacity 5 Quarts, 11-7/8 x 4-1/2
GS-35-472	Mixing/Solution Bowl, Capacity 6-3/4 Quarts, 12-3/4 x 5-1/4
GS-35-474	Mixing/Solution Bowl, Capacity 8 Quarts, 13-5/16 x 5-7/16
GS-35-476	Mixing/Solution Bowl, Capacity 13-1/2 Quarts, 16-1/4 x 6

## JAR COVERS



GS-35-478	Jar Cover, 73 mm
GS-35-480	Jar Cover, 95 mm
GS-35-482	Jar Cover, 106 mm
GS-35-484	Jar Cover, 119 mm
GS-35-486	Jar Cover, 143 mm



**SOLMANIA**  
International

Small Industries Estate- Sialkot (51310) Pakistan

Phone: 0092 (52) 3256004

E-mail: [info@solmanaintl.com](mailto:info@solmanaintl.com)

E-mail: [sales@solmanaintl.com](mailto:sales@solmanaintl.com)

E-mail: [solmanaint@gmail.com](mailto:solmanaint@gmail.com)

URL: [http:// www.solmanaintl.com](http://www.solmanaintl.com)